

SEARS ISLAND FAULT INVESTIGATION  
SEARS ISLAND, SEARSPORT, MAINE

by

John R. Rand, Consulting Geologist

Robert G. Gerber, Geologist, Central Maine Power Company

for

Maine Nuclear Power Station

Central Maine Power Company

Augusta, Maine

19 March 1976

## **Executive Summary**

During the course of geologic studies for Central Maine Power Company's proposed nuclear power plant on Sears Island in Searsport, Maine, a northeasterly trending, highly weathered rock zone was inferred about 1,000 feet (300 m.) from the reactor site. From April through November 1975, an investigation was conducted centering around two large trenches across the trend of the weathered zone. This report is a summary of the results and interpretations of the investigations performed.

The trenches exposed an ancient fault zone containing highly weathered phyllitic rock. In the more westerly of the two large trenches, this weathered rock material had locally intruded and caused minor deformation of Laurentide lodgment till. In the more easterly trench, a small bedrock reverse offset was found on the east wall with associated disturbance of overlying glacial till. On the west wall of the easterly trench, a small monoclinial flexure was found at the till/bedrock interface. The investigators conclude that the bedrock fault zone experienced its last tectonic movement in Pre-Cenozoic time. The deformation of the tills over the fault zone is interpreted to have occurred approximately 13,500 to 12,800 years ago as a result of the weaker, weathered rock having been squeezed between the adjacent harder bedrock masses. This squeezing produced either a forceful intrusion of highly weathered material into the till or an arching of somewhat more competent but still relatively weaker rock in the fault zone. The squeezing and arching was a result of 1) lateral stress relief of the harder bedrock into the softer fault zone materials during glacial unloading and/or 2) a horizontal stress against the weaker fault zone rock through southeasterly directed base shear and stress distribution from the weight of a glacial lobe advance during the final overall glacial recession. There is no evidence to indicate a tectonic origin of the till deformation.

John R. Rand, consulting geologist and Maine Certified Geologist #2, directed the investigation and mapping of the bedrock geology and is a co-author of this report. Robert G. Gerber, geologist for Central Maine Power Company and Maine Certified Geologist #110, directed the investigation and mapping of the surficial geology and is a co-author of this report. Weston Geophysical Engineers, Inc. of Westboro, Massachusetts, performed the geophysical surveys. Geotechnical Engineers, Inc. of Winchester, Massachusetts, conducted laboratory tests, described the physical properties of the surficial and weathered bedrock materials, and formulated the till deformation models. Geochron Laboratories Division of Krueger Enterprises, Inc., of Cambridge, Massachusetts, determined the radiometric age dates. Professor Gene Simmons and Dorothy Richter, then of Massachusetts Institute of Technology, performed petrographic studies.

## CONTENTS

I.	Introduction.....	1
1.	Summary .....	1
2.	Purpose and Scope of Report.....	1
II.	General Regional Geologic Considerations.....	2
1.	Introduction.....	2
2.	Geologic Setting .....	2
a.	Bedrock.....	2
b.	Surficial.....	3
3.	Regional Faults .....	3
4.	Apparent Regional Lineaments .....	4
III.	Glacial History of Sears Island.....	5
1.	Glacial Chronology.....	5
2.	Maximum Laurentide Ice Thickness .....	6
3.	Maximum Differential Rebound Rate .....	7
4.	Remaining Rebound.....	8
5.	Relative Sea Level During Laurentide Deglaciation .....	9
IV.	Trenching Program at Sears Island.....	10
1.	Basis for Program .....	10
2.	Sequence of Trench Excavations.....	10
3.	Methods .....	11
a.	Mapping.....	11
b.	Testing .....	11
4.	Primary Investigators.....	11

V.	Results of Trench Investigations.....	12
1.	Bedrock Topography .....	12
2.	Bedrock Geology .....	12
3.	Glacial Deposits .....	15
a.	General Sequence .....	15
b.	Detailed Description of Each Surficial Unit.....	16
	Units 1 and 2.....	16
	Unit 3 .....	18
	Unit 4 .....	19
	Unit 5 .....	20
	Unit 6 .....	23
	Unit 7 .....	23
	Unit 8 .....	25
	Unit 9 .....	25
4.	Faulting.....	25
a.	Bedrock Faults .....	25
b.	Deformation of Glacial Till .....	26
	Trench A .....	26
	Trench B.....	28
VI.	Geologic Interpretations of Deformational Features .....	28
1.	Bedrock Faulting.....	28
2.	Deformation of the Till .....	29
3.	Glacial Origin of Till/Bedrock Deformations.....	30
a.	Features Indicative of Non-Tectonic Origin.....	30
b.	Features Suggestive of Glacial Origin .....	31



## **FIGURES**

- Figure 1 - Regional Geologic Setting - Bedrock Map and Profile
- Figure 2 - Site Area - Magnetic Trends and Bedrock Topography
- Figure 3 - Geologic Map - Trenches A and B (Bedrock Surface)
- Figure 4 - Geologic Profiles – Trench A
- Figure 5 - Geologic Profiles - Trench B
- Figure 6 - Borings and Testpits
- Figure 7 - Plan: Photo and Sample Locations, Trench A
- Figure 8 - Sections: Photo and Sample Locations, Trench A
- Figure 9 - Photo and Sample Locations, Trench B
- Figure 10 - Regional Location

## **APPENDICES**

- Appendix A - Photos of Trench A
- Appendix B - Photos of Trench B
- Appendix C - Material Properties: Graphs and Tables
- Appendix D - “Gouge” Intrusion Models
- Appendix E - General Discussion of Glaciotectonics, Rebound Effects, and Postglacial Faulting

## I. Introduction

### 1. Summary

Two trench excavations to expose the bedrock surface of a northeasterly-trending bedrock depression on Sears Island have exposed a condition of minor local deformation of the contact between weathered phyllite bedrock and the overlying glacial till. The deformation in the first trench takes the form of a 6 inch (15 cm.) intrusion of soft, plastic weathered phyllite into lodgment till. This till is estimated to be 22,000 to 16,500 years old. The deformation in the second trench, about 200 feet (60 m.) northeast of the first, is laterally discontinuous: a 1-inch (2.5 cm.) reverse fault rupture on a limb of an arched bedrock surface occurs on the east wall, displacing a till/bedrock contact of unknown age; an unfaulted till/bedrock contact occurs on the west wall (25 feet or 8 meters to the southwest), where only the basal layers of the older till show minor crumple folding, without deformation of the bedrock surface.

The narrow zones of deformation of the till/bedrock contact in these two trenches strike about N34°E, and trend parallel with an underlying bedrock fault zone which is characterized by moderate to extreme weathering, and a broad linear bedrock depression. The sense of the till/bedrock deformation is that of a moderately southeast-dipping, reverse fault. The sense of primary displacement in the underlying bedrock fault zone appears to be that of a moderately to steeply southeast-dipping normal fault system having a slight right-lateral, strike-slip component.

A non-tectonic origin of the till/bedrock deformations is indicated by: 1) very small size relative to the substantial width and length of the underlying bedrock fault zone; 2) the sense of compressional deformation in a geologic terrane interpreted to be subject to regional crustal extension; 3) a single small deformational event in at least the last 22,000 years; 4) the deformational effects in the deeper and presumably older till are less intense than those in the upper till; and 5) the lack of continuity of the deformation along the till/bedrock interface along the fault.

The preponderance of evidence indicates that the origin of the deformations of the till/bedrock contact in the weathered bedrock fault zone is ascribed to 1) the lateral relief of stress that had been imparted to the bedrock under the loading of the last Wisconsinan continental ice sheet, with stress relief effected by the movement of hard bedrock into the zone of soft weathered bedrock materials; and/or 2) lateral stress against the weaker fault zone rock through southeasterly directed base shear and stress distribution from the weight of a glacial lobe advance just to the northwest of the fault zone. The time of deformation may be interpreted from regional considerations to have been about 13,500 to 12,800 years ago.

### 2. Purpose and Scope of Report

Appendix A of Part 100 of Title 10 of the Code of Federal Regulations requires detailed geologic investigations in the vicinity of proposed nuclear power plant sites. Where faulting is known or suspected, these investigations must determine the approximate extent and date of last movement of these faults. Part of the fault investigations at the proposed Sears Island nuclear plant site involved the excavation of two large trenches over a suspected fault zone about 1000 feet from the proposed reactor. The basic intent of the report is to present the evidence and reasoning

leading to the conclusion that a disruption found at the till/bedrock interface is related to glacial forces. This report summarizes all data that were developed by Central Maine Power Company and its consultants during the detailed investigations of the fault zone on Sears Island. Information from other general geologic investigations not specifically related to the trenching program is included where it enhances the understanding of the geologic context of the features in the fault zone.

The report is organized to: 1) give a concise description of the features of concern and the reasoning for why these features are not considered to represent recent "tectonic" faulting; 2) provide a general description of the regional geologic setting; 3) provide a detailed discussion of the glacial history of the Sears Island region; 4) describe the sequence of events leading to the discovery of the Sears Island fault zone and the disruption of the till/bedrock interface; 5) describe the methods and people involved in the trenching studies; 6) provide a detailed discussion of the bedrock and surficial deposits found in the trenches; 7) describe the bedrock faults and the glacial till deformation and their probable mechanisms; and 8) summarize the evidence supporting the concept of a glacial-related origin of the till/bedrock deformation.

All literature and personal references are listed at the end of the report. Figures that portray the features discussed in the report are provided. Appendices A and B contain 68 color photographs taken of representative or significant geologic features in the trenches. Appendix C presents tables and graphs of laboratory tests performed by Geotechnical Engineers Inc. on materials from the trenches. Appendix D summarizes the two idealized mathematical models that represent potential mechanisms that created the till/bedrock interface deformations in Trenches A and B. Appendix E is a generic discussion of glaciotectonics, rebound effects, and postglacial faulting and is intended as background information concerning types of apparent ground disturbance that can be attributed to glacially-induced stress or stress relief.

## II. General Regional Geologic Considerations

### 1. Introduction

The information in this Section II is provided to give the reader a background on the geology of the Sears Island region. Particular faults, lineaments, and other features mentioned are not necessarily related to specific features found on Sears Island, but are intended as examples of the major geologic changes that have taken place in the area. At the time these investigations were performed, the best source of information on the geology of the region in the vicinity of the site was: Guidebook for Field Trips in East-Central and North-Central Maine; Philip H. Osberg, Editor; 66<sup>th</sup> Annual Meeting, New England Intercollegiate Geological Conference, Orono, Maine; October 12-13, 1974.

### 2. Geologic Setting

#### a. Bedrock

The site is situated within the Maine Coastal Anticlinorium geologic province, on chlorite-grade phyllitic rocks of the Penobscot formation of presumed Ordovician age (Figure 1). The Coastal Anticlinorium province is characterized generally as an uplifted

segment of Precambrian to Devonian metamorphic rocks consisting largely of schists, gneisses and quartzites, with local occurrences of metamorphosed carbonate rocks and volcano-clastic sequences. The province has been intruded by numerous large masses of Middle Devonian (Acadian) felsic plutonic rocks, and by several smaller, slightly older mafic plutons. Basic dikes of Paleozoic and Mesozoic age have intruded the country rock throughout the area. The youngest dikes known in the area are lamprophyres exposed at Jameson Point, Rockland, 25 miles to the south-southwest of the site, with potassium argon dates of Middle to Late Cretaceous Age (Site D, Figure 1).

The Coastal Anticlinorium province is bounded on the northwest, about 13 miles from the site, by the Norumbega fault system of Late Devonian to Carboniferous age. Pelitic Siluro-Devonian metamorphic rocks of the Merrimack Synclinorium lie to the northwest of the Norumbega fault system; wedges of post-orogenic sandstones and conglomerates occur within and to the north of the fault zone.

#### b. Surficial

The Surficial deposits of the Searsport area were primarily created by the Laurentide (Late Wisconsinan) glaciation although it is theoretically possible that interglacial deposits of Early Wisconsinan or older age might be found in bedrock troughs. Bedrock is usually mantled by a ground moraine of variable thickness. In the Searsport area, the ground moraine is a dense till with a fine grained clay-silt matrix overlain by a loose, thin ablation till. Lodgment till was created and overridden by glacial movement from the north-northwest. Prescott (1966) states that the predominant direction of glacial striae in the Lower Penobscot Valley is S10-15°E. Measurements on Sears Island by the authors of this report are S20-25°E. The ground moraine is intermittently overlain by ice contact sand and gravel and glacio-marine fine sands, silts and silty clays (the Presumpscot Formation) deposited during glacial recession. The upper marine limit for the area, based on the highest position of marine terraces of the Presumpscot formation is 280 to 300 feet above present mean sea level. Many of the ice contact deposits in the Maine Coastal area are inter-tongued with marine deposits, indicating that the sea was directly against a fluctuating ice margin (Stuiver and Borns, 1975). Morainal deposits and overridden marine deposits also indicate that several re-advances occurred during the overall recession. Recent sediments derived from the erosion and re-working of glacial deposits occur as sand and cobble beaches, silty tidal flats, and sand and silt floodplain and fluvial deposits. Peat accumulations have formed in tidal marshes, kettle ponds, and poorly drained swamps in the upland areas. The Laurentide glaciation began about 22,000 B.P., reached its peak about 18,000 B.P., and had receded to the Sears Island area by 13,000 B.P. Rapid land rebound caused sea level to drop to its present relative level in the Searsport area by about 12,200 B.P.

### 3. Regional Faults

The fault system that is reported to occur nearest to the site (Figure 1) is the Turtle Head fault (Stewart; 1974). This fault system is interpreted to bracket Islesboro, and its western trace (high-angle, right-lateral, strike-slip) is interpreted to swing around Turtle Head, Islesboro, and to trend

northeasterly into Wilson Point, Penobscot, passing about 2 miles (3.2 km.) to the southeast of the site. Geologic and radiometric evidence indicates that the Turtle Head fault, which displaces Lower Devonian volcano-clastics and is terminated by the Middle Devonian Lucerne pluton, is on the order of 370 to 390 million years old.

The second known fault system of regional extent in the site area is the Norumbega fault (Stewart & Wones; 1974), which passes northeasterly through Brooks and Frankfort, about 13 miles (21 km.) to the northwest of the site. Wones (1975a) interpreted this fault to exhibit a high-angle, right-lateral strike-slip displacement of at least 15 miles (24 km.), with an age younger than 369 million years. Regional comparisons of the Norumbega fault with apparently similar faulting in New Brunswick suggest that the fault is older than about 230 to 270 million years (Belt; 1968).

The last period of major tectonic faulting in the New England region is generally held to be of Triassic age, 180 to 200 million years ago. The last episode of regional intrusive activity, accompanied by at least local faulting, is that which emplaced the Jurassic-Cretaceous White Mountain and Monteregeian Hills plutonic series in central New England and eastern Quebec, from about 180 to less than 100 million years ago. The small swarm of very fresh lamprophyre dikes that intrude ancient schists at Jameson Point, Rockland (Figure 1, Location "D") have produced two rather disparate dates at 69 and 110 million years, suggesting at least a temporal relationship with the Cretaceous intrusive activity of the region.

At this time, it is not known if the fault on Sears Island is related to any of the known regional fault systems.

#### 4. Apparent Regional Lineaments

There are numerous northwest- and northeast-trending linear elements seen on ERTS photos, aerial photos and physiographic maps of the site region. The trend of the Norumbega fault, following a train of valleys bounded by substantial hills or ridges, is fairly prominent. The trend of the Turtle Head fault in the land area to the east of the site is an apparent, but very weak lineament.

A prominent ERTS and physiographic lineament of the region (Figure 1, Line "A") is the 20-mile (32 km.) long topographic trough that trends about N28°E through the Bucksport formation from the vicinity of Orland, 10 miles (16 km.) northeast of the site. Wones (1975b) relates this feature to the carbonate isograd in the contact aureole of the Lucerne pluton, and notes that in detail the linearity of the physiography is more apparent than real. Sweeney (1976) notes the presence of a fabric of healed fractures along the northwest contact of the Lucerne pluton within the granite; this condition may have aided in the differential erosion of the prominent topographic trough in the area.

In the 10-mile (16 km.) distance northeasterly between the site and Orland, infrared aerial photos flown for site study purposes show (Figure 1, Line "B") some short, unexplained, northeasterly-trending linear elements on Cape Jellison, 1½ and 3 miles (2.4 and 4.8 km.) northeast of the site; on Sandy Point, 5½ miles (8.8 km.) northeast of the site; and on Verona Island, 8 miles (13 km.) northeast of the site.

In the area for about 3 miles (5 km.) to the southwest of Sears Island (Figure 1, Line "C"), J. Rand has interpreted offshore reflection seismic and magnetometer profiling done by Weston Geophysical Engineers, Inc., to show an apparent correlation between a somewhat sinuous relative magnetic low anomaly with a series of locally discontinuous depressions in the bedrock surface, in a zone that trends N25°-35°E into the southwest shoreline of the island.

At this time it is not known if any of these regional lineaments can be correlated with the Sears Island fault zone.

### III. Glacial History of Sears Island

#### 1. Glacial Chronology

The determination of the time period in which the single till/bedrock contact deformation in Trenches A and B on Sears Island occurred is dependent on a knowledge of the age of the till in the bottom of each trench. Some of the age assumptions of the surficial deposits in Trenches A and B on Sears Island are speculative and based on regional correlation with deposits of known ages in other areas. This section describes that which is known about the ages of the individual glacial periods and associated deposits in North America, particularly Maine.

The surficial geology of Sears Island is a product of multiple glacial overrides, all of which are likely associated with the Laurentide advance, but no dates exist for the material located beneath a dated glaciomarine deposit sandwiched between distinct till units. Andrews (1974) suggests that there were 8 glaciations of the Hudson Bay area. Based on drift sequences, Kaye (1964) has inferred 7 major glacial advances as far south as Martha's Vineyard. Kaye (1961) also found 4 major drifts and 3 clay deposits in the Boston Basin that he considers to be as old as Kansan or Nebraskan. Caldwell (1959) identified two tills at New Sharon, Maine. Borns (1975) has since dated organic matter in a soil horizon of the lower till at greater than 52,000 years old. Borns (1975) also stated that work at New Sharon suggests the possibility of a third, older till. The multiple drift sequences of the Great Lakes and Mid-West area, as shown on The Glacial Map of the United States East of the Rocky Mountains (1959), are well known. There are also multiple glacial striae at various locations in New England (e.g. Leavitt and Perkins, 1935), which indicate that ice advanced from slightly different directions at different times.

The major influence on surficial geology was the period of the Laurentide Ice Advance and Recession (Late Wisconsinan). This last major glaciation is estimated to have begun about 22,000 years ago in the Sears Island area. At this time, Lake Erie Basin became covered (Dreimanis and Karrow, 1972) and the last major advance of the Weichselian Glaciation began (Mörner, 1972). Schafer and Hartshorn (1965) state that the horn of an extinct bison was found in till near Harvard, Massachusetts, with a <sup>14</sup>C date of 21,200 ± 1000 B.P. The Laurentide Sheet reached its maximum extent approximately 180 miles (300 km.) SSE of Sears Island (Schlee and Pratt, 1970; Fillon, 1972) about 17,000 to 19,000 years B.P. (Broecker, 1965; Fillon, 1972; Flint, 1956; Newman, et. al. 1971; CLIMAP, 1976). Curray (1965) shows the lowest Late Wisconsinan eustatic sea level about 18,000-19,000 B.P.; however, Milliman and Emery's (1968) preferred eustatic sea level curve has its lowest point about 15,000 B.P. Eustatic sea level curves, however, reflect worldwide water-ice balance and may not necessarily correlate directly with the states of Laurentide glaciation.

During the retreat of the Laurentide ice sheet, there were many ice lobe fluctuations in the New England coastal area. A significant interstadial occurred between 15,500 and 16,500 B.P., (Mörner, 1972). During this period, the ice retreated to the east end of Lake Erie basin (Dreimanis and Karrow, 1972), before readvancing again more than 60 miles (96 km.), (Goldthwait, Dreimanis, and others, 1965). A "gyttja" (freshwater mud with organics) was deposited at St. John, New Brunswick, about  $16,500 \pm 320$  B.P. (Mörner, 1972) before readvance. Retreat occurred in New York and Pennsylvania before forming the Valley Head Moraine  $14,900 \pm 450$ . Recessions occurred in Lake Michigan and in Washington State followed by readvances about 15,000 years ago. Kaye's (1964) date of  $15,300 \pm 800$  B.P. on tundra flora at Zacks Cliff on Martha's Vineyard in clay overlain by sand that is nearby overlain by another till, indicates a retreat, then readvance about this time. This time period coincides with the radiocarbon date of  $15,595 \pm 400$  B.P. on calcium carbonate accretions in the marine unit on Trench B of Sears Island. This requires a major ice retreat to the middle coastal portion of Maine (about 180 miles (300 km.) from its maximum extent) in a period for which no other radiocarbon dates have been found in Maine. The next youngest date is the Pond Ridge Moraine in Cutler, Maine,  $13,320 \pm 200$  B.P. (Stuiver and Borns, 1975). The calcium carbonate forming the accretions on Sears Island may have been partially composed of leached carbonates from older materials, thereby producing a radio-carbon date older than the deposit itself.

Most of the Maine dates (Stuiver and Borns, 1975) indicate that the major retreat in the coastal area including Sears Island occurred during the period 13,500 to 12,700 years B.P. Many small advances and retreats occurred in a belt along the coast about 18 miles (29 km.) wide, leaving multiple sets of striae on exposed bedrock and many end moraines, washboard moraines and ice contact deposits. Since the relative sea level was at its maximum when the ice front was near the coast, fine grained marine sediments (called the Presumpscot Formation by Bloom, 1963) were deposited in the sea in front of the retreating ice. These deposits were occasionally overridden by minor advances. In eastern Maine, the last of the major readvances was terminated at Pineo Ridge about 12,700 B.P. after a 48 mile (80 km.) retreat (Borns, 1974). There is no evidence that this advance extended to Sears Island.

Once the marine invasion reached its maximum extent in interior Maine about 12,500 years ago, the ice sheet thinned, separated and stagnated over the Longfellow and Boundary Mountains of western Maine (Borns and Calkins, 1970).

## 2. Maximum Laurentide Ice Thickness

The "gouge" intrusion in Trench A and the arching of the bedrock in Trench B can logically be ascribed to a lateral relief of stress from hard bedrock on either side of the Sears Island fault zone upon melting of the continental glacier. The amount of "gouge" rise or bedrock arch is a function of the original maximum confining stress from the weight of the glacier. Computation of the maximum stresses under the Laurentide glacier at Sears Island requires an estimate of the approximate thickness of the ice. Various estimates of the Laurentide ice thickness at its maximum in Hudson Bay range from 8,200 feet to 13,100 feet (2500 to 4000 m.). Farrand (1962) estimates that the ice was 10,000 ft. (3050 m.) thick in the Great Lakes area. Since the top of Mt. Katahdin in northern Maine had been glaciated, Caldwell (1959) assumed that the ice was greater than 4700 feet (1430 m) thick in that area. Stuiver and Borns (1975) infer that at its

maximum, the New England ice sheet must have been about equal to the 7200 foot (2200 m.) thickness of the present Greenland and Antarctic ice caps. Chapman (1970) found that Cadillac Mountain on Mt. Desert Island, 30 miles (48 km.) to the east of Sears Island, was completely covered by ice, indicating that the ice was greater than 1530 feet (466 m.) thick there.

Stuiver and Borns (1975) calculated the maximum ice thickness in "interior" Maine (42 miles or 70 km. up-glacier from Sears Island) during deglaciation approximately 13,000 B.P. Using Broecker's model (1966) with rebound half-response times from 700 to 1500 years, Stuiver and Borns derive a 4600-6560 foot (1400-2000 m.) ice thickness. Newman et. al. (1971) state that 50% of the Laurentide ice volume had already disappeared by this time. If the Laurentide advance did extend 180 miles (300 km.) south of Sears Island as suggested by Schlee and Pratt (1970), then it seems reasonable to assume that the Laurentide ice was at least 3600 to 5250 feet (1100 to 1600 m.) thick over Sears Island at maximum ice stage. This is conservatively computed by assuming a linear ice slope from "interior" Maine to the ice front and finding the thickness at Sears Island proportionately. According to the parabolic equation that describes the thickness of a glacier with distance from the ice front, (Mellor, 1976) the thickness at Sears Island would be about 9000 feet (2700 m.), however, this is a greater thickness than most investigators have inferred. The linear approximation has therefore been adopted for the sake of conservatism. It also brackets the value of maximum Laurentide ice thickness at Sears Island as depicted on the map in CLIMAP (1976) --1500-1600 meters.

### 3. Maximum Differential Rebound Rate

This section provides background on the nature of the earth's response to glacial loading and subsequent unloading. The flexure of the earth that takes place can contribute to the forces generating the "gouge" intrusion and bedrock arching at the till/bedrock interface over the weathered fault zone.

As discussed below in Section III.5, rapid uplift occurred in the 1000 years immediately following deglaciation. Rates as high as 2 ft. (0.6 m.) per year can be estimated from uplift curves (Farrand, 1962), and it is conceivable that even higher rates could have occurred. McDonald (1967) references tilted glacial lake surface gradients in New England: 4-4.5 feet/mile in the Merrimack River Valley, New Hampshire, and in the Connecticut River Valley; 5-6 feet/mile near Concord, Massachusetts; and 5.3 feet/mile for the Fort Ann phase of Glacial Lake Vermont. It seems reasonable to assume that a north-northwesterly tilt of 5-6 feet/mile or about 1 meter per kilometer occurred over the Sears Island region.

Flexure of the earth's crust occurred during both loading and unloading by the ice. As the ice sheet expanded in size, the earth's crust was depressed elastically, and viscous and plastic outward flow in the earth's crust and mantle were initiated. The relative percentages of depression that take place due to each process, and the maximum slope of flexure that occurs near the surface may be estimated using loading response models, loading assumptions, and estimated physical properties of the earth. Although most of the models fit the existing data from measurements of upwarp on proglacial lakes, they differ in major assumptions concerning the earth's response mode. Most models, such as given by Newman, et. al. (1971), call for a "forebulge" to develop during loading that would eventually subside or migrate inward during deglaciation. Some models such as that given by Broecker (1966) do not predict a forebulge. In



Broecker's model, the maximum flexure occurs near the ice front. For a rate of retreat of 380 feet (120 m.) per year and an interior ice thickness of 7200 feet (2200 m), a maximum earth slope of about 8 feet/mile (1.5 m./km.) is calculated. This value is of the same order as the measured slopes of tilted glacial lake planes. The forebulge models also generate maximum flexures of the same order.

#### 4. Remaining Rebound

This report describes a till/bedrock contact deformation that is ascribed to the relief of stresses that were created by glacial forces. Rebound of glaciated areas is the only remaining form of glacial stress relief. This section describes how the remaining stress relief (rebound) is very small and not of the magnitude required to generate any differential movement in or adjacent to the Sears Island fault zone.

In Section III.5 below, the minimum total isostatic depression from the Laurentide Ice in the vicinity of Sears Island is estimated to be 470 to 633 feet (143-193m.), which agrees favorably with Andrews (1974) who has found a range of deflections at the ice margin of 230 to 670 feet (70 to 200 m.). Some of the depression of bedrock under the ice was elastic, some resulted from viscous creep and some from plastic flow.

Contours on the surface of the geoid shown in King (1965) show a pattern of depression conforming to the pattern of the Laurentide glaciation. The Hudson Bay area, which was the center of the ice mass, is a negative 50 feet (15 m.); the Sears Island area is a positive 33 feet (10 m.). The smoothed free air anomaly map of northern North America shown in Walcott (1969) shows negative gravity anomalies in the central ice sheet areas and positive anomalies near the former ice margins. Readings as low as -50 milligals occur in Hudson Bay; a positive 5 milligals is found in the Sears Island area. Walcott has interpreted these negative anomalies to suggest there is 820 to 1475 feet (250-450 m.) of remaining rebound in Hudson Bay. Andrews (1974) points out, however, that since the Hudson Bay area has undergone as many as eight glacial loading cycles, the large negative anomalies reflect the plastic nature of the mantle with complete recoveries not occurring during the interglacials. This would have resulted in a large deficiency of mass since plastic deformation is not fully recoverable upon unloading. Andrews also mentions that Broecker believes that some of this apparent volumetric change may be permanent depression due to phase changes in the earth's crust.

Tide gauges in Hudson Bay, Canada, and work in Fennoscandia with both tide gauges and precise leveling suggest that rebound is still occurring at the rate of about 3.3 feet (1 m.) per century near the center of the Laurentide ice mass. Kupsch (1967) and others have questioned whether this relative land rise is due to glacial rebound or to other longer superimposed epeirogenic movement.

Even if there is a measurable amount of isostatic adjustment still occurring from the Wisconsinan glaciation, the magnitude of remaining rebound at Sears Island is very small. Brothie and Silvester (1964), whose model of glacial rebound agrees quite well with available data, calculate that 60 feet (18 m.) of rebound is left in the Hudson Bay area but only 0.5 feet (0.15 m.) left at Sears Island, 900 miles (1450 km.) from the ice center. This calculation employs the basic exponential rebound function,  $U=U_0e^{-kt}$ , where  $U_0$  is the total post glacial uplift in feet,

t is the time since deglaciation in years, and k is a rebound constant derived from analysis of uplift curves. Note that the half response time of rebound is related to k:  $t_{1/2} = (\ln 2)/k$ . Brotchie and Silvester find the rebound constant that best fits the observed data corresponds to half response times of 1070 to 1540 years. Using a half response time of 1540 years, they calculate that the present uplift rate at Sears Island is 0.02 feet (0.006 m.) per hundred years. If the total rebound at Sears Island since the Late Wisconsinan retreat is assumed to be 492 feet (150 m.), the present uplift rate is found to be 0.056 feet (0.017 m.) per hundred years. A half response time of 1070 years and a total uplift of 492 feet (150 m.) give a present rate of uplift of 0.007 feet per hundred years.

It is clear that the amount of rebound remaining at Sears Island is very small and it is being released at a very slow rate. If the free air anomaly maps or the geoid surface contour maps have any correlation to remaining rebound, they would suggest that there is little if any rebound left at Sears Island. Although rebound may have caused differential movement along weak crustal zones immediately following glacial retreat, it is not considered capable of producing differential movement along fault zones in the Sears Island region today.

##### 5. Relative Sea Level During Laurentide Deglaciation

One of two possible models that describe the mechanism of the till/bedrock deformation in the trough of the Sears Island fault requires the presence of an ice mass just to the northwest of the fault zone with the area to the south relatively free of ice. Corroboration of this condition is indicated by the presence of an ablation till grading southward over the fault zone into an outwash. The origin of the stratified sand and gravel strata near the top of Sears Island is related to the relative position of sea level in this location at the time of final ice retreat. The character and height of the actively retreating ice front is also dependent on relative sea level position since calving is produced with the sea against the ice. Since the ice margin receded to Sears Island between 12,800 and 13,500 B.P., it is particularly important to determine relative sea level position at this time. It can be estimated by studying radiocarbon dates in the coastal area and by relating land downwarp and eustatic sea level at the time of deglaciation.

Stuiver and Borns (1975) have calculated that downwarp in "interior" Maine was 625 to 785 feet (190 to 240 m.) about 13,000 B.P. based on an assumed upper marine limit of 445 feet (135 m.), and eustatic sea level at that time between -180 feet (-55 m.) (Curry, 1965) and -345 feet (-105 m.) (Milliman and Emery, 1968). Using the same method and assuming the upper marine limit near Sears Island was 290 feet (88 m.), the residual downwarp is calculated at 470 to 633 feet (143-193 m.). It was, in fact, probably greater than this since some uplift had already taken place by 13,000 B.P. – half the Laurentide ice volume had dissipated by this time.

Although eustatic sea level was rising at a rate of about 0.03 to 0.06 feet (0.01 to 0.02 m.) per year at 13,000 B.P. (Curry, 1965; Milliman and Emery, 1968), rebound was occurring at a rate of at least 0.16 to 0.32 feet (.05 to 0.1 m.) per year. This is derived by assuming total downwarp of 490 feet (150 m.) and  $t_{1/2}$  (half-life of postglacial uplift curve during which time 50% of the remaining rebound will occur) of 750 to 1500 years. Since the major portion of the rebound occurred just after deglaciation, about 13,000 B.P.,  $(\frac{1}{2} \times 150 \text{ m})/750 \text{ yr.} = 0.1 \text{ m./yr.}$  for 750 years half-response time (0.05 m./yr. for 1500 years half-response time). This is just an average rebound rate for the first 750 (or 1500) years following deglaciation but it compares well with

Wilson (1968) and Kaye and Barghoorn (1964). Of course, the instantaneous rebound rate is even greater immediately after deglaciation and uplift rates of as much as 2 feet (0.6 m.) per year have been estimated (Farrand, 1962).

Since the earth was rising faster than eustatic sea level by a factor of at least 5 to 10 and possibly as much as 30 to 60 in early stages of deglaciation, a relative sea level of 290 feet (88 m.) higher than present must have occurred as the ice was receding. Thus, Sears Island (elevation 195 feet) must have been totally below sea level at the time the ice margin receded to this vicinity.

By approximately 12,200 B.P. (Stuiver and Borns, 1975) the relative sea level at Sears Island had dropped to near its current position and was still dropping. Thus the total time of submergence was about 600 to 1300 years.

#### IV. Trenching Program at Sears Island

##### 1. Basis for Program

J. Rand's analysis of offshore geophysical surveys and onsite magnetometer and refraction seismic surveys provided by Weston Geophysical Research, Inc., coupled with his study of cores of 35 Phase I core borings drilled at wide intervals in the general site area, suggested early in 1975 that a linear depression in the bedrock surface may extend discontinuously from beneath Penobscot Bay some 2 miles (3.2 km.) to the southwest of the site in a northeasterly direction to and across the southern portion of Sears Island (Figure 1, Line "C"). A relative magnetic low anomaly is frequently associated with this apparent depression (Figure 2, Insert). On Sears Island the bedrock depression is characterized by locally deep bedrock weathering and a broad magnetic low anomaly (Figure 2). Cores from the few borings put down in the area of the bedrock depression on the island suggested anomalous fold deformation, pyrite mineralization and quartz veining in the phyllite bedrock in this zone which might indicate the presence of a bedrock fault zone.

This zone is the most site-significant bedrock geologic feature interpreted from the preliminary studies, and since the bedrock is not exposed for direct observation along the zone, a trench was excavated to expose and examine the bedrock surface of the depression in an area where the depression was buried beneath the least thickness of glacial overburden.

##### 2. Sequence of Trench Excavations

During 8 months of 1975, two trenches, "A" and "B", were excavated through unconsolidated glacial overburden to expose and examine the bedrock surface in the trough of the bedrock depression in the south central part of Sears Island (Figure 2). Trench A was excavated to bedrock during April and May, adjacent to Stations 19 to 21 on Seismic Line 23, where the bedrock trough was interpreted to be relatively shallow. A further excavation to a depth of about 13 ft. (4 m.) below the bedrock surface in the trough was completed during the week of October 6th.

Trench B was excavated to bedrock during the summer months in an area about 200 ft. to the northeast of Trench A, adjacent to Stations 14 to 18 on Seismic Line 27, where the bedrock was

interpreted from geophysical surveys to be 30 feet (9 m.) or more deep. In Trench B, a further excavation to a depth of 6-9 ft. (2-3 m.) below the bedrock surface was completed during the week of November 3rd.

### 3. Methods

#### a. Mapping

Ground control was provided by Central Maine Power Company surveyors, who outlined the trench excavations and provided spot locations and elevations for benches and for specific points ("nails") used for detailed mapping control by the geologists. All elevations are referred to Mean Sea Level. The geologists' detailed bedrock and overburden plan and profiles were controlled by taping from these nails. Orientation of bedrock structures was measured by Brunton compass. All bearings are referenced with respect to Maine Grid North which is approximately 5 minutes east of True North. Mapped sections and other features of geologic interest were photographed in color by the geologists using Canon cameras with either 24 or 35 millimeter (wide-angle) lenses. More than 800 color slide photographs were taken for the record in the trenches.

#### b. Testing

During the trench mapping program, representative rock and soil samples were selected for specific types of analyses. Except where special features were being studied, all sample locations were chosen to be generally representative of the particular unit sampled. J. R. Rand selected rock samples as shown in Figures 7, 8, and 9 for petrographic analysis or radiometric age dating. R. G. Gerber selected soil and certain "gouge" sample locations, and Geotechnical Engineers, Inc. (GEI) removed these samples and performed the laboratory analyses specified by R. G. Gerber. Undisturbed samples collected by GEI were carefully carved out of the sample location, wrapped in cheesecloth and waxed in the field. Sample locations were tied into points located by the surveyors. All samples and sample locations were photographed. A Brunton compass was used to measure the dip and strike of the oriented samples.

Laboratory testing by GEI conformed to ASTM specifications except for the rotation shear tests which followed the procedures developed by LaGatta (1970). Thin sections of phyllite and grain mounts for various size fractions of the glacial till were prepared and described with the aid of a petrographic microscope.

Colors of soil were described using the Munsell color chart as a reference.

### 4. Primary Investigators

Robert G. Gerber, Geologist  
Central Maine Power Company  
Augusta, Maine 04330

Surficial Geology

John R. Rand, Consulting Geologist

Bedrock Geology

Cundy's Harbor RD2-210A  
Brunswick, Maine 04011

Weston Geophysical Research, Inc.  
P.O. Box 550  
Westboro, Massachusetts 01581

Geophysical Surveys

Geotechnical Engineers, Inc.  
1017 Main Street  
Winchester, Massachusetts 01890

Laboratory Testing and Formulation of Till  
Deformation Models

## V. Results of Trench Investigations

### 1. Bedrock Topography

The insert on Figure 3 defines J. Rand's interpretation of the topography of the bedrock surface between Trenches A and B as projected from known elevations in the respective trenches. The essential features of the bedrock topography in this area are the relatively steep ( $\approx 30\%$ ) northwest slope and moderately steep ( $\approx 15\%$ ) southeast slope of the bedrock trough, each held up by fresh phyllite bedrock. Between these hard bedrock ridges is sandwiched a gently curving subhorizontal surface of low elevation underlain by bedrock which has been physically degraded and weakened by weathering processes. The hard bedrock of the ridges is characteristically somewhat rust-stained on joints and foliation planes, while the weathered bedrock in the topographic depression is not rust-stained and contains fresh, sparkly pyrite cubes and veinlets.

Zones of maximum incompetence of rock materials in the bedrock troughs of each trench, as indicated by the relative ease with which the backhoe was able to dig downward into the rock, occurred in the specific areas characterized on the Figure 3 insert as "gouge" in Trench A and "ruptured till" in Trench B. Blocks of felsic dike material enclosed in the phyllite bedrock were also incompetent and easily excavated, regardless of their geographic location in the trenches.

### 2. Bedrock Geology

The bedrock of the site is sub-black, very fine-grained, well-foliated phyllite of the Penobscot formation. The phyllite, which has experienced chlorite-grade metamorphism, is composed largely of muscovite, chlorite and quartz, with an appreciable content locally of pyrrhotite and pyrite, and a small amount of calcite or other carbonates. In some areas the phyllite is interbedded with thin quartz-muscovite-chlorite metasiltstone or fine quartzite beds. Quartz streaks, veins and irregular masses are common. One or more intensely altered felsic dikes (with low quartz content) occur as large masses or distinct isolated blocks in the trough of the bedrock

depression exposed in Trenches A and B. In Trench A, angular masses of felsic dike material occur as discrete blocks displaced by bedrock fault planes (Photo A-13).

The phyllite of the site has been deformed by at least two episodes of folding; the dominant foliation strikes N20-40°E and dips steeply, predominantly to the southeast. The youngest cleavage, which strikes about N5°E and dips nearly vertically, appears to deform neither the felsic dikes of the trenched bedrock trough nor a separate thin metabasalt dike which is exposed on the southwest shore of the island, about 2400' (730 m.) southwest of Trench A. The altered felsic dike material in Trench B produced a minimum age (K-Ar) of  $283 \pm 12$  million years (Sample TR-B3); the basalt dike on the shoreline produced a minimum age (K-Ar) of  $228 \pm 9$  million years (Sample 12C-B).

With the exception of the zone in the trough of the bedrock depression, the bedrock of the trenched area (Figure 3) conforms in lithology and fundamental structure with that mapped at natural outcrops on the southwest and east-central shorelines of Sears Island, where foliation dips steeply, and commonly strikes N20-40°E, and the late cleavage strikes around N5°E and dips nearly vertically. Late folding plunges gently to moderately to the north, roughly parallel to the strike of the late cleavage. Folded quartz veins and thin stringers strike variously toward the north, northeast and west-northwest. Jointing is not prominent, and is characterized by short, discontinuous, steeply-dipping joints which strike northwest to west-northwest, normal to the strike of foliation. Near the south end of Trench B, the phyllite contains very thin interbedded metasiltstone layers which strike east northeasterly, transverse to the northeasterly trend of foliation.

Phyllite bedrock in the trough of the bedrock depression contains, in both trenches, masses and blocks of light tannish-gray felsic dike material which has been too extensively altered chemically to permit identification of the original rock type (Figures 3, 4, and 5; Photos A-4, 5, 12, 13, 15; Photos B-3, 8). Essentially fresh cubes of pyrite are disseminated throughout this weathered material. Sericite in a sample of felsic material from Trench B (Sample TR-B3; Figure 9, Plan) has been dated (K-Ar) at a minimum age of  $283 \pm 12$  million years. Petrographic examination of this sample has failed to reveal any foliation or other evidence of metamorphic compressional deformation since its emplacement. The only other occurrence of possibly comparable felsic material known on the site is at 152.0' to 162.8' (46.3-49.6 m.) depth in boring B-106, about 1400' (425 m.) northeast of Trench B (Figure 6). This boring is essentially on strike with the bedrock fault zone identified in the troughs of Trenches A and B.

In the trough of the bedrock depression, in a zone about 55' (17 m.) wide in Trench A and about 150' (45 m.) wide in Trench B (Figure 3, Insert), the bedrock has been extensively weathered, and has been deformed structurally by both low- and high-angle glaciotectionic thrusting (A-2, 4, 15; B-3, 8), and, locally, by bedrock faulting (Photos A-12, 13, 15). In the trough of Trench A and both in the trough and on the higher bedrock slopes of Trench B (Figure 3), zones of soft, plastic, sub-black, very fine-grained "gouge"-like material occur in the bedrock (Photos A-1, 2, 3, 6, 7, 8, 9, 10, 11, 12, 13, 14; B-4). This material (referred to throughout this report by the term "gouge") is seen in numerous instances to have been created by the passive, in-place extreme weathering and disintegration of phyllite. Phyllite "gouge" material is also seen to have

developed passively by the weathering of isolated blocks of phyllite drift enclosed in a glacial till matrix.

Several samples of the "gouge" in Trench A were taken by GEI for various tests. Samples of adjacent phyllite bedrock were also taken so that comparison of thin sections of the "gouge" and the bedrock could be made. Table C-6 and Graph C-20 display the results of index tests on the "gouge" samples tested. Graph C-13 has a grain size analysis of several "gouge" samples. The texture and physical properties of the "gouge" is quite variable depending upon the percentage of quartz fragments, chlorite content and graphite content. The "gouge" has a lower shear strength than the intact phyllite or the till. The peak friction angle of "gouge" in direct shear is about 37° (in one sample) and the residual friction angle obtained by rotation shear tests ranges from 12° to 22° depending on the content of bulky grains, such as quartz.

Table C-9 contains the results of rotation shear tests performed on "gouge" samples to determine the approximate level of stress required to produce slickensides. Sample 26 from Trench A had developed slickensides after it was subjected to 12 inches (30 cm.) displacement, a normal stress of 283 psi (20 kg/cm<sup>2</sup>) (See Photo A-29). Sample 25 developed fabric orientation but not slickensides with a 3.9 inch (9.9 cm.) displacement at 213 psi (15 kg/cm<sup>2</sup>). In-situ stresses of over 300 psi and displacements of a few inches would probably be required to create slickensides in Sample 25. Since the "gouge" would show slickensides if sheared at stresses above 300 psi and since they were not observed in the "gouge" intrusion in Trench A, the movements of the "gouge" occurred at lower stresses. The models in Appendix D show that stresses needed to cause "gouge" intrusion are < 150 psi maximum.

Sample 25 was dark gray, very friable, and contained numerous platy-fragments that also were friable and had small areas with graphite luster. The northerly face of the block, where it broke from adjacent "gouge" during sampling, contained, over about 20% of the area, fine horizontal lineations. Close inspection of these lineations showed that they were not straight over distances longer than about 1/8 inch (0.2 cm.) and that they contained undulations and bends in the longitudinal direction. They did not have the appearance of striae generated by slip movement. This break surface had an essentially vertical dip and a strike of N35°E. The remainder of the block was highly fragmented and contained sporadic foliate surfaces that varied randomly in orientation and displayed graphite luster. These surfaces generally were 1/8 inch to 1/4 inch wide (0.2 to 0.5 cm.), but one zone where they were concentrated measured about 1/2 inch by one inch (1.2 by 2.5 cm.) In this zone pyrite crystals were seen protruding through the lustrous surface indicating pyrite crystallization subsequent to development of the lustrous surface.

Sample 26 was a "gouge" sample that was taken adjacent to and was essentially the same as Sample 25, except that it did not contain any single zone where the lustrous faces were concentrated. The small lustrous areas (1/8-1/4" or 0.2-0.5 cm. size) were randomly oriented and located sporadically throughout the sample. It appeared that these areas were faces coated by graphite or a graphite-like mineral. Hence, in spite of the differences observed in the rotation shear tests on Samples 25 and 26, no corresponding differences were observed in the two samples.

Thin sections of the "gouge" and adjacent phyllite were made and compared primarily to look for evidence of cataclasis. Thin sections G-4C through P-3 in Table C-8 were studied. Quartz and muscovite are two minerals that can preserve cataclastic textures. Both minerals are found in the soft gray "gouge". In most cases no cataclastic structure or texture was found associated with the individual grains of either mineral. For example, many quartz grains are shown in Photos A-32, A-33, A-34 and A-35, and one grain of muscovite is shown in Photo A-36, none of which show evidence of cataclasis.

On the other hand, the texture and angularity of some clusters of quartz grains, such as shown in Photos A-37 and A-38, suggest that shear has occurred at some time in the history of the rock material. In addition, some aggregates of quartz grains show abrupt changes in grain size, such as shown in Photo A-39, which may be a result of shear. However, the individual quartz grains were not found to display any preferred crystallographic orientation such as might be associated with cataclastic shear. Furthermore, samples of the phyllite, which have been subjected to regional metamorphism but not cataclasis, contain quartz grains which have textures similar to the quartz grains found in the soft gray "gouge", e.g., see Photo A-32.

Other typically cataclastic textural details such as augen structure, mortar structure, microbrecciation, microfaulting, recrystallization and neomineralization were not found in the soft gray "gouge". A few quartz grains of the soft gray "gouge" show undulatory extinction, a feature indicative of strain, but not necessarily strain due to cataclasis.

In general, the thin sections of the soft gray "gouge" displayed less evidence of microscopic foliation than was visible megascopically in hand specimens, probably because portions of the thin sections were plucked out while they were being polished. One of the better examples of foliation in the soft gray "gouge" observed in thin section is shown in Photo A-40. Examples of the foliation in the thin sections made from the samples of phyllite are shown in Photos A-37, A-41 and A-42. The foliation in the phyllite is well developed, usually uncontorted, and continuous along the length of the thin section.

### 3. Glacial Deposits

#### a. General Sequence

Trench B contains a greater number of strata representing individual glacial and interglacial periods than Trench A. All of the sequence in Trench A, where bedrock is shallower than in Trench B, is contained within the sequence of Trench B.

The sequence of identifiable surficial units of Trench B is given below beginning with the uppermost materials (see Figure 5). Trench A appears to contain Units 1, 2, 5 and possibly 9 (see Figure 4). Unit 3 may also be present but if it is, we have not been able to distinguish it from Unit 5.

Unit sequence consists of:

1. A Holocene soil zone averaging 18 inches (46 cm.) in wave-worked ablation till and outwash deposits.



2. A loose unsorted ablation till at the north end of the trench grading into sorted outwash sands and gravels at the south end which represent deposits derived from the wasting of the last ice sheet to cover Sears Island.
3. An olive fine-grained till located immediately over a glaciomarine deposit. This Unit is the basal till of the last readvance at the end of the Laurentide glaciation.
4. A glaciomarine deposit consisting of thinly laminated fine sands, silts and clayey silts.
5. A fine-grained lodgment till, olive (oxidized) near the top and grading downward to gray (unoxidized) near the bottom.
6. A partially sorted, gravelly fine sand and silty outwash or washed till.
7. An iron cemented, partially sorted "ferruginite" composed of gravelly sand cemented by limonite and hematite, hypothesized to represent weathering of an outwash or fluvial deposit during a warm interglacial period.
8. A gravelly silty sandy till unit, partially oxidized and occasionally sorted.
9. Older granular tills emplaced in bedrock crevices and unconformably overlain by younger tills.

b. Detailed Description of Each Surficial Unit

Units 1 and 2

The north end of both Trenches A and B have an apparent ablation till at the top of the surficial sequence. The material is a widely graded silty gravelly sand and contains many cobbles and boulders which are often found on ground surface. The Holocene soil zone is moderately well developed and averages 18 inches (46 cm.) thick. Color is reddish brown in the soil zone (except where poorly drained) and olive brown to olive in the C-horizon and parent till material. The ablation till averages 12 to 48 inches (30 to 122 cm.) thick and its surface has been reworked by waves during the period of falling sea level 13,500 to 12,200 years ago. Surface boulders are more concentrated on steeper portions of the island where the ground was more exposed to wave attack and some fine material was washed away. Sand grains are subangular to subrounded. Sorting is not usually evident but occasional rock pockets and pebble imbrication are found near the bottom of the unit. The deposit may be moderately dense but it is usually loose and friable and contains most of the root zone. The ablation till differs from what appears to be a lodgment till below it in being less dense, containing fewer fines, having a much higher permeability, and lacking the fissile structure of the lodgment till. Several clumps of dense lodgment-like till have been found in this unit that illustrate the contrast in properties between the two types of tills (see Photo B-25).

The ablation till grades into outwash near the south ends of both Trenches A and B (see Photos A-27 and B-24). The outwash is a stratified deposit, gently dipping or parallel to the underlying lodgment till or marine deposits (see Photo A-28). Individual strata are ½ to 3 inches (1 to 8 cm.) thick. Some strata are fairly well sorted sand whereas other strata are more widely graded gravelly sand (see Photo B-26 and Graphs C-14 and C-15).

The ablation till covers all of Sears Island except for the small areas where outwash, exposed bedrock or landslide surfaces occur. The distribution of the outwash is shown in Figure 6. The ablation till and outwash are interpreted to be synchronous in origin. The outwash is interpreted to have been deposited in water flowing out from the bottom edge of an ice mass melting on Sears Island. Since some hydraulic head of meltwater would have had to have been present to flow through and sort these materials below sea level, the ice may have been greater than 100 feet (30 m.) thick at this point, the maximum depth of ocean over the top of Sears Island at the time of deglaciation.

Borns (1967) mentions kames with 200 feet (60 m.) of relief in eastern Maine. A kame in Stockton Springs (Fig. 10) has greater than 200 feet (60 m.) of relief indicating that nearly vertical ice fronts of 200 feet (60 m.) and greater stood against the ocean.

It may also be possible that an ice mass persisted on Sears Island until relative sea level dropped below present elevation 115 ft. McDonald (1968) mentions stagnant ice persisting for 145 years in the Champlain Sea. If rebound at Sears Island was occurring at 4 inches (0.1 m.) per year, 164 feet (50 m.) of sea level drop would have taken 500 years. However, if sea level was dropping at 20 inches (0.5 m.) per year just after deglaciation as some evidence suggests, only 100 years would be required to uncover one half of Sears Island. Conceivably, an isolated ice mass could have persisted this long, thus allowing the outwash to be deposited above sea level.

There are several characteristics of the outwash material that differentiate it from an elevated beach deposit. The change from ablation till to outwash occurs very gradually and the sorting begins near the bottom of the ablation deposit, then works up to the top of the deposit with distance from north to south (See Photo B-24). Drake (1971) mentions that he found ablation till grading into kame gravel with no discernible break. On the east wall of Trench B (Figure 5), the sorted bedding dips 20° NW initially, gradually changes to flat lying, then to a gentle SE dip (Photos B-24, 25, 26). Clumps of lodgment-type till occur in several places within the outwash, which would be unlikely in an elevated beach deposit. The grain size curves in Graphs C-14 and C-15 are typical of outwash and do not compare with the grain size curves of present beach deposits at the north end of Sears Island, which are shown in Graphs C-16, 17. Table C-10 gives a detailed description of the outwash of Trench B and of the present day beach deposits. A final consideration is the topographic configuration of the outwash deposit that occurs over Trenches A and B. Elevated beach deposits are not common in this area, but where they are found, they normally

form a narrow terrace at equal elevation in a sheltered re-entrant. The outwash over Trenches A and B is part of a contiguous deposit that runs diagonally across the slope from elevation 110 to 180 feet on convex topography and in a very exposed position (See Figure 6). One would expect a much coarser "shingle" beach similar to that presently found on the southeast shore of the island. All evidence points to the conclusion that the outwash was deposited at the edge of an irregular ice mass on Sears Island, probably in meltwater flowing to the southeast under hydraulic head from the bottom of the ice.

The age of this unit is probably between 13,500 and 12,500 years B.P., the time of last ice wasting over Sears Island as defined by regional radiocarbon dating.

### Unit 3

This unit is the youngest lodgment-type till found on the Island. It is a widely graded olive gravelly sandy silt with a subangular blocky structure that is made apparent by a pattern of manganese oxide staining on fissures (See Photo B-23). Two fissure patterns are prominent. There is a major set with nearly flat lying or gently SE dipping planes and a minor set with a spacing of 2 to 4 inches (5-10 cm.) dipping near vertically and striking NE to ENE. The fissure pattern appears to be directly related to the fabric created during deposition. This till is similar to Unit 5, the main Laurentide lodgment till, except for the following:

- 1) Unit 3 is apparently quite limited in thickness and areal extent (it has been clearly identified only in the vicinity of Trench B and on the southern edge of the Island).
- 2) Tests of GEI Sample BF103-I showed slightly less sand and slightly more silt (~5%) than average for the main lodgment till sample. (See Graph C-11 and Table C-2)
- 3) Boulders are rare in Unit 3 (but cobbles are common).
- 4) The average dry unit weight for the Unit 3 samples was 123 pcf (1.97 gm./cm.<sup>3</sup>) versus 134 pcf (2.15 gm./cm.<sup>3</sup>) for the gray tills in Trenches A and B (See Table C-2).

The density difference between this upper lodgment till and the main Laurentide till indicates that a much thinner ice sheet deposited the upper till during a late readvance. Toward the south end of Unit 3, there are inclusions of the underlying laminated marine deposit that were incorporated into the till during the readvance.

An interesting feature of this olive till is the mottling pattern which has not been found more than 10 feet (3 m.) below ground surface. The relatively low permeability of the lodgment till and the gentle topographic slopes create a seasonal perched water table with the typical pattern of gray and strong brown mottles. Although most of the

mottling conforms to the till fabric, some of it looks similar to periglacial frost structures – ice fissures – discussed by Macar (1969) (see Photo B-23).

Based on regional considerations, the age of this unit is 15,600 to 12,800 years, the time between the earliest possible end of underlying marine unit deposition and the time of possible last advance.

#### Unit 4

This waterlaid unit is found in Trench B but not in Trench A. Analysis of GEI samples F103-II and F104-III show these deposits to be olive thinly-laminated fine sands, silts, and clayey silts (see Table C-7), with much lower dry unit weight – 105 pcf (1.68 gm./cm.<sup>3</sup>) – than the lodgment tills. The Plasticity Indexes (see Graph C-19) and water contents (see Table C-5) are higher than the tills by 14 and 20% respectively. The individual beds are poorly graded (which partly accounts for the lower unit weight) and the grain size curves (see Graph C-12) have the same shape as some of the upper outwash strata at the south end of Trench B (see Graphs C-14, 15). The unit has an overall blocky structure created by a joint pattern similar to the overlying till; however, the joints are more regular and closely spaced in the marine unit. Photos B-15 through 19 show the structure and stratification typical of the unit.

The structure of the unit has been deformed by several ice-related forces. Local portions of the deposit have contorted bedding as a result of clumps of till and pebbles dropped into the deposit from floating melting ice (see Photo B-20). An apparent till mudflow into the south end of Trench B disturbed the marine deposits during the time of their deposition (see Figure 5 and Photo B-13). The most potent deformation force, however, was ice shove and base shear from the readvance that deposited the till over this unit. An overall distortion of the unit is apparent, as is localized underthrust and overthrust drag folding and faulting (see Photos B-20, 21). Part of the apparent distortion is due to the fact that the westerly edge of the unit coincided with the edge of the excavation at the north end of the trench. However, a careful study of the exposures on both east and west walls suggests that the unit was distorted as a whole by the ice moving some segments of the unit around separately. One segment was pushed down and forward under a southerly portion of the unit (see Figure 5 under station B-15).

The marine deposit of Trench B has not been found to be connected to marine deposits at lower elevations along the south, east and north edges of the island. The lower marine deposits may represent a different time of deposition, and certainly represent different conditions of deposition. The lower marine deposits have thicker individual strata--4 inches versus 0.4 inches average (10 cm. versus 10 mm.) in the trench – and thick soft silty clay units.

This unit has been called marine in origin rather than lacustrine because the bulk of the evidence suggests that Sears Island was below sea level at the time of deposition. Dropstones and till clumps found in the unit call for floating ice in the area during formation and it is known that during deglaciation about 13,000 B.P., relative sea

level was almost 100 feet (30 m.) above Sears Island. The stratification does not have true varving characteristics as one might expect in a true lake deposit. Crosbie-Macomber Paleontological Laboratory, Inc., of Metairie, Louisiana, had called the deposit "non-marine" since it did not find any megafossils or microfossils in GEI sample B-F103-II; however, it did find relatively fresh pollen (unidentified as to type). The absence of fossils does not rule out a marine origin. Numerous references (e.g. Caldwell, 1959; Borns and Hagar, 1965; and McDonald, 1968) have noted the scarcity of fossils in glacio-marine deposits. The presence of pollen is also not surprising since Borns, Davis and Sanger (1974) claim tundra vegetation occupied the eastern coastal region of Maine about 13,500 B.P. when minor readvances were still occurring during overall ice retreat.

The age of this unit is probably 16,500 to 12,800 years. A number of calcium carbonate accretions found in this unit were radiocarbon dated to  $15,595 \pm 400$  B.P. As discussed in Section III.1., this date correlates with the end of the Erie Interstade; however, no other evidence of ice retreat at the coast of Maine at this time is known.

#### Unit 5

The main lodgment till of the Laurentide Advance is composed of both olive (oxidized) upper portions and gray (unoxidized), usually lower portions. This is the major unit of Trench A, much of Trench B, and most of the Island.

Grain size curves and index properties on samples from test pits and borings in the unit on other parts of the Island are remarkably similar to the results obtained in Trenches A and B. The till is a medium dense to very dense, widely-graded gravelly sandy silt with cobbles and boulders scattered throughout. Graph C-11 illustrates the typical grain size curves of this unit (Sample F103-I-1 is from Unit 3). Table C-7 discusses the results of Tests on sample B-F107-IV from Trench B. The average dry density of the gray tills sampled is 134 pcf (2.15 gm./cm.<sup>3</sup>) and that of the olive tills is 131 pcf (2.10 gm./cm.<sup>3</sup>) (see Tables C-2 and C-4). Specific gravity averaged 2.72 (Table C-1) for the samples tested. Sand grains are subangular to subrounded. Plasticity Index averages 10 (Graph C-18). Water contents average 9 to 10% (see Tables C-2 and C-3). Percent saturation is generally high even above the true water table since capillary rise is effective for 10 to 20 feet (3 to 6 m.) in this material. The high density of the deposit and wide range in grain size result in a high angle of internal friction and cohesion strength. Rotation shear tests on undisturbed samples from Trench A by GEI found 42° and 10,000 psf (4.88 kg./cm.<sup>2</sup>) respectively.

At the south end of Trench B, the unit is softer than average and contains inclusions of plastic silts. It appears that a small silt deposit in the middle of Trench B was incorporated into the till at the beginning of the advance.

The majority of the boulders and cobbles mapped in the trench walls and in test pits around the Island were granitic in origin and probably derived from the Mt. Waldo Pluton 4 miles (6 km.) to the north. Most Maine investigators (e.g., Borns; 1975) have found that the majority of glacial till materials are deposited within 2 to 5 miles

(3 to 8 km.) from the source. Gross and Moran (1971) concluded that 50% of the Titusville Till (Pennsylvania) was derived within 20 miles (33 km.) of the site of deposition. Some till constituents on Sears Island did travel a great distance, however. Brachiopod fossils from the Moosehead Lake area 95 miles (160 km.) to the NNW are found in boulders in the till on Sears Island. Thin sections made from samples of Unit 5 till in Trench A (Table C-8) gave the approximate average modal composition: 35% quartzite, 20% quartz, 25% schist, 5-10% phyllite and small amounts of plagioclase, orthoclase and granite. The phyllite content appears to increase slightly with depth as one nears the phyllite bedrock surface. This corresponds with Gross and Moran's (1971) general finding on the tills of the Allegheny Plateau. Analysis of mineralogical content of the fraction of sieve samples less than 0.074 mm. in size was performed by both Prof. Gene Simmons and Prof. Robert Martin of MIT. The results were quite uniform among the samples and showed about 50% quartz, 25% feldspars, and the remainder were mafic silicates, opaques (trace amounts of magnetite and pyrite), and clays. The grains smaller than 2  $\mu$  were primarily chlorite and muscovite.

The fabric of the till seems in general to be related to the pattern of deposition and also base shear during later ice overriding. Pebble imbrication is particularly evident at the north end of Trench B. Although no statistical studies of pebble orientation were done, observations during careful mapping showed a predominant NNE orientation with the long axis approximately parallel to bedrock slope. Another fabric element found consisted of very thin silty partings similar to the "bed limits" of Virkkala mentioned in Moran (1971), which represent shear planes within the till that roughly parallel the bedrock surface. The joints in this till are not so closely spaced as in Units 3 and 4. However, joints are locally concentrated and usually stained with manganese oxide and limonite. The dominant sets consist of: a) a set more or less planar and parallel to bedrock slope; b) occasional SE dipping, downward curving sets; c) NW steeply dipping or vertical sets striking transverse to the direction of glacial movement. Where joints occur, they are normally spaced several inches apart. There is a complex joint pattern over the middle of Trench B that may be related to the suspected bedrock arching during deglaciation.

An interesting phenomenon of this Laurentide lodgment till is the pattern of olive and gray colors (see Photos A-18, A-25, 26, 27). The olive till usually has a higher position in the stratigraphic column, then a zone of interfingering and intermediate color tones occurs before changing to all gray at the bottom of the unit. Normally the color patterns conform to the till fabric. We conclude that the olive till was a gray till that has been stained by the oxidation of biotite. Prof. Gene Simmons of MIT did extensive work to determine whether the olive (also called brown or olive brown as on Figure 4) till was a distinct till from the gray till. Heavy metal separation, X-ray diffraction and microscopic study showed: a) the major, minor, and trace minerals in the two tills (olive versus gray) are quite similar and probably identical, b) the chief difference between the two tills is the color and it is due to staining by iron oxides, c) both tills contain biotite but the biotite in the olive till has a more weathered appearance than the biotite in the gray till, d) the biotite in the olive till is spatially associated with the red to brown staining.

Two other distinct types of oxidation occur in this unit in addition to that just described and they should not be confused. One type is composed of bands of heavy, closely spaced, very thin limonite lines; the other type is the "rusty crack" zone leading up out of the "gouge" intrusion in Trench A. Photos A-21, 22 and 23, and B-14 show bands of limonite staining. The reddish brown coloration on otherwise gray till is due to closely spaced, very thin (~0.1 mm.) wavy planes of iron oxide, assumed to be chiefly limonite. The spacing of the individual lines is arithmetic. Except for this feature they appear similar to Lisegang ring formation.

A third type of oxidation in the till is the limonite staining on the "rusty crack" surface leading upward from the gouge intrusions in Trench A at Stations F-1, F-2, F-3 and near Pt. 11 (see Figure 4). Section V.4.b of this report describes the till deformation in this till unit in Trench A. At F-2 the original west wall of Trench A, the "crack" becomes limonite-stained about 20 inches (0.5 m.) above the "gouge" intrusion (see Photo A-6); at F-1 in Trench A it began immediately above the "gouge" (Photos A-2, 3); at F-3 in Trench A the limonite staining extends right down into the "gouge" (Photo A-10); at F-4 two faint, steeply rising "cracks" are not limonite-stained (Photo A-11, 16). At F-1, F-2 and F-3 there is a sense of overthrusting (dragged till fabric) and shear up to about one foot (0.3 m.) above the "gouge" intrusion (see Photo A-3). Above this level the sense of shear disappears and 6 feet (1.8 m.) above the "gouge" evidence of "cracking" – "rusty" or otherwise – disappears. In the upper portion of the "cracks", the limonite staining passes across the face of cobbles, evidence that large displacements have not occurred (Photos A-18, 19, 20). Note that in Photo A-21, the "rusty" staining is wavy. The limonite band staining and "rusty" staining on the till cracks both seem to have formed from iron oxide contained in ground water moving upward through the till from the bedrock. The till is less permeable than the bedrock here, thereby creating artesian conditions, also found at other locations on the island. When the chemical conditions are suitable, the iron oxide comes out of solution. In the case of the dense, undisturbed till, a band of limonite staining occurs, whereas in the "cracks" above the "gouge" intrusion where the till is slightly disturbed, the staining occurred as one very thin planar limonite deposit.

Several studies were done to determine if shear had taken place along the upper portions of the "rusty cracks" in Trench A. Figure 9 shows the location of GEI samples on the original east wall (Figure 7) of Trench A, above F-1. A detailed study of water contents across the "rusty" zone (Table C-3) did not show any increases near the crack. If shear had taken place, dilation of the till near the crack should lead to higher water contents. Thin sections in several planes taken from undisturbed samples across the rusty zone did not show any sign of fabric parallel to the rusty zone that would suggest shear. Rotation shear tests on the till (Table C-9) were not able to produce well defined slickensides that were detectable by either optical or scanning electron microscope, implying that shear may have taken place in the field without producing slickensides. Although the absence of slickensides does not necessarily mean absence of shear, the lack of microscopic fabric orientation or water content

anomalies in the upper portions of the "cracks" suggests that either tension cracking occurred or the shear strain was so small that no reorientation took place.

The age of this lodgment till is estimated to be 22,000 to 16,500 years based on regional considerations.

## Unit 6

Immediately below the main Laurentide lodgment till in the lower elevations of Trench B, there is a limonite-stained crudely stratified material composed of partially cemented sand and gravelly sand (see Figure 5 and Photo B-12). The sand strata are somewhat poorly graded, loose to medium dense, medium sand. The feldspar and quartz grains are subangular. The top part of the deposit has been carried up into and mixed with the bottom of Unit 5. Where Unit 6 is intact, the strata dip gently SE. This unit is much more pervious than Unit 5 and water seepage occurred here during the Trench B excavation. At the point of water seepage, a green slime (iron bacteria?) developed.

Correlation of this unit with other similar deposits on Sears Island is not conclusive. The northeasterly extension of the bedrock trough containing Trenches A and B contains gravelly sands (split spoon samples from Boring 106); however, it is not certain whether this is correlated with Unit 6 or with Unit 8 – the older till/outwash below the "ferruginite" of Trench B. An ambiguity rests with the gravelly sands sampled in Boring 119, although the stratigraphic sequence of Boring 13 suggests the gravelly sands there are probably correlated with Unit 6.

The age of this outwash is uncertain, but it is clear that the outwash is not nearly as thoroughly cemented as the immediately underlying ferruginite.

## Unit 7

One of the most interesting units of Trench B is the "ferruginite" bed that overlies the rock and fills crevices at the north end of Trench B and overlies till to the south. The ferruginite is a sand and gravelly sand cemented with iron oxides. A rock cut (identified as B-CUT on Figure 9) was blasted about 8 feet deep at the north end of Trench B. The ferruginite, called a "limonitic breccia" by Prof. Gene Simmons of MIT, fills rock crevices at least to the depth of the cut. Since yellow (limonitic?) and red (hematitic?) veins cross-cut each other, more than one episode of deposition must have occurred in the rock crevices. These crevices generally dip steeply to the southeast except near the top of the cut where the near-vertical phyllitic bedding and cleavage is rolled over to the southeast and low angle SE dipping crevices were opened by glacial ice shear (see Photo B-7).

Prof. Gene Simmons and Dorothy Richter of MIT examined specimen TR-B1 (see Figure 9) of the ferruginite chipped off the top of the bedrock surface at the north end of Trench B. They described the sample as a layered clastic rock with a markedly brownish red (hematitic?) matrix. Clasts are angular to subrounded in shape and



consist of quartz, feldspar, limonite, phyllite, schist, muscovite and epidote. The grains are rather loosely cemented and the sample is porous. The clasts are rarely in contact with each other, usually separated by a small amount of iron oxide matrix. There is no preferred orientation of the clasts and only rough grain size sorting. The matrix, which represented 20% of the volume of the sample, is cryptocrystalline and varies in color and transparency. Most of the matrix is grainy but in a few places it is banded around grains. X-ray maps of the matrix made with the scanning electron microscope (SEM) indicate the iron is uniformly distributed in the matrix and the color variations are probably due to variations in water content. There is no evidence of either a fault or volcanic origin for the sample.

As shown in Figure 5, at the northwesterly end of Trench B, the ferruginite unit lies over the bedrock surface for some distance then leaves the bedrock surface and extends about halfway across the trough of Trench B in a well defined unit about 1 foot (0.3 m.) thick on top of an older till/outwash (see Photos B-10, B-12). It is not clear whether the unit had originally spanned Trench B and was then disrupted by the main Laurentide advance or whether the iron oxide matrix never developed in the south end of Trench B. This ferruginite is not found in Trench A nor has it been found in any drill-hole samples (although it could easily be missed in drill-holes). However, in two testpits on the southeast corner of the Island, a porous cemented iron pan was found on top of the bedrock surface. This porous pan readily conducted ground water but the matrix did not have the reddish hue present in Trench B.

The laminations and partial grain size sorting suggest an original sedimentary origin for the clasts. The iron oxide of the matrix could have leached out of the phyllite or developed from weathering of iron-rich clays. No paleosol structure was observed, nor has any datable carbonaceous material been found in the unit.

On the basis of present evidence we infer that this unit developed during an extended warm climatic period. This unit must have formed prior to the main Laurentide advance since cobble and gravel size angular fragments of the ferruginite are contained in Units 5 and 6 above, and no upper stratified sand and gravel material is so oxidized or cemented in either saturated or unsaturated states. No post-Laurentide cementation of this type is known to have occurred in Maine. Caldwell (1975) has stated that he sees a similarity between the ferruginite and an oxidized soil horizon at New Sharon, Maine (Caldwell, 1959), which underlies wood fragments dated at greater than 52,000 years. Ruhe (1965) states that pre-Wisconsinan paleosols have stronger chromas and redder hues in the B horizons than at present. Paleosols and oxidation in Salmon Springs till (older than 38,000 B.P. but younger than Sangamon according to Crandell, 1965) observed by Rand and Gerber on the Olympic Peninsula in Washington did not appear to have developed this degree of oxidation. Conley and Drummond (1965) have suggested that "weathered, rounded K-feldspar fragments, ferruginous concentrations and iron cemented sands" in the alluvial terraces of Saluda, North Carolina, are early Pleistocene or even Pliocene. If an extended warm climatic period is required for the red iron oxide matrix (hematitic?) development, then a review of climatic fluctuations in the past 130,000 years suggests that the

ferruginite developed in Earliest Wisconsinan or Sangamon. This age is consistent both stratigraphically and with the radiocarbon dates from the oxidized stratum found at New Sharon, Maine.

#### Unit 8

A gravelly silty sand, occasionally oxidized and lightly cemented, lies below the "ferruginite" in Trench B. In some portions of the Trench it appears to exhibit some sorting and crude stratification. It is occasionally referred to as a till/outwash in this report because the same stratigraphic unit has characteristics of both. Many blocks of phyllite drift are enclosed in the bottom of this deposit, particularly at the south end of Trench B. Just over the bedrock surface in the bottom of Trench B, there is a sequence of fine sands and silts (e.g., see Photo B-5).

GEI samples B-F110-V and B-F114-VIII were taken from this unit (see Figure 9 and Photos B-9, 10, 11). Table C-5, Graphs C-12 and C-18 contain information on the physical properties of this material. The material has a lower dry unit weight than the main Laurentide lodgment till, generally fewer fines (although some silty strata are present), and a lower Plasticity Index. The mineralogy as determined by GEI and Prof. Gene Simmons of MIT is similar to the upper tills. The "cracks" in the unit are discussed in section V.4.b. of this report.

Unit 8 does not occur in Trench A but is inferred to extend for some distance northeasterly along the bedrock trough from Trench B. It is uncertain whether Unit 8 occurs in other locations on the Island such as on the steep southeasterly side.

#### Unit 9

In several places in both Trenches A and B, granular tills are found in bedrock crevices to depths of at least 10 feet (3 m.). Glacial ice shove and base shear have opened up crevices both parallel to and across foliation. (Foliation generally trends approximately perpendicular to direction of ice movement.) Photo B-8 shows a felsic dike faulted by ice shove. The shear plane is filled with till. On the west wall of Trench B, adjacent to Station B-8, granular till fills bedrock crevices dipping steeply to the southeast. This till is truncated by the outwash/ till of Unit 8 above. These till crevice fillings, therefore, are the oldest tills found. They could be early tills of the advance that deposited Unit 8 or they could be from an earlier glacial period.

### 4. Faulting

#### a. Bedrock Faults

A fault zone in the bedrock underlies the trough of the bedrock depression, and is interpreted to trend between Trenches A and B on a strike of about N34°E. This zone is also interpreted to extend to Boring B-106, about 1400' (425 m.) to the northeast of Trench B (Figures 2 and 6). In Trench A (Figure 4, Rock Cut), three N34°E fault planes are exposed. The southern fault plane in the rock cut dips about 80° to the northwest

(Photo A-15). The northern two fault planes in the rock cut define a zone about 3½' (1 m.) thick which dips 66° to the southeast; the "gouge" zone lies on the southernmost of this pair of fault planes (Photos A-12, 13). In Trench B, where the bedrock exposure is of limited extent, a single fault plane has been identified to date, with a dip of about 60° to the southeast (Figure 5). Phyllite in the fault zone of both trenches is characterized by deformed foliation, pyrite dissemination and veining, and quartz veining; these conditions also obtain below 152' (46 m.) depth in Boring B-106.

The sense of displacement of bedrock faulting appears originally to have been normal, with a slight strike-slip, right-lateral aspect. The attitude of quartz lenses in the southeast-dipping fault zone in Trench A (Photos A-12, 13) and steps on mullion grooves on a fault in Trench B (Figure 5, Rock Cut-East Wall diagram) suggest that the southeast block originally moved down relative to the northwest block. Southwest-plunging mullion grooves on this Trench B fault surface, slickensides on a fault surface in Boring B-106 (assuming that fault dips to the southeast) and striations on a bedrock surface at Nail F-4 in Trench A (Photo A-11) all suggest steep right-lateral displacement of the southeast block down toward the south. No evidence has been observed with which to estimate the total offset on this fault zone.

The age of bedrock faulting has not been determined, but it is interpreted to be ancient. Although the faults have offset the felsic dike material (Photos A-12, 13) which has a minimum age of 283 million years (Sample TR-B3, Trench B; Figure 9), the intimate association of thin "strung-out" quartz veinlets with all fault planes suggests that faulting originally occurred under conditions of deep burial. The "gouge" at Nail F-3, Trench A, produced a minimum age (potassium-argon) of  $270 \pm 10$  million years (Sample A-F3; Figures 7, 8), indicating a pre-Mesozoic age of last crystallization of the phyllite from which the "gouge" was formed. The discrete fault planes of both trenches do not differentially offset the till/bedrock contact; where the "gouge" intrudes till in Trench A no consistent sense of relative vertical displacement of adjacent bedrock masses can be observed (Photos A-1 through A-11).

#### b. Deformation of Glacial Till

The till/bedrock contact in both trenches has locally, but not everywhere, been deformed along the portion of the bedrock trough that is underlain by the weathered bedrock fault zone (Figure 3). In Trench A, the deformation is characterized by the local intrusion of a seam of soft phyllite "gouge" material upward into the overlying till. In Trench B, the deformation occurs as a discontinuous small-displacement rupture of the till/bedrock contact, associated with a gentle arching of that contact. The northeasterly average trend of the "gouge" intrusion in Trench A appears to project to the rupture and arching deformation of Trench B, along the N34°E strike of the bedrock fault planes of Trench A.

##### Trench A

The nature of "gouge" deformation of the 22,000-16,500 year-old (Laurentide) lodgment till in Trench A is described by several profiles on Figure 4, and by Photos A-1, 2, 6, 7, 8, 9, 10 and 11. In all cases, "gouge" appears to have been squeezed up

into the till from the southeast. The upward squeezing of "gouge" at Point 11 (Figure 4; Photos A-7, 8) appears to have dragged a fine-grained sediment seam upward on the hanging wall surface of the "gouge", and to have pinched the seam off against the north underside of a large quartz drift boulder contained in the till. "Gouge" at Point 11 also has been squeezed horizontally to the southeast along the till/bedrock interface, and no drag folds or other deformational structures exist to suggest that the southeast bedrock block itself moved upward relative to the northwest block.

The "gouge" zone in the rock cut in Trench A locally ranges from about 2" (5 cm.) to as much as 1' (30 cm.) in thickness, but averages about 3-4" (8-10 cm.) in thickness at the point where it was intruded from the bedrock into the till. The "gouge" was intruded upward into the till above the irregular bedrock surface by as much as about 6" (15 cm.). The bedrock surface does not show glacial scouring in the trough of the bedrock depression, and is sufficiently weathered and irregular to preclude a conclusion that the bedrock itself was actually thrust as a block upward from the southeast.

Viewed from a distance along the original east wall (now removed) of Trench A (Photos A-4, 5), there was no noticeable elevation of the till/bedrock contact at the south of the "gouge" intrusion relative to that at the north of the "gouge". Due to the characteristic irregularity of the bedrock surface throughout Trench A, the southeast bedrock block appears superficially to be elevated slightly at Nails F-1, F-2 and F-3, to be slightly depressed at Point 11, and to be markedly depressed at Nail F-4. Sub-horizontal, fine-grained sediment fillings at Point 11 and F-3 (Photos A-7, 8 and A-9) do not show measurable vertical displacement of the southeast bedrock block relative to the northwest block.

In most cases thin, locally rusty discontinuous cracks rise from the "gouge" intrusion and trend northwesterly at moderate angles up into the overlying till, to die out within about 6' (2 m.) above the bedrock surface. There is evidence of an overthrust sense of displacement of the till (dragged bedding) immediately above the intrusion at some, but not all, exposures (Photos A-2, 3). These cracks always tend to flatten dip as they rise to the northwest. Individual cracks (the most prominent of which occurred at Nail F-1 (Photos A-1, 2, 3, 18, 19, 20, 21) have not been found to offset contacts between gray and brown tills, nor to continue laterally on strike for more than about 25' (8 m.). The cracking of the till is localized and delicate, and shows none of the extreme deformation that would have been produced had the "gouge" been created by mechanical grinding between the southeast and northwest bedrock blocks subsequent to till deposition. More details on the physical characteristics of these "cracks" are given in Section IV.3.b under the discussion of Unit 5, the main Laurentide lodgment till.

The profile of the west wall of the rock cut (Figure 4) shows first, that the well-defined bedrock faults at the north and south edges of the exposed bedrock fault zone do not offset the overlying till (see also Photos A-1, 4, 5, 15) and second, that low-angle shears in the bedrock between these faults consistently displace rock in the

central part of the zone outward and upward toward the surface, in a manner suggestive of simple lateral stress relief. Where these shears approached the "gouge" zone on the east wall of the rock cut, the "gouge" was deformed by having been squeezed upward. On the west wall, a low-angle overthrust shear successively offset segments of a quartz mass (Photos A-13, 14) toward the "gouge" zone through a total lateral displacement of about 4" (10 cm.).

## Trench B

The granular till immediately overlying bedrock in the trough of the bedrock depression in Trench B may be greater than 52,000 years old if the ferruginite is Sangamon in age. The nature of deformation of the till/bedrock contact in this trough is laterally variable (Figures 3 and 5), and ranges from a single 1" (3 cm.) displacement, reverse fault rupture on the east wall (Photos B-1, 2); through a 1" (3 cm.) monoclinical fold on the original west wall (Photos B-5, 6) of the trench, about 10' (3 m.) to the S34°W of the monoclinical fold. "Gouge" material does not intrude the till in Trench B, but is seen to have developed in the weathered phyllite bedrock within a foot or two (30-60 cm.) below the till/bedrock contact, and to continue downward to a depth of at least 6' (2 m.) as zones which dip moderately steeply to the southeast.

Several other zones of "gouge" which are seen in the Trench B bedrock in the general vicinity of the till/bedrock rupture do not rise to intrude the till. The bedrock surface in this area, unlike that in Trench A, forms a broad "hump" or arch just to the south of the single till/bedrock rupture, with an amplitude of about 1' (30 cm.) and a wave length of about 15' (5 m.). On the original west wall of the trench, a very low-angle, north-dipping micro-fault offset the till/bedrock contact near the south end of the bedrock "hump", at a point about 8' (2.4 m.) to the south of the 1-inch monoclinical fold (Figure 5, Rock Cut - Original West Wall insert).

Apparent, but not always distinctive, cracks rise from both the reverse rupture on the east wall and the monoclinical fold on the original west wall of Trench B, and trend for about 1-3' (30-90 cm.) at a moderate angle upward to the northwest to die out or be lost in laminated sediments which dip parallel to the cracks. On the final west wall of the trench (Photos B-4, 5) no discernible crack is associated with the zone of crumpled till above the undeformed bedrock surface. The lower granular till in Trench B is so universally streaked by southeast-dipping rusty staining and thin iron cemented (hematitic?) layers that it is not possible to discriminate between streaking due to oxidation on a deformational crack and that due to post-depositional subaerial weathering oxidation of the enclosing glacial sediments.

## VI. Geologic Interpretations of Deformational Features

### 1. Bedrock Faulting

The structure and distribution of quartz veinlets and lens-shaped masses within the bedrock fault zone of Trench A, combined with the configuration of steps on mullion grooves on a fault plane in Trench B, all suggest that the bedrock faults now exposed near ground surface in the trough of

the bedrock depression originated under conditions of deep burial in a normal (extensional) fault environment. Striations and grooved surfaces also suggest that the faulting originally had a minor component of right-lateral strike-slip displacement. Radiometric dating of "gouge" in Trench A indicates that the phyllite from which the "gouge" formed was last crystallized at least 270 million years ago. There is no evidence of renewed movement during the past more-than 52,000 years on the hard, planar surfaces identified as fault planes in Trenches A and B. No meaningful measure of relative post-glacial displacement can be attributed to the fault plane on which the "gouge" lies in Trench A: at close intervals the southeastern bedrock block is variously depressed, elevated or even with the northwestern block.

The plastic phyllite "gouge" in Trench A is the youngest geological material in the bedrock of the fault zone, and intrudes glacial till interpreted to be 22,000-16,500 years old. The deformation of the till by "gouge" appears to have a moderately-steep reverse fault sense of displacement, opposite to that interpreted for the original bedrock faulting. The "gouge" zone is not continuous laterally on strike across an exposed area of about 90' (28 m.) in Trench A (Figure 3), and is seen in the eastern part of that trench to pinch out and locally to change strike direction. "Gouge" is seen in several places, including in isolated phyllite drift blocks in till, to have formed by passive weathering disintegration of phyllite. The lack of chaotic deformation in till overlying the "gouge" zone in Trench A indicates that the "gouge" was not formed by mechanical grinding of fault planes subsequent to the deposition of the till.

## 2. Deformation of the Till

Characteristic deformations of the till that overlies the "gouge" intrusion in Trench A and the rupture/monocline structure in Trench B include locally-rusty crack development and drag folding. In Trench A, there is also a change in texture of the till from the northwest side of the rusty crack to the southeast side.

Crack development commonly takes the form of a single fairly planar parting, more or less oxidized, which rises at a moderate angle to the northwest from the footwall of the "gouge" intrusion in Trench A, and from the till/bedrock rupture in Trench B. The crack tends to flatten progressively as it rises to the northwest, and may branch locally into other, still flatter cracks before dying out within about 6' (2 m.) above the bedrock surface. In Trench B, the crack becomes lost within a few feet above the rupture/monocline in parallel-dipping laminated glacial sediments.

Drag-fold deformation (Photos A-2, 3), sometimes discernible only as vague crumple folding (Photo B-4), occurs locally in the till immediately underlying the crack rising northwesterly from the point of till/bedrock deformation. No drag folding has been observed in the till that overlies the crack and no throughgoing contacts in the till have been observed to be displaced across the crack. An apparent textural change occurs in the fine-grained lodgment till of Trench A at the boundary defined by the locally-rusty crack; the till to the northwest of the crack shows a hackly excavated surface, while the till to the southeast of the crack shows a smooth excavated surface (Photos A-1, 2, 18). These features of drag folding and textural deformation, associated only with till lying to the northwest of the locally-rusty crack, suggest that this till was at some time subject to a stress regime not experienced by the till lying to the southeast of the crack. The style

of deformation strongly suggests that the till to the northwest was uniquely stressed by a loading from above and to the northwest of the crack in Trench A.

In Trench B, the greater-than 52,000 year-old granular till which overlies the ruptured bedrock surface is too coarse-grained throughout to exhibit textural changes across the short crack boundary above the rupture. The till/bedrock rupture and the monoclinical fold of the original west wall are, however, associated with, respectively, a prominent and a moderate "hump" or arching of the bedrock surface (Figure 5; Photo B-1), and to the northwest of the till/bedrock rupture on the east wall the bedrock has been markedly depressed by as much as 2½' (75 cm.). The glacio-marine sand-silt unit seen higher in the stratigraphic column (Figure 5) also exhibits a structural bowing down from its originally horizontal depositional configuration. The styles of deformation in Trench B suggest that the area to the northwest of the till/bedrock rupture was stressed by a loading from above and to the northwest of the rupture zone.

### 3. Glacial Origin of Till/Bedrock Deformations

The preponderance of evidence indicates a glaciotectonic or glacial-related force rather than one of crustal tectonic origin for the generation of the "gouge" intrusion in Trench A and created the small reverse fault rupture and fold deformation in Trench B.

#### a. Features Indicative of Non-Tectonic Origin

Although the N34°E bedrock fault zone may be interpreted to extend for several thousand feet (500 or more meters) in the vicinity of the site, with a fault zone width of tens of feet (10 meters or more), the till/bedrock deformation which is spatially associated with the bed-rock fault zone on Trench B amounts to only about 1" (3 cm.) of displacement. No consistent sense of displacement of the bedrock adjacent to the "gouge" intrusion in Trench A can be defined. The very small and localized deformation of the till/bedrock contact does not justify a concept of tectonic activity on the significantly larger bedrock fault structure.

The deformation of the till/bedrock contact is not laterally continuous, as would be expected from tectonic movement on the bedrock fault zone. Deformation in Trench B ranges from a ruptured till/bedrock contact on the east wall to no deformation of the till/bedrock contact on the final west wall. The "gouge" zone in Trench A is not continuous laterally across 40' (12 m.) of exposed bedrock surface in the east part of the trench.

The sense of displacement of the till/bedrock contact and the zone of "gouge" intrusion is that of reverse faulting, with compression directed from southeast to northwest. The eastern part of North America is generally held to have been the trailing edge of the continental plate for as much as 150 million years, and as such to have been subject to extensional, rather than compressional, crustal forces. The only sources of northwest-southeast compression occurred upon the retreat of the last continental ice sheet, some 13,500 to 12,800 years ago. This compression resulted from one or a combination of the following: 1) lateral stress relief of harder bedrock into soft bedrock in the trough of the fault zone, 2) horizontal southeasterly directed shear stresses on the bedrock to the

northwest of the fault zone created by a late glacial lobe advance, 3) wave-form land rebound moving northwesterly with the ice retreat. These forces are discussed in Appendices D and E.

The deformation of the till/bedrock contact occurs as a single small rupture or fold which has affected glacial deposits of 22,000-16,500 years age in Trench A, and deposits that may be greater than 52,000 years in Trench B. There has been a single very small and laterally-discontinuous deformational event in the last 22,000 years, but no other movement of this type has apparently occurred in what may be as much as 52,000 years since the older till has the same magnitude of movement, or less. This condition is not suggestive of a geological environment subject to continuing compressional tectonic forces. Radiometric dating of "gouge" indicates that prior to its intrusion as "gouge" the phyllite from which the "gouge" was formed was last crystallized some 270 million years ago and has not been subject to renewed thermal metamorphic effects subsequent to that time.

b. Features Suggestive of Glacial Origin

Glaciotectonic deformations of the weathered bedrock fault zone are characteristic structural features exposed in both trenches. In Trench A (Figure 3), large blocks of phyllite bedrock enclosed in glacial till are seen to have been forced downward into the fault zone along its northern edge, just to the west of the rock cut; felsic dike material enclosed in weathered and deformed phyllite on the east wall (Photos A-4, 5, 15) is seen to have been squeezed downward and dragged out to the southeast due to sub-glacial transport. In Trench B (Figures 3 and 5), seams of till project downward to the southeast at high angles into the bedrock to the north of the fault zone; low-angle glaciotectonic thrusting or sub-glacial transport of the near-surface weathered bedrock zone has displaced slices of felsic dike material to the southeast (Figure 5, Rock Cut - Original West Wall insert; Photos B-3, 8). These features indicate that the weathered bedrock of the fault zone has been incompetent to resist downward-thrusting glaciotectonic deformations during successive glacial advances.

That the deformation of the till/bedrock contact overlying the weathered bedrock fault zone was generated by a form of glaciotectonic, rather than crustal tectonic, force is indicated by:

- i. low-angle, outward-directed overthrust shearing of the bedrock between faults in Trench A (Figure 4, Rock Cut - West Wall insert; Photos A-12, 13, 14);
- ii. the squeezing of plastic "gouge" material not only upward into the till, but also laterally into hard rock re-entrants in the walls adjacent to the "gouge" zone in Trench A (Figure 4, Detail at Point 11 insert; Photos A-7, 8, 10);
- iii. the features indicative of stress having been imposed downward from the northwest onto glacial sediments and weathered bedrock, immediately to the northwest of the till/bedrock deformation, as evidenced by textural differences in Laurentide till (Photos A-1, 2, 3, 6,); fold deformations in Laurentide till (Photos



A-2, 3,) and in lower till (Photos B-3, 4, 5, 6); and the depression of the glacio-marine sand-silt unit and the weathered bedrock surface in the east wall of Trench B (Figure 5, Overburden East Wall and Rock Cut-East Wall insert);

- iv. the arching of the bedrock surface in the trough of Trench B (Figure 5; Photo B-1), and the associated outward-directed overthrust ruptures and monoclinical folding of the bedrock surface in this location (Figure 5, all inserts);
- v. the lack of lateral continuity of till/bedrock deformations, including the discontinuous nature of "gouge" occurrence to the east of the rock cut in Trench A (Figure 3), and the gradual diminishing and disappearance of till/bedrock rupture deformation in Trench B (Photos B-1 through 6);
- vi. the lack of chaotic deformation of Laurentide till above the "gouge" zone in Trench A (Photos A-1, 2, 3, 6, 7, 8, 9, 10, 11);

The last imposition of major stress on the weathered bedrock zone is seen logically to have occurred when the entire bedrock mass was loaded by the last Wisconsinan continental ice sheet which moved over the area and retreated during the period 22,000 to 12,800 years ago. This ice sheet, which overrode mile-high Mt. Katahdin in north-central Maine, 100 miles (160 km.) to the north of the site, and extended to Georges Bank at the south margin of the Gulf of Maine, 180 miles (300 km.) to the south-southeast of the site, would have loaded the site with several thousand feet (more than 1000 m.) of glacial ice at its maximum stage of development.

Stress developed by ice-loading of the hard bedrock of the ridges which sandwich the weathered bedrock trough would, upon unloading at the time of ice retreat, achieve relief not only upward but also laterally by squeezing the incompetent weathered materials of the bedrock trough. This is explained by the difference between Poisson's ratio for the hard bedrock and the "gouge" as described in Model 1 of Appendix D. Another means by which the weathered bedrock materials could have been squeezed is explained by Model 2 of Appendix D. In this case, a horizontal stress is induced from the northwest side of the weathered rock zone due to the glacier's weight and base shear. The presence of an isolated residual mass of ice resting on the hard-rock area just to the northwest of the deformed zone in the bedrock trough is indicated by the distribution of ablation till and proglacial outwash deposits, interpreted to be about 12,800 years old (Figure 6). This ice mass, although possibly only two hundred feet (60 m.) thick, would have to some degree inhibited uniform vertical and horizontal relief of stress within the hard-soft-hard bedrock sandwich of the trench area, and would have favored a slight differential relief of the southeast block relative to the northwest block upon rebound of the bedrock adjacent to the weathered bedrock zone. A resultant northwest-directed overthrust squeezing of the incompetent bedrock materials of the bedrock trough would have been generated.

Observations of the glacial and bedrock geologic and structural features exposed in Trenches A and B indicate that the various deformations of the till/bedrock contact in these trenches were formed essentially contemporaneously due to differential stress relief of the bedrock. The time of deformation seems most logically to relate to the time of final retreat of glacial ice from the site, interpreted from regional studies to have been about 12,800 years ago.

## References

1. Analytical Chemical Services (1976) Letter to Geotechnical Engineers, Inc., on percent carbon in GEI Sample 26 from Trench A.
2. Andrews, J. T. (1974) Introduction in Glacial Isostasy. Dowden, Hutchinson & Ross, Inc.; Stroudsburg, PA; 1974.
3. Belknap, D. F. (1973) Source, Dispersion, and Texture of the Beach Gravels, Wells Beach, Maine. Unpublished report done as an independent study project at Bowdoin College, Brunswick, Maine.
4. Belt, E. S. (1968) Post-Acadian Rifts and Related Facies, Eastern Canada, in Studies of Appalachian Geology: Northern and Maritime. Wiley-Interscience; John Wiley & Sons; New York.
5. Bloom, A. L. (1963) Late-Pleistocene Fluctuations of Sea Level and Postglacial Crustal Rebound in Coastal Maine: American Journal of Science, Vol. 261, p. 862-879.
6. Borns, H. W. (1975) Personal Communication.
7. Borns, H. W. (1974) Recession of the Late Wisconsin Laurentide Ice Sheet in Eastern Maine, in Geology of East-Central and North-Central Maine. New England Intercollegiate Geological Conference, 66th Annual Meeting; October 12 and 13, p. 23-27.
8. Borns, H. W. (1967) Guidebook, Friends of the Pleistocene, 30th Annual Reunion, Machias, Maine; May 20-21.
9. Borns, H. W. (1973) Late Wisconsin Fluctuation of the Laurentide Ice Sheet in Southern and Eastern New England: Geological Society of America Memoir 136; p. 37-45.
10. Borns, H. W., and Calkin, P. E. (1970) Multiple Glaciation and Dissipation of the Last Ice Sheet in Northwestern Maine: Geological Society of America, Abstract with Programs; Vol. 2, No. 1, p. 12.
11. Borns, H. W.; Davis, R. B.; and Sanger, D. (1974) Late Wisconsin and Holocene Geological, Botanical, and Archaeological History of the Orono, Maine, Region, in Geology of East-Central and North-Central Maine. New England Intercollegiate Geological Conference, 66th Annual Meeting; October 12 & 17, p. 136-139.
12. Borns, H. W., and Hagar, D. J. (1965) Late-Glacial Stratigraphy of a Northern Part of the Kennebec River Valley, Western Maine: Geological Society of America Bulletin, Vol. 76, p. 1233-1250.
13. Broecker, W. S. (1965) Isotope Geochemistry and the Pleistocene Climatic Record, in The Quarternary of the United States, ed. Wright, H. E., and Frey, D. G.; Princeton University Press; Princeton, New Jersey.

14. Broecker, W. S. (1966) Glacial Rebound and the Deformation of the Shorelines of Proglacial Lakes, in *Glacial Isostasy*. Dowden, Hutchinson & Ross, Inc.; Stroudsburg, Pa.; 1974.
15. Brotchie, J. F. and Silvester, R. (1969) On Crustal Flexure, in *Glacial Isostasy*. Dowden, Hutchinson & Ross, Inc.; Stroudsburg, PA; 1974.
16. Caldwell, D. W. (1975) Personal Communication.
17. Caldwell, D. W. (1959) Glacial Lake and Glacial Marine Clays of the Farmington Area: Maine, Maine Geological Survey, Special Geologic Studies Series #3. Department of Economic Development; Augusta, Maine; 48 p.
18. Chapman, C. A. (1970) *The Geology of Acadia National Park*. Chatham Press, Inc.; p. 29.
19. CLIMAP Project Members (1976) The Surface of the Ice-Age Earth: *Science*, Vol. 191, No. 4232; p. 1131-1137.
20. Conley, J. F., and Drummond, K. M. (1965) Faulted Alluvial and Colluvial Deposits Along the Blue Ridge Front near Saluda, North Carolina: *Southeastern Geol.*, Vol. 7, No. 1, p. 35-39.
21. Crandell, D. R. (1965) The Glacial History of Western Washington and Oregon, in *The Quaternary of the United States*; ed. Wright, H. E., and Frey, D. G.; Princeton University Press; Princeton, New Jersey.
22. Crosbie-Macomber Paleontological Laboratory, Inc. (1975) Letter to GEI containing results of fossil search in GEI Sample B-F103-II and B-F104-III from Trench B.
23. Curray, J. R. (1965) Late Quaternary History, Continental Shelves of the United States, in *The Quaternary of the United States*; ed. Wright, H. E., and Frey, D. G.; Princeton University Press; Princeton, New Jersey.
24. DeGeer, Baron Gerard (1892) On Pleistocene Changes of Level in Eastern North America, in *Glacial Isostasy*. Dowden, Hutchinson & Ross, Inc.; Stroudsburg, Pa.; 1974.
25. Dobkins, J. E., Jr., and Folk, R. L. (1970) Shape Development on Tahiti-Nui: *Journal of Sedimentary Petrology*, Vol. 40, No. 4, p. 1167-1203.
26. Drake, L. (1971) Evidence for Ablation and Basal Till in East-Central New Hampshire, in *Till/A Symposium*; ed. Goldthwait R. P.; Ohio State University Press; Columbus, Ohio, p. 73-91.
27. Dreimanis, A., and Karrow, P. F. (1972) Glacial History of the Great Lakes - St. Lawrence Region, the Classification of The Wisconsin(an) Stage, and its Correlatives; 24th IGC, Section 12; Canada, p. 5-15.

28. Evenson, E. B. (1971) The Relationship of Macro- and Micro-fabric of Till and the Genesis of Glacial Landforms in Jefferson County, Wisconsin, in Till/A Symposium; ed. Goldthwait, R. P.; Ohio State University Press; Columbus, Ohio, p. 345-364.
29. Farrand, W. R. (1962) Postglacial Uplift in North America, in Glacial Isostasy. Dowden, Hutchinson & Ross, Inc.; Stroudsburg, PA; 1974.
30. Fillon, R. H. (1972) Possible Causes of the Variability of Post-glacial Uplift in North America, in Glacial Isostasy. Dowden, Hutchinson & Ross, Inc.; Stroudsburg, PA; 1974.
31. Flint, R. F., et. al. (1959) Glacial Map of the United States East of the Rocky Mountains. Geological Society of America.
32. Flint, R. F. (1971) Glacial and Quaternary Geology. John Wiley & Son; New York, 892 p.
33. Flint, R. F. (1956) New Radiocarbon Dates and Late-Pleistocene Stratigraphy: American Journal of Science, Vol. 254, p. 265-287.
34. Flint, R. F. (1953) Probable Wisconsin Substages and Late Wisconsin Events in Northeastern United States and Southeastern Canada: Bulletin of the Geological Society of America, Vol. 64, p. 897-920.
35. Geochron Laboratories Division of Krueger Enterprises, Inc. (1975) Reports to John R. Rand on the age of the following rock samples: Meta-dabase dike, SW Shore, Sears Island; Lamprophyre dike, Jameson Pt., Rockland, (2 Samples); diabase dike, Flye Point, Brooklin; Calcareous accretion, TR-B2, Sears Island; felsic dike, TR-B3, Sears Island; "gouge", A-F3, Sears Island.
36. Gilbert Associates, Inc. (1975) Geologic Investigation of a Portion of the PNPP Foundation, in The Matter of Perry Nuclear Power Plant, Cleveland Illuminating; Perry, Ohio.
37. Goldthwait, L., Clay Survey--1948, Report of the State Geologist, 1947-48, Augusta, Maine; Maine Development Commission, p. 63-69.
38. Goldthwait, R. P., Dreimanis, A., Forsyth, J. L., Karrow, P. F., and White, G. W. (1965) Pleistocene Deposits of the Erie Lobe, in The Quaternary of the United States, ed. Wright, H. E., and Frey, D. G.; Princeton University Press; Princeton, p. 85-97.
39. Gross, D. L., and Moran, S. R. (1971) Grain Size and Mineralogical Gradations within Tills of the Allegheny Plateau, in Till/A Symposium, ed. Goldthwait, R. P.; Ohio State University Press; Columbus, Ohio, p. 251-274.
40. Hester, N. C., and DuMontelle, P. B. (1971) Pleistocene Mudflow along the Shelbyville Moraine Front, Macon County, Illinois, in Till/A Symposium, ed. Goldthwait, R. P.; Ohio State University Press; Columbus, Ohio, p. 367-382.

41. Jürgenson, L. (1940) The Application of the Theories of Elasticity and Plasticity to Foundation Problems, in Contributions to Soil Mechanics, 1925-1940: Boston Society of Civil Engineers.
42. Kaye, C. A. (1964) Illinoian and Early Wisconsin Moraines of Martha's Vineyard, Massachusetts: U. S. Geological Survey, Professional Paper 501-C.
43. Kaye, C. A., and Barghoorn, E. S. (1964) Late Quaternary Sea Level Change and Crustal Rise at Boston, Massachusetts, with Notes on the Autocompaction of Peat: Geological Society of America Bulletin, Vol. 75, p. 63-80.
44. King, P. B. (1965) Tectonics of Quaternary Time in Middle North America, in The Quaternary of the United States, ed. Wright, H. E., and Frey, D. G.; Princeton University Press; Princeton, New Jersey.
45. Koons, D. (1975) Personal Communication.
46. Kupsch, W. O. (1967) Postglacial Uplift – A Review, in Glacial Isostasy. Dowden, Hutchinson & Ross, Inc., Stroudsburg, PA; 1974.
47. LaGatta, D. P. (1970) Residual Strength of Clays and Clay Shales by Rotation Shear Tests. Doctoral thesis, Harvard University, Cambridge.
48. Langway, C. C., Jr.; Dansgaard, W.; Johnsen, S. J.; and Clausen, H. (1973) Climatic Fluctuations During the Late Pleistocene: Geological Society of America, Memoir 136, p. 317-321.
49. Lawson, A. C. (1911) On Some Post-Glacial Faults Near Banning, Ontario: Bull. Seism. Sol. Am., Vol. 1, No. 4, p. 159-166.
50. Leavitt, W. H., and Perkins, E. H. (1934) A Survey of Road Materials and Glacial Geology of Maine, Volume I, Part I: A Survey of Road Materials of Maine: Their Occurrence and Quality. Maine Technology Experiment Station, Bulletin No. 30, University Press, University of Maine; Orono, Maine.
51. Leavitt, W. H., and Perkins, E. H. (1934) A Survey of Road Materials and Glacial Geology of Maine, Volume I, Part II; Maps showing Locations of Road Materials. Maine Technology Experiment Station, Bulletin No. 30, University Press, University of Maine; Orono, Maine.
52. Leavitt, W. H., and Perkins, E. H. (1935) A Survey of Road Materials and Glacial Geology of Maine, Volume II; Glacial Geology of Maine. Maine Technology Experiment Station, Bulletin No. 30, University Press, University of Maine; Orono, Maine.
53. Macar, P. (1969) A Peculiar Type of Fossil Ice Fissure, in The Periglacial Environment, Past and Present, ed. Pewe, T. L.; McGill-Queen's University Press; Montreal, p. 337-346.

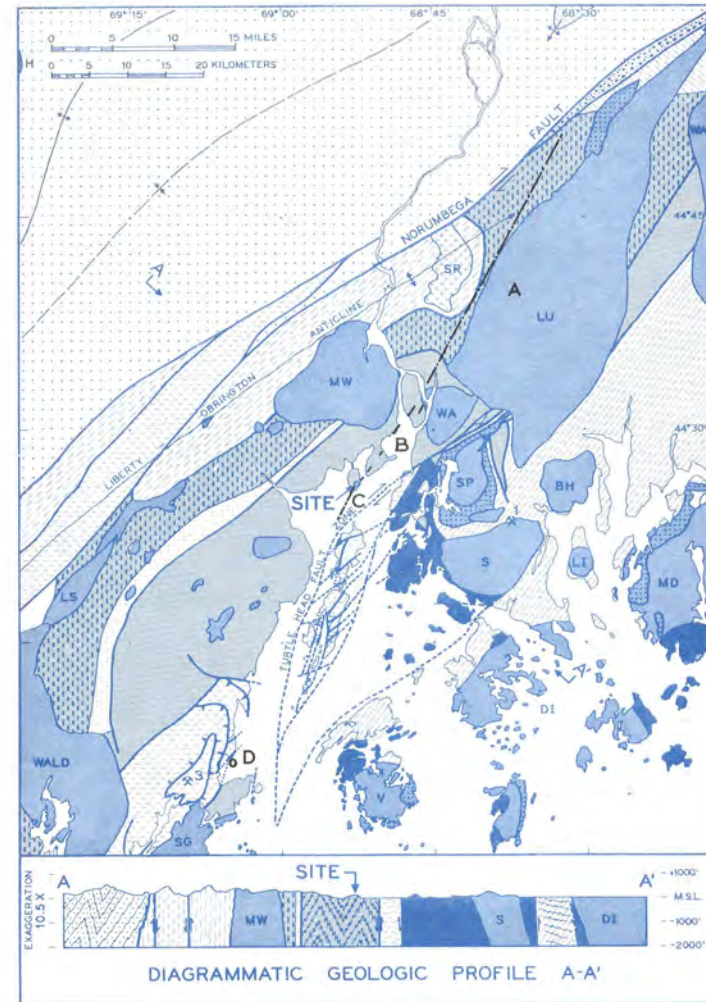
54. Matthew, G. F. (1894) Movements of the Earth's Crust at St. John, N.B., In Post-Glacial Times: Bulletin of the Natural History Society, Article III, p. 34-42.
55. Mellor, M. (1976) Telephone Communications with GEI. Cold Regions Research and Engineering Laboratory, Hanover, NH
56. Milliman, J. D., and Emery, K. O. (1968) Sea Levels during the Past 35,000 Years: Science, Vol. 162, p. 1121-1123.
57. Mills, H. C., and Wells, P. D. (1974) Ice-Shove Deformation and Glacial Stratigraphy of Port Washington, Long Island, New York: Geological Society of America Bulletin, Vol. 85, p. 357-364.
58. Moran, S. R. (1971) Glaciotectonic Structures in Drift, in Till/A Symposium, ed. Goldthwait, R. P.; Ohio State University Press; Columbus, Ohio, p. 127-148.
59. Mörner, Nils-Axel (1971) Eustatic Changes During the Last 20,000 Years and a Method of Separating the Isostatic and Eustatic Factors in an Uplifted Area, in Glacial Isostasy. Dowden, Hutchinson, & Ross, Inc.; Stroudsburg, PA; 1974.
60. Mörner, Nils-Axel (1972) World Climate During the Last 130,000 Years. 24th IGC, Section 12, p. 72-79.
61. McConnell, R. K., Jr. (1968) Viscosity of the Mantle from Relaxation Time Spectra of Isostatic Adjustment, in Glacial Isostasy. Dowden, Hutchinson & Ross, Inc.; Stroudsburg, Pa.; 1974.
62. McDonald, B. C. (1968) Deglaciation and Differential Postglacial Rebound in the Appalachian Region of Southeastern Quebec: Journal of Geology, Vol. 76, p. 664-677.
63. Newland, D. H. (1933) Earthquakes in New York State: New York State Museum, Circular 14; Albany, New York, p. 18.
64. Newman, W. S.; Fairbridge, R. W.; and March, S. (1971) Marginal Subsidence of Glaciated Areas: United States, Baltic and North Seas, in Glacial Isostasy. Dowden, Hutchinson & Ross, Inc.; Stroudsburg, PA; 1974.
65. Occhietti, S. (1973) Les Structures et Déformations Engendrées par les Glaciers - Essai de Mise au Point: Rev. Geogr. Montr., Vol. XXVII, No. 4, p. 365-380.
66. Oliver, J.; Johnson, T.; and Dorman, J. (1970) Postglacial faulting and seismicity in New York and Quebec: Canadian Journal of Earth Sciences, Vol. 7, Number 2, p. 579-590.
67. Osberg, P. H. (1974) Foreword, in Guidebook for Field Trips in East-Central and North-Central Maine. New England Intercollegiate Geological Conference, 66th Annual Meeting; Orono, Maine.

68. The Penobscot Bay Resource Plan (1972) Maine State Planning Office; Augusta, Maine, 38 p. and Appendices.
69. Physical Resources of Knox County, Maine (1974) Maine Geological Survey, Physical Resources Services, PR 1, compiled by Caswell, W. Bradford, Jr.
70. Pitman, W. C. and Talwani, M. (1972) Sea-Floor Spreading in the North Atlantic: Geological Society of America Bulletin, Vol. 83, p. 619-646.
71. Prescott, G. C. (1974) Ground-Water Favorability and Surficial Geology of the Cherryfield-Jonesboro Area, Maine. Hydrologic Investigations Atlas HA-529, Department of the Interior, U.S.G.S.
72. Prescott, G. C. (1974) Ground-water Favorability and Surficial Geology of the Machias-Lubec Area, Washington County, Maine. Hydrologic Investigations Atlas, HA-535, Department of the Interior, U.S.G.S.
73. Prescott, G. C. (1966) Surficial Geology and Availability of Ground Water in Part of the Lower Penobscot River Basin, Maine. Hydrologic Investigations Atlas HA-225, Department of the Interior, U.S.G.S.
74. Poulos, H. E., and Davis, E. H. (1974) Elastic Solutions for Soil and Rock Mechanics. Wiley; New York.
75. Quedemann, R. (1930) Geology of the Capital District. Albany University, State of New York.
76. Ruhe, R. V. (1965) Quaternary Paleopedology, in The Quaternary of the United States, ed. Wright, H. E., and Frey, D. G.; Princeton University Press; Princeton, New Jersey.
77. Sbar, M. L., and Sykes, L. R. (1973) Contemporary Compressive Stress and Seismicity in Eastern North America - An Example of Intra-Plate Tectonics: Geological Society of America Bulletin, Vol. 84, p. 1861-1882.
78. Schafer, J. P., and Hartshorn, J. H. (1965) The Quaternary of New England, in The Quaternary of the United States, ed., Wright, H. E., and Frey, D. G., Princeton University Press, Princeton, New Jersey.
79. Schlee, J., and Pratt, R. M. (1970) Atlantic Continental Shelf and Slope of the United States, Gravels of the Northeastern Part. U. S. Geological Survey Professional Paper 529-H, 39 p.
80. Shepard, F. P., Trefethen, J. M., and Cohee, G. V. (1934) Origin of Georges Bank: Bulletin, Geological Society of America, Vol. 45, p. 281-302.
81. Simmons, G., and Richter, D. (1975) Reports to GEI on the Mineralogy and Petrography of the following samples: CM-1, -2, -3, -4, -5, -6, -8, -10, -12, -13, from till samples 1,

- 2, 22 and 23 from Trench A; and B-F103-I, B-F107-IV, B-F110-V, B-F114-VII and B-F115-VI from Trench B.
82. Simmons, G. and Richter, D. (1975) Reports to J. R. Rand on the petrography of the following samples: TR-B1, TR-B2, and TR-B3 from Trench B.
  83. Smith, G. O., Bastin, E. S., and Brown, C. W. (1907) Penobscot Bay Folio 149. U. S. Geological Survey; Washington, D. C.
  84. Stewart, D. B. (1974) Precambrian Rocks of Seven Hundred Acre Island and Development of Cleavage in the Islesboro Formation, in Guidebook for Field Trips in East-Central and North-Central Maine. New England Intercollegiate Geological Conference, 66th Annual Meeting; Orono, Maine.
  85. Stewart, D. B. and Wones, D. R. (1974) Bedrock Geology of Northern Penobscot Bay Area, in Guidebook for Field Trips in East-Central and North-Central Maine. New England Intercollegiate Geological Conference, 66th Annual Meeting; Orono, Maine.
  86. Stone & Webster Corp. (1970) Final Safety Analysis Report, in The Matter of James A. Fitzpatrick Nuclear Power Plant, Power Authority of the State of New York.
  87. Stuiver, M. and Borns, H. W., (1967) Deglaciation and Early Postglacial Submergence in Maine. Geological Society of America, Abstract for 1967, Spec. Paper 115, p. 59-60.
  88. Stuiver, M., and Borns, H. W. (1975) Late Quaternary Marine Invasion in Maine: Its Chronology and Associated Crustal Movement: Geological Society of America Bulletin, Vol. 86, p. 99-104.
  89. Sweeney, J. F. (1976) Subsurface Distribution of Granitic Rocks, South-Central Maine: Geological Society of America Bulletin, Vol. 87, p. 241-249.
  90. Walcott, R. J. (1970) Isostatic Response to Loading of the Crust in Canada, in Glacial Isostasy. Dowden, Hutchinson & Ross, Inc.; Stroudsburg, PA; 1974.
  91. Washburn, A. L., and Stuiver, M. (1962) Radiocarbon-dated Postglacial Deleveling in North-East Greenland and Its Implications: Journal of the Arctic Institute of North America, Volume 15, Number 1, p. 66-73.
  92. Weed, E.G.A.; Minard, J. P.; Perry, W. J. Jr.; Rhodehamel, E. C.; and Robbins, E. I. (1974) Generalized Pre-Pleistocene Geologic Map of the Northern United States Atlantic Continental Margin. Miscellaneous Investigations Series, Map I-861; United States Geological Survey, Department of the Interior.
  93. White, O. L.; Karrow, P. F.; and MacDonald, J. R. (1973) Residual Stress Relief Phenomena in Southern Ontario: Proceedings, 9th Canadian Rock Mechanics Symposium; Montreal, p. 323-348.

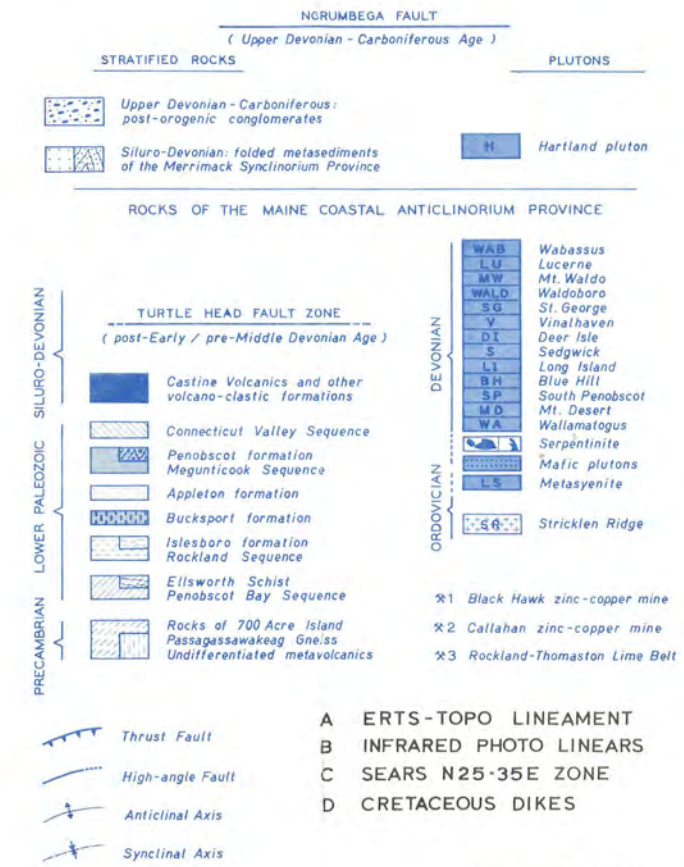


94. White, W. A. (1952) Post-Cretaceous Faults in Virginia and North Carolina: Bulletin of the Geological Society of America, Vol. 63, p. 745-747.
95. Wilson, James T. (1968) Glacial Rebound and Earthquakes: Earthquake Notes, Vol. XXXIX, p. 11-12.
96. Wones, D. R. (1975a) Personal Communication, September 12, 1975.
97. Wones, D. R. (1975b) Personal Communication, September 29, 1975.

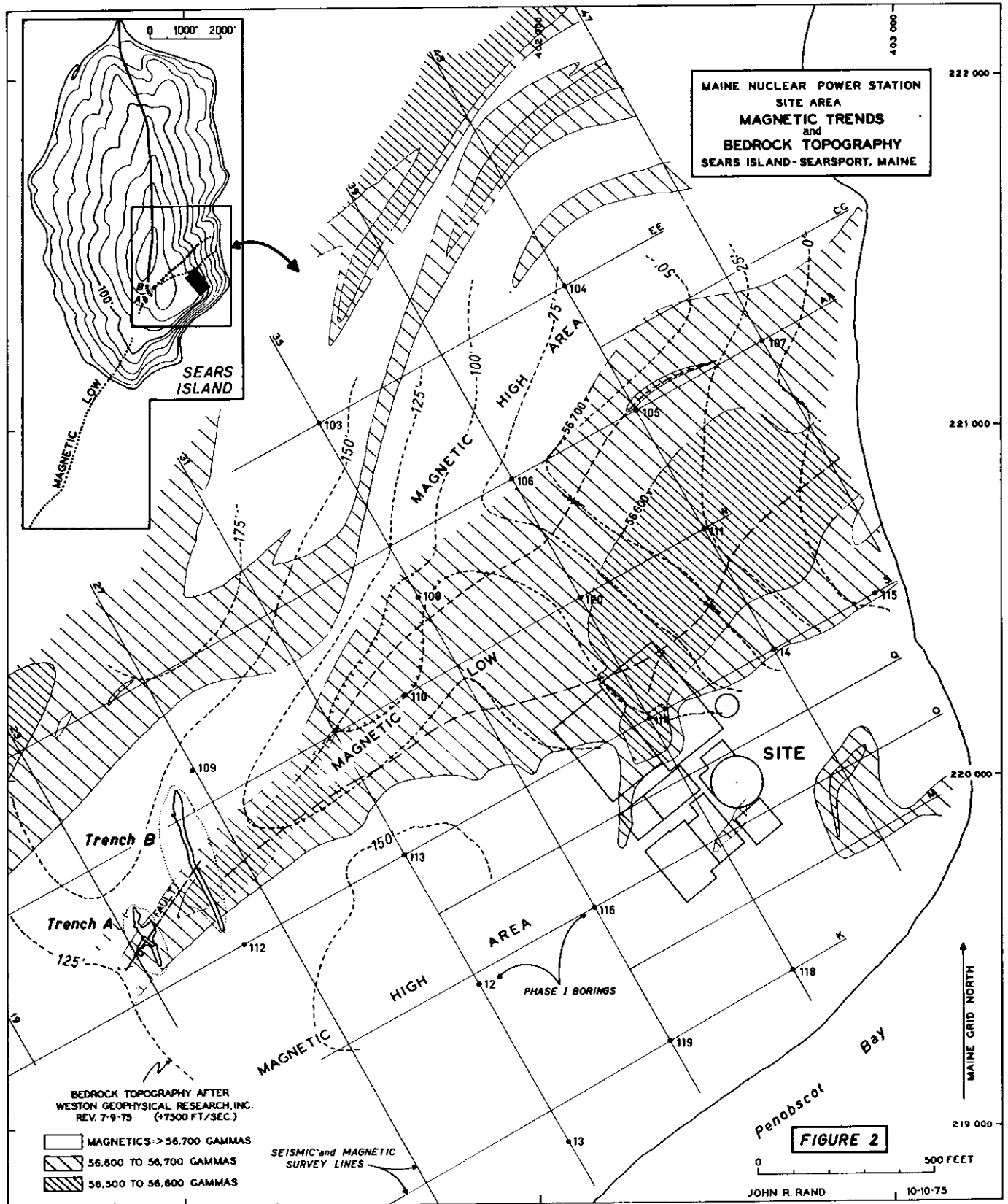


**REGIONAL GEOLOGIC SETTING - BEDROCK MAP AND PROFILE**

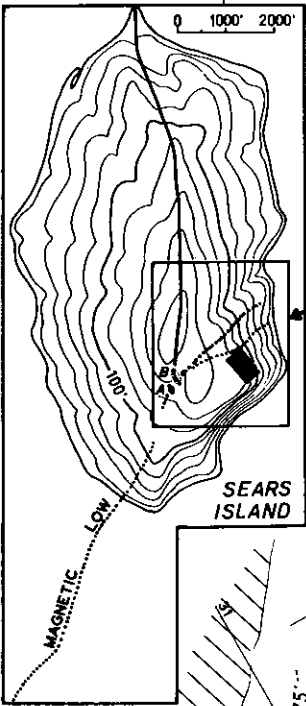
COMPILED BY JOHN R. RAND FROM SOURCES LISTED IN THE TEXT



**FIGURE 1**



MAINE NUCLEAR POWER STATION  
 SITE AREA  
 MAGNETIC TRENDS  
 and  
 BEDROCK TOPOGRAPHY  
 SEARS ISLAND-SEARSPORT, MAINE



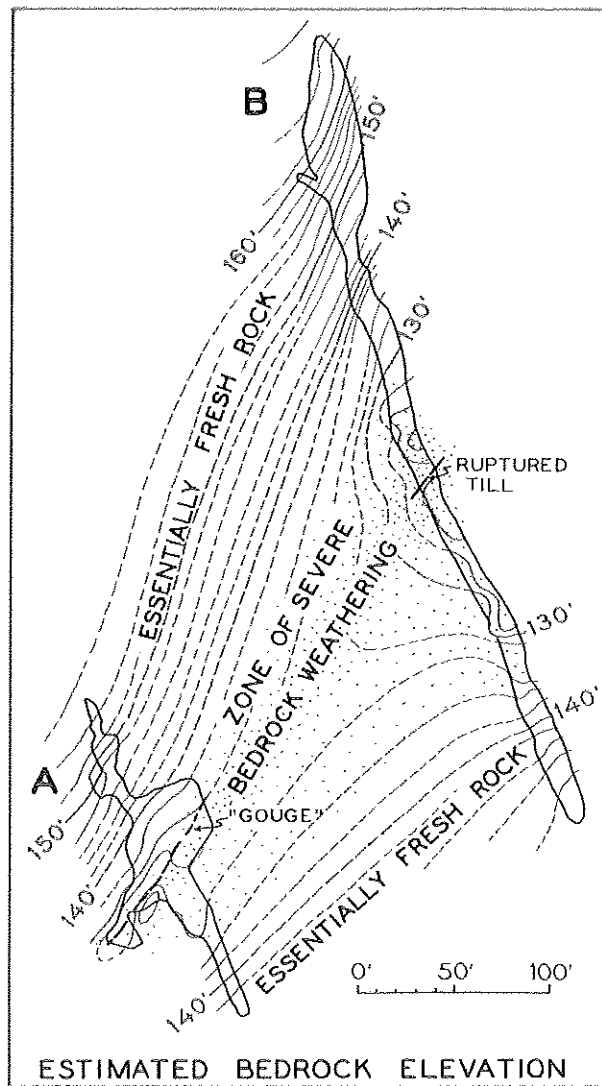
BEDROCK TOPOGRAPHY AFTER  
 WESTON GEOPHYSICAL RESEARCH, INC.  
 REV. 7-9-75 (+7500 FT/SEC.)

- MAGNETICS > 56,700 GAMMAS
- 56,800 TO 56,700 GAMMAS
- 56,500 TO 56,600 GAMMAS

SEISMIC and MAGNETIC  
 SURVEY LINES

**FIGURE 2**

JOHN R. RAND 10-10-75



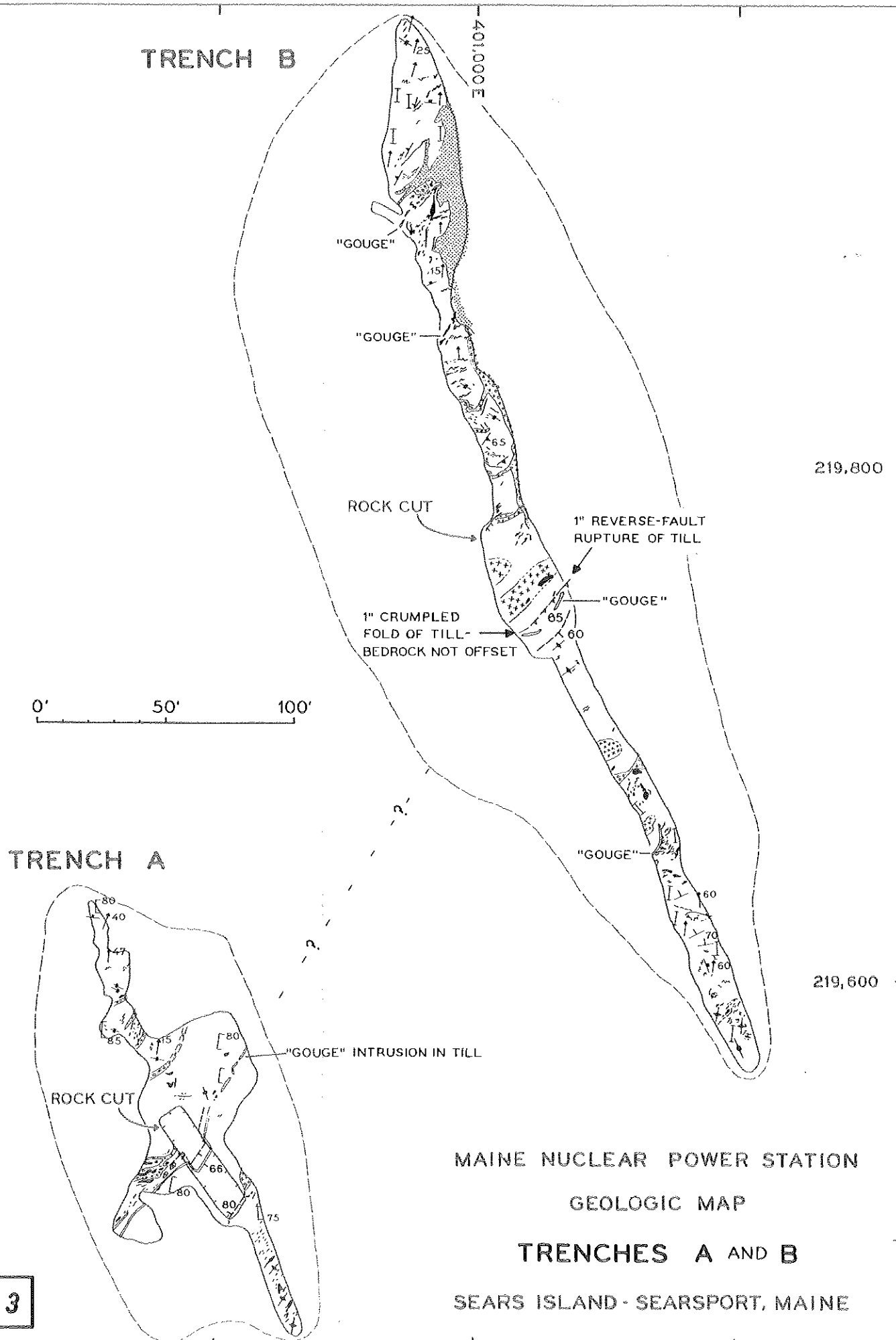
MAINE GRID NORTH

COUNTRY ROCK IS PENOBSCOT FORMATION PHYLLITE

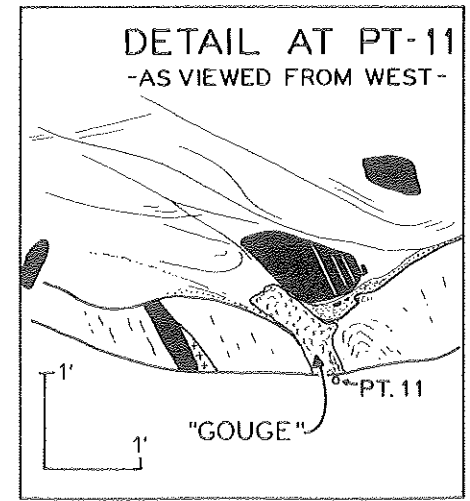
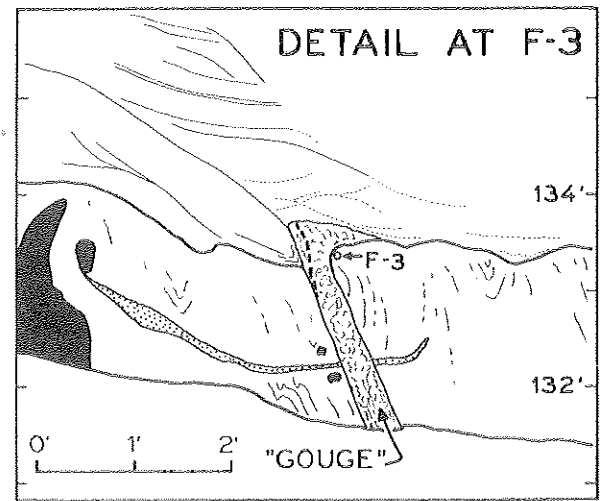
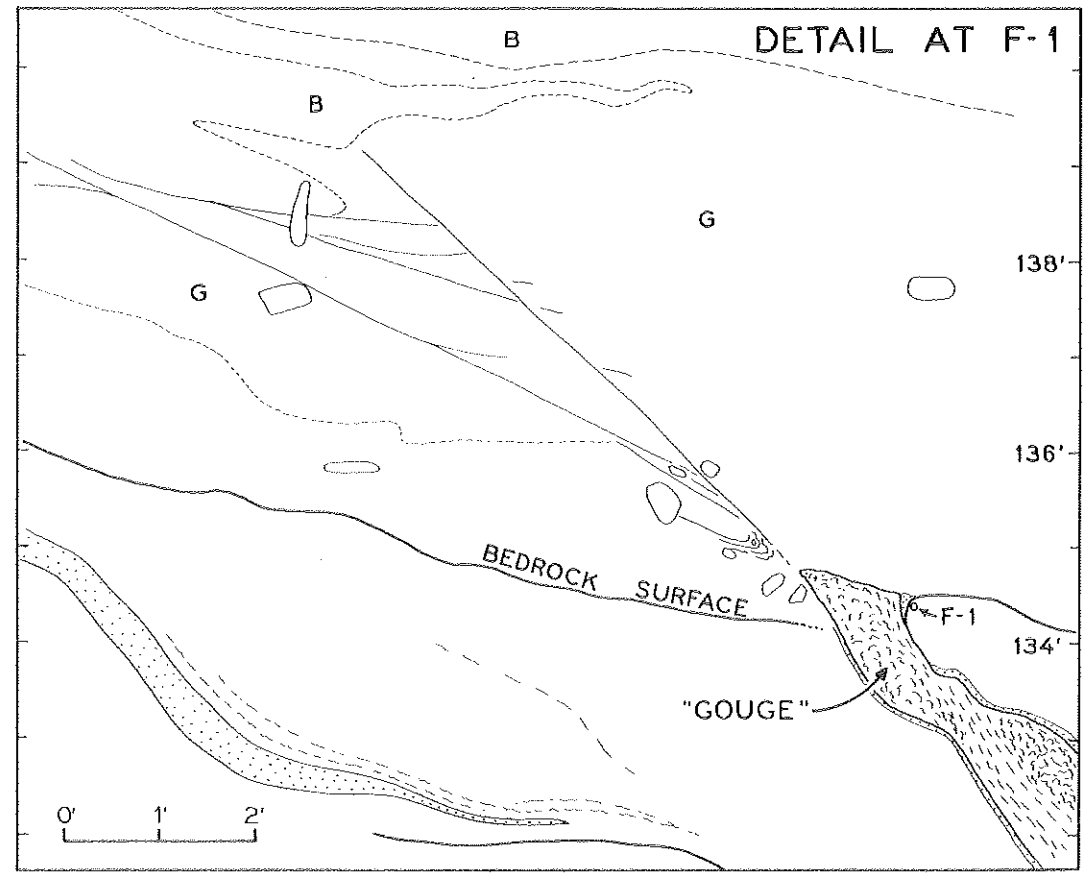
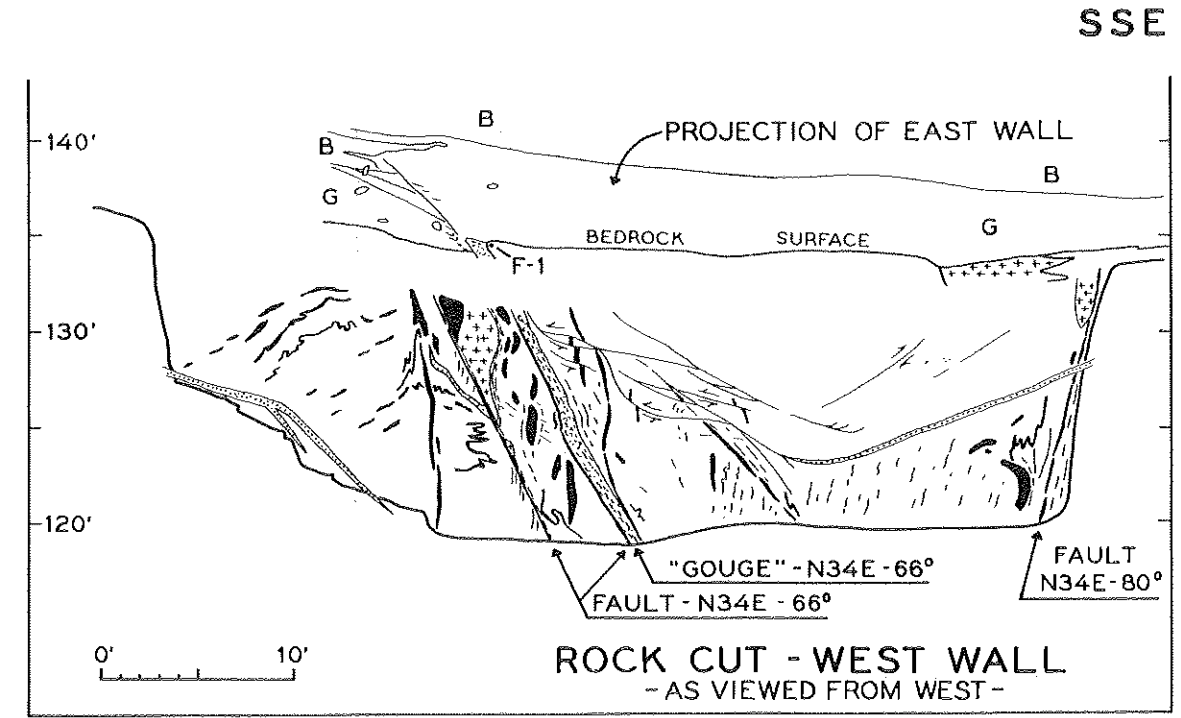
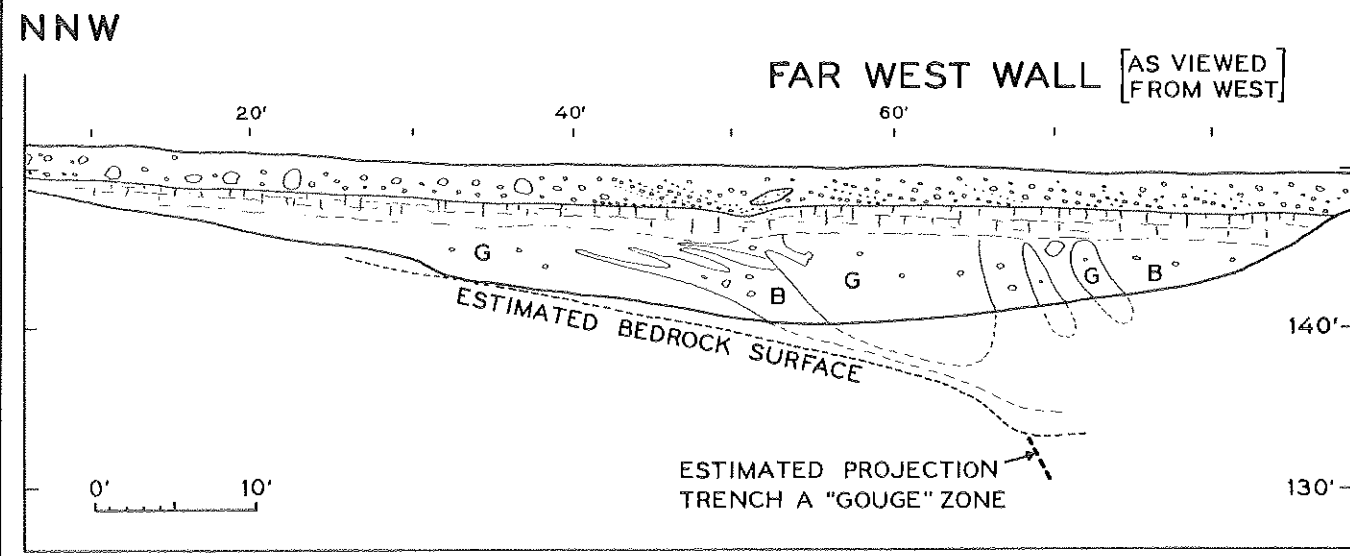
- "GOUGE": EXTREMELY WEATHERED PHYLLITE
- GLACIAL STRIATIONS - S25E
- GLACIAL TILL AND SEAM FILLINGS
- IRON-CEMENTED "FERRUGINITE"
- FELSIC DIKE MATERIAL
- QUARTZ MASSES AND VEINS
- LATE CLEAVAGE: STRIKE AND DIP
- FOLD AXIS: STRIKE AND PLUNGE
- FOLIATION: STRIKE AND DIP
- JOINTING: STRIKE AND DIP
- BEDDING: STRIKE AND DIP
- REVERSE FAULT: TEETH ON UPPER PLATE
- HIGH-ANGLE FAULT: STRIKE AND DIP

JOHN R. RAND  
1-29-76

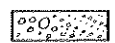
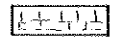
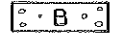
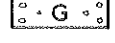

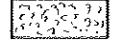
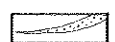

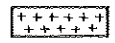

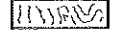
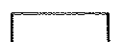
**FIGURE 3**

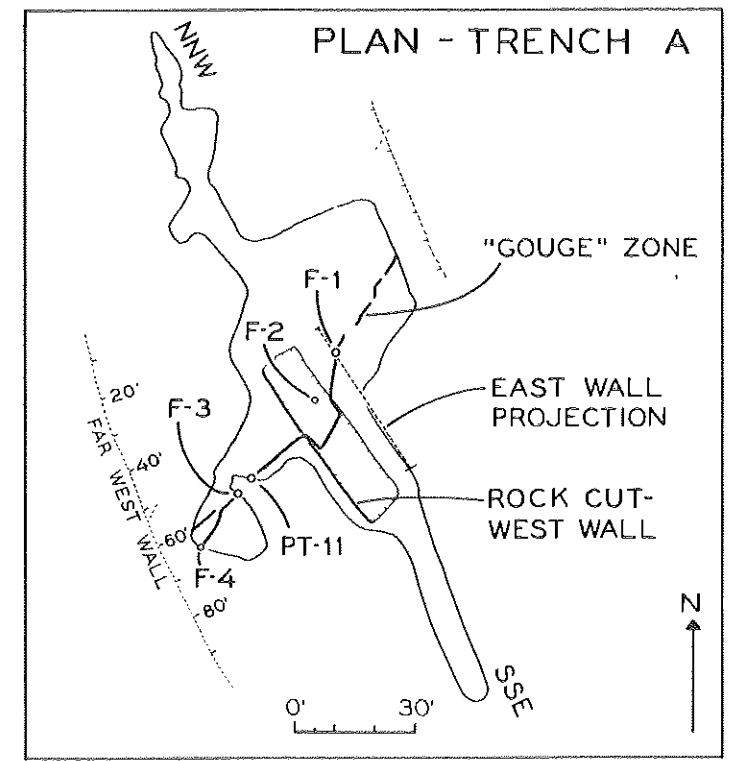


MAINE NUCLEAR POWER STATION  
GEOLOGIC MAP  
TRENCHES A AND B  
SEARS ISLAND - SEARSPORT, MAINE



COUNTRY ROCK IS PENOBSCOT FORMATION PHYLLITE

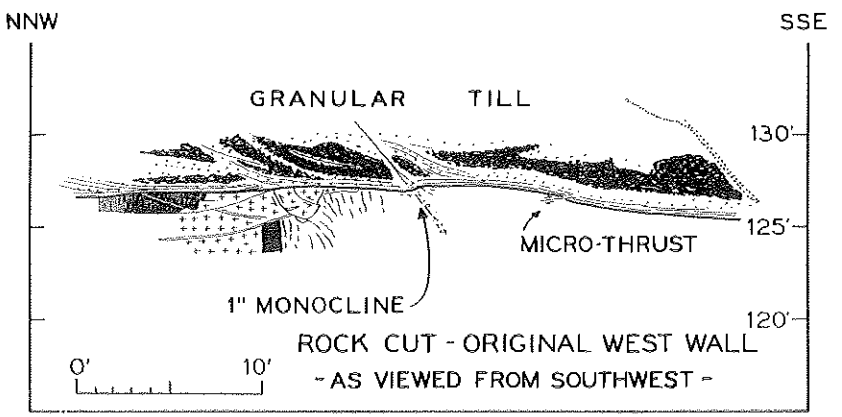
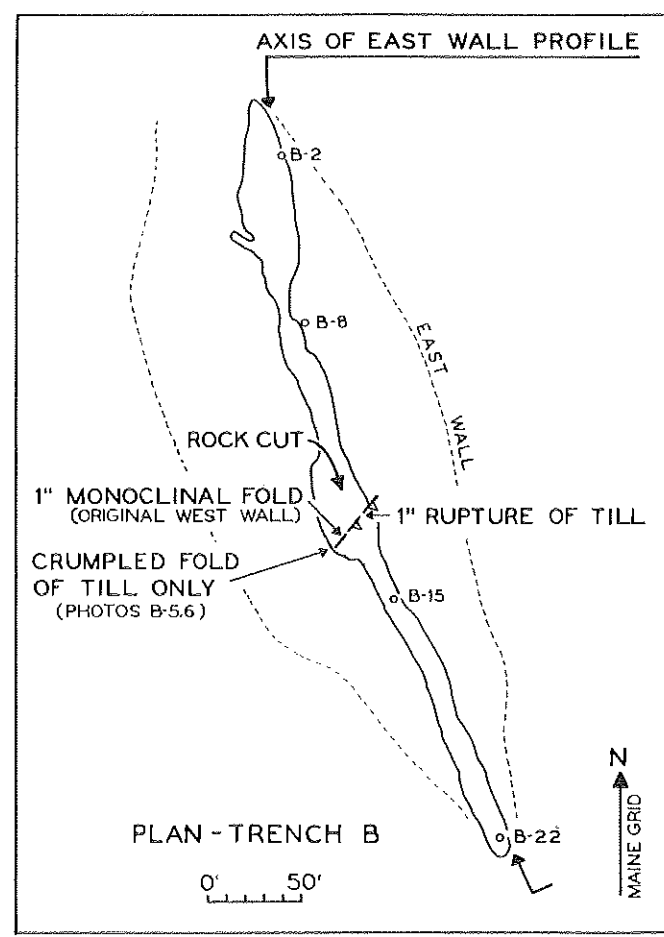
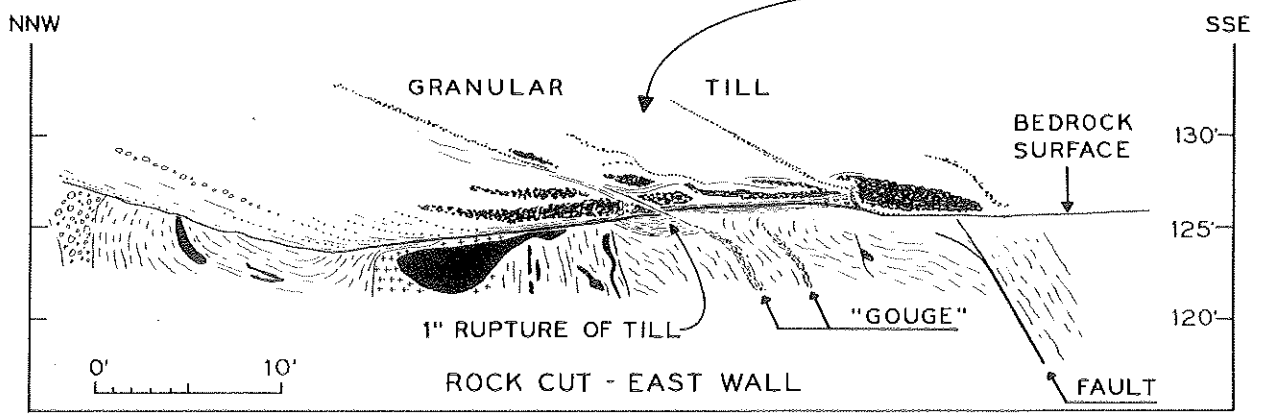
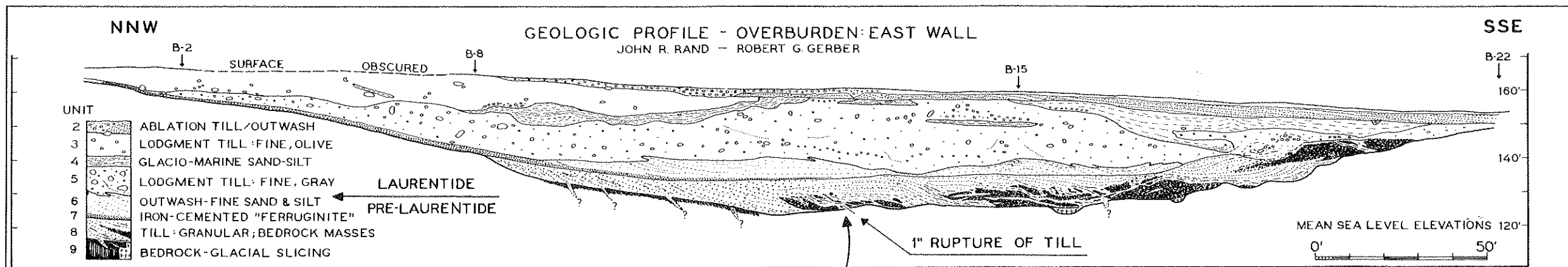
-  ABLATION TILL - OUTWASH
-  MOTTLED WEATHERING
-  LODGMET TILL - OLIVE BROWN
-  LODGMET TILL - GRAY
-  PROMINENT CRACKS IN TILL
-  "GOUGE" : EXTREMELY WEATHERED, PLASTIC PHYLLITE
-  SEDIMENT-FILLED SEAMS
-  APPARENT SHEAR PLANES IN ROCK
-  FELSIC DIKE MATERIAL
-  QUARTZ MASSES AND VEINS
-  SENSE OF FOLIATION
-  PHYLLITE BEDROCK



**FIGURE 4**

JOHN R. RAND  
11-1-75

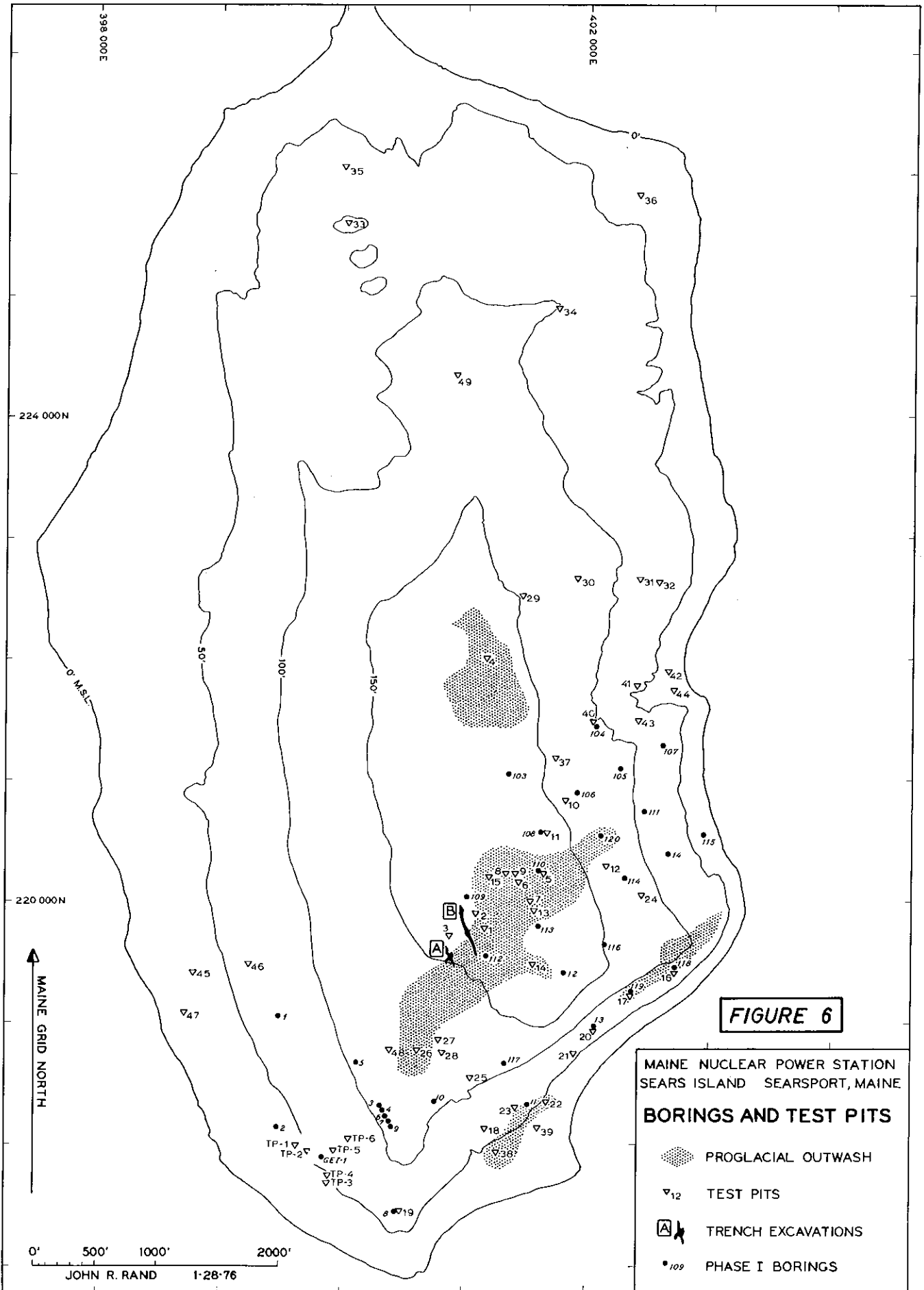
MAINE NUCLEAR POWER STATION  
GEOLOGIC PROFILES  
**TRENCH A**  
SEARS ISLAND SEARSPORT, MAINE



- RUSTY ZONES IN TILL
- "GOUGE": EXTREMELY WEATHERED, PLASTIC PHYLLITE
- TILL SEAM FILLINGS
- BEDROCK MASSES IN TILL
- FELSIC DIKE MATERIAL
- QUARTZ MASSES AND VEINS
- SENSE OF PHYLLITIC FOLIATION
- B-15 GROUND CONTROL POINT

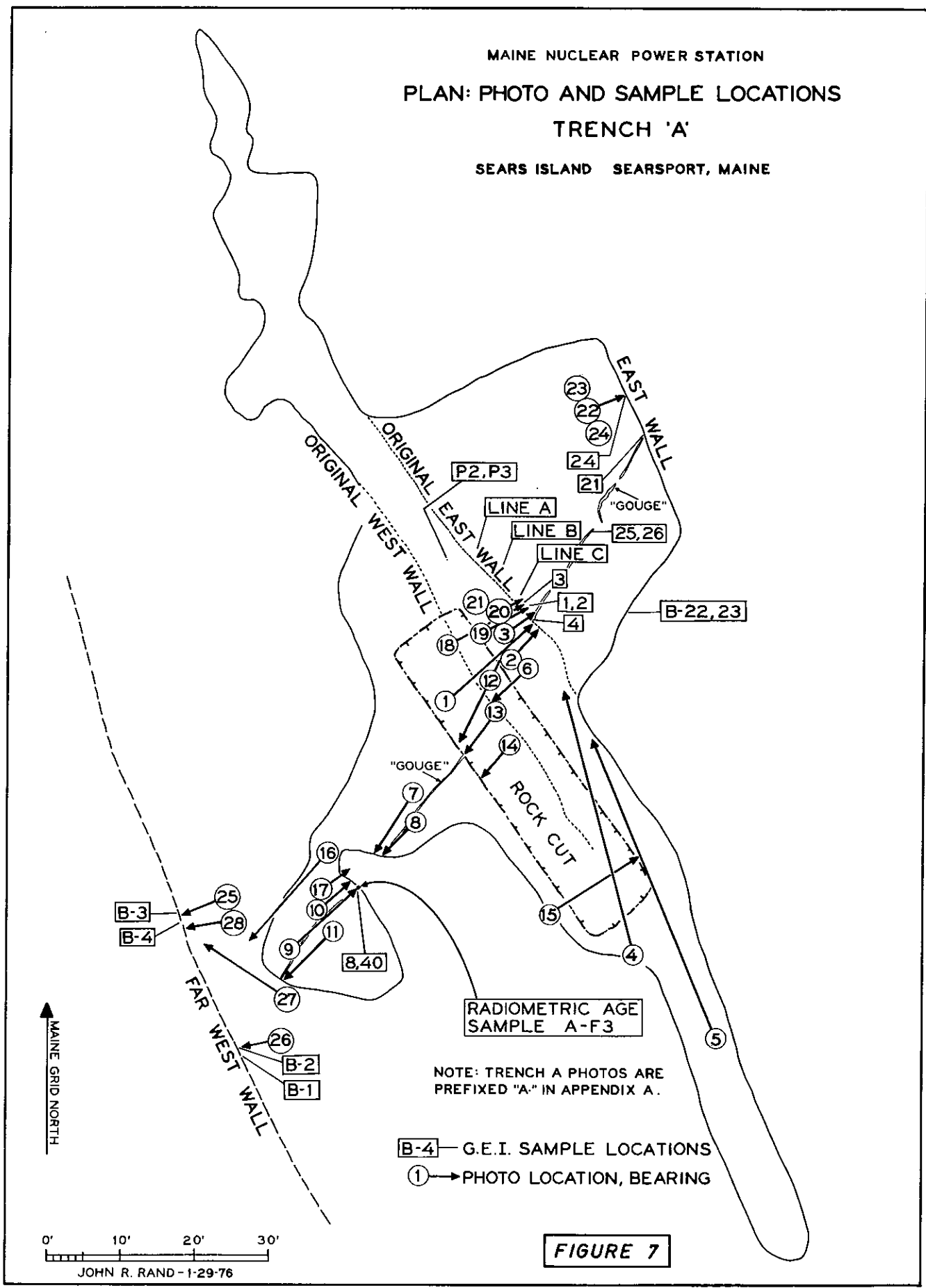
**FIGURE 5**

MAINE NUCLEAR POWER STATION  
 GEOLOGIC PROFILES  
 TRENCH B  
 SEARS ISLAND SEARSPORT, MAINE



MAINE NUCLEAR POWER STATION  
 PLAN: PHOTO AND SAMPLE LOCATIONS  
 TRENCH 'A'

SEARS ISLAND SEARSPORT, MAINE



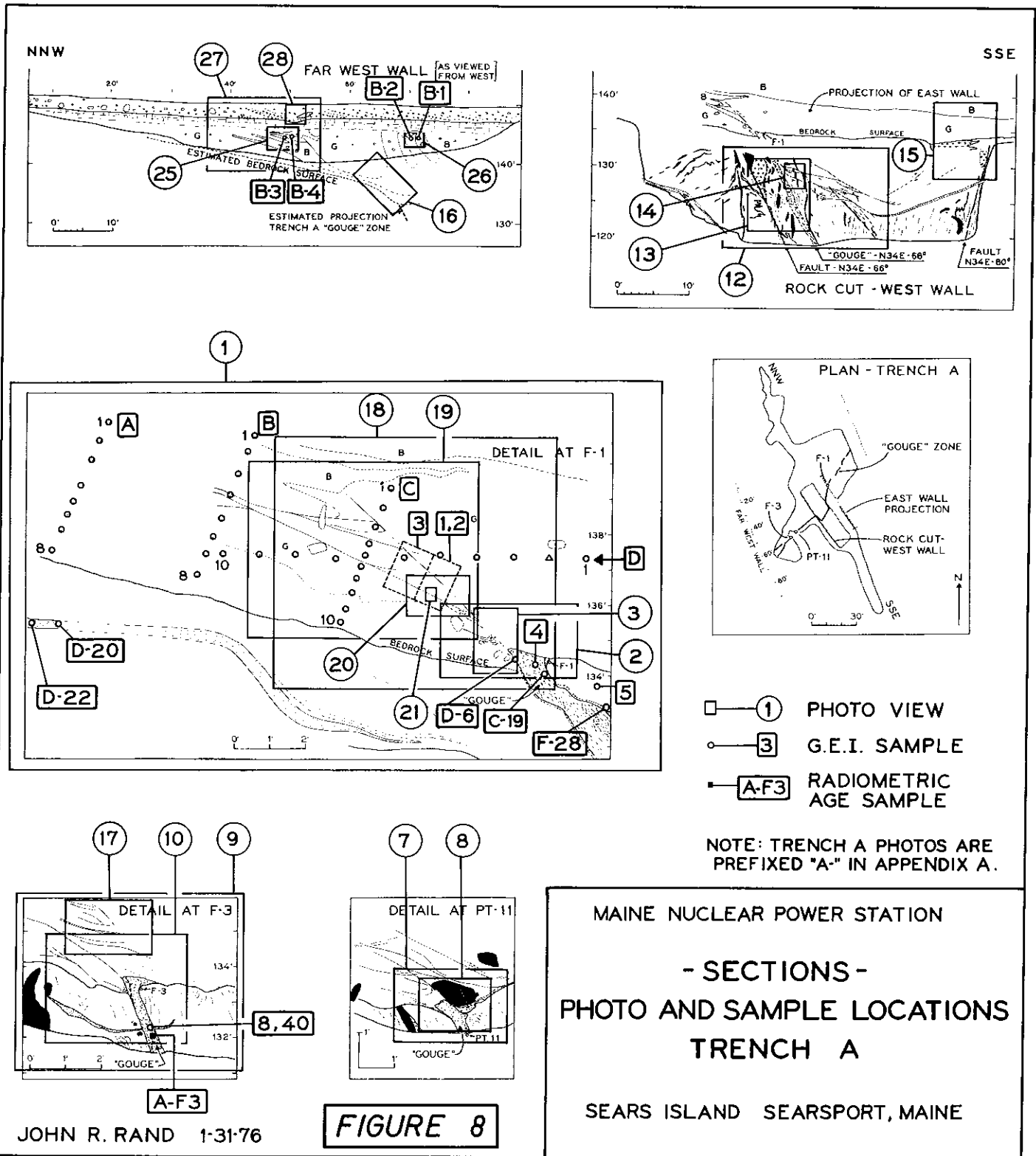
NOTE: TRENCH A PHOTOS ARE  
 PREFIXED "A." IN APPENDIX A.

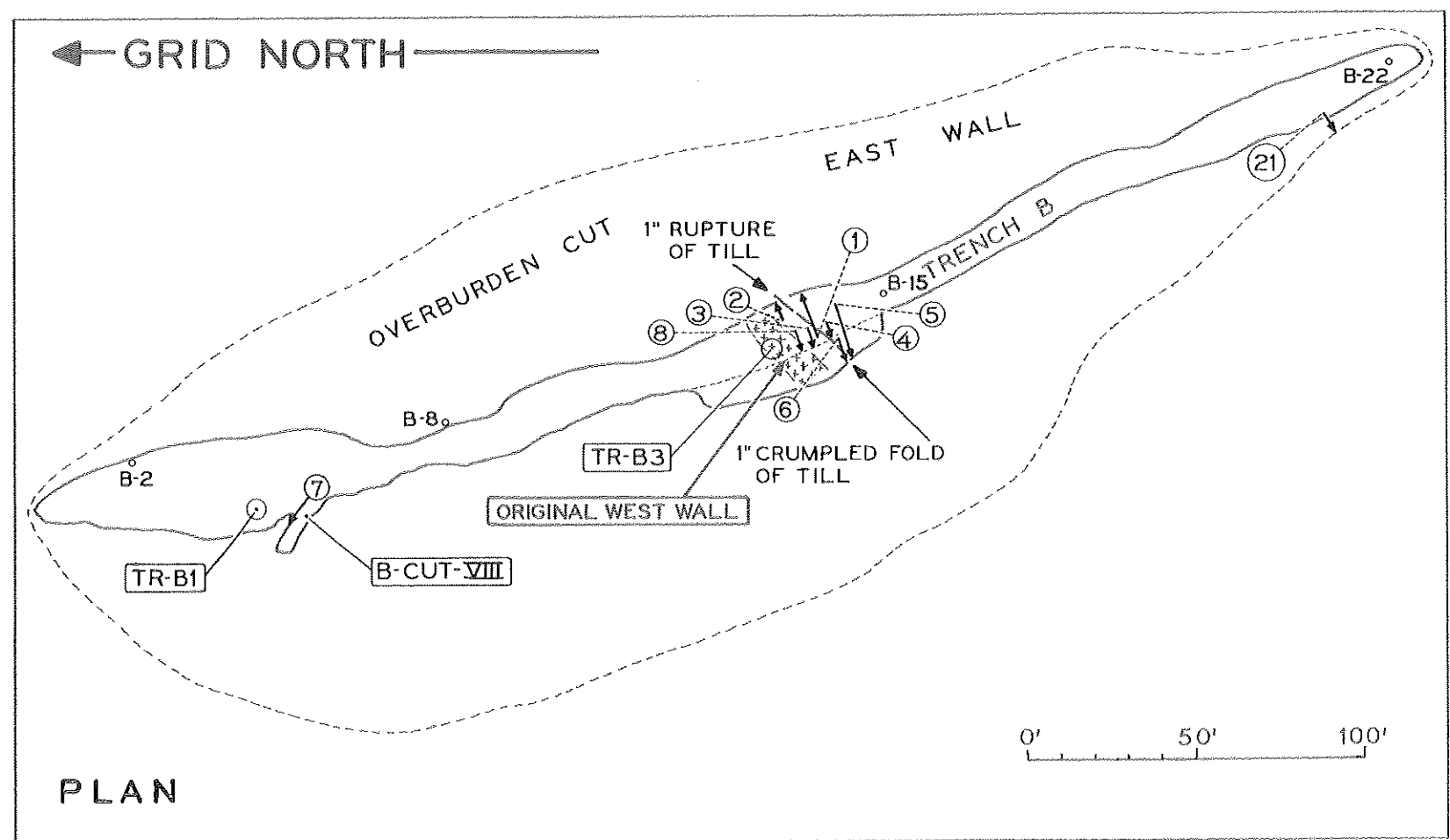
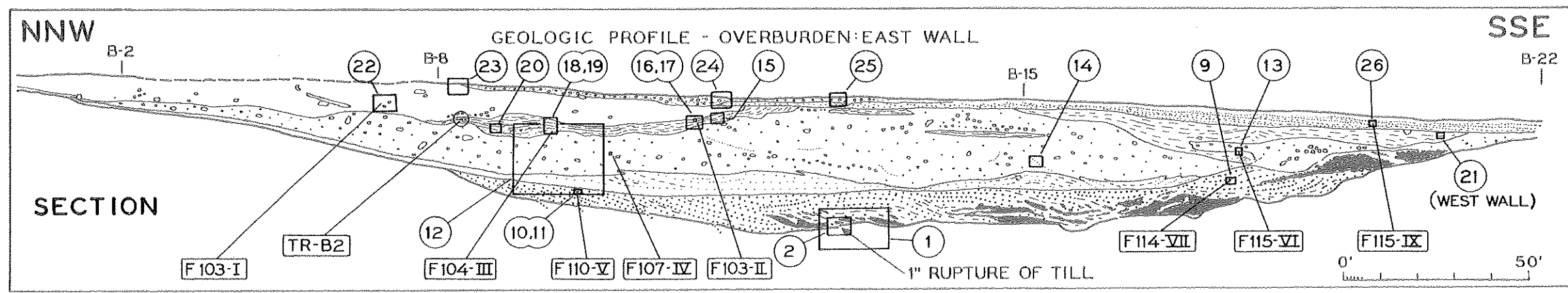
- B-4 — G.E.I. SAMPLE LOCATIONS
- ① — PHOTO LOCATION, BEARING

**FIGURE 7**

0' 10' 20' 30'  
 JOHN R. RAND - 1-29-76





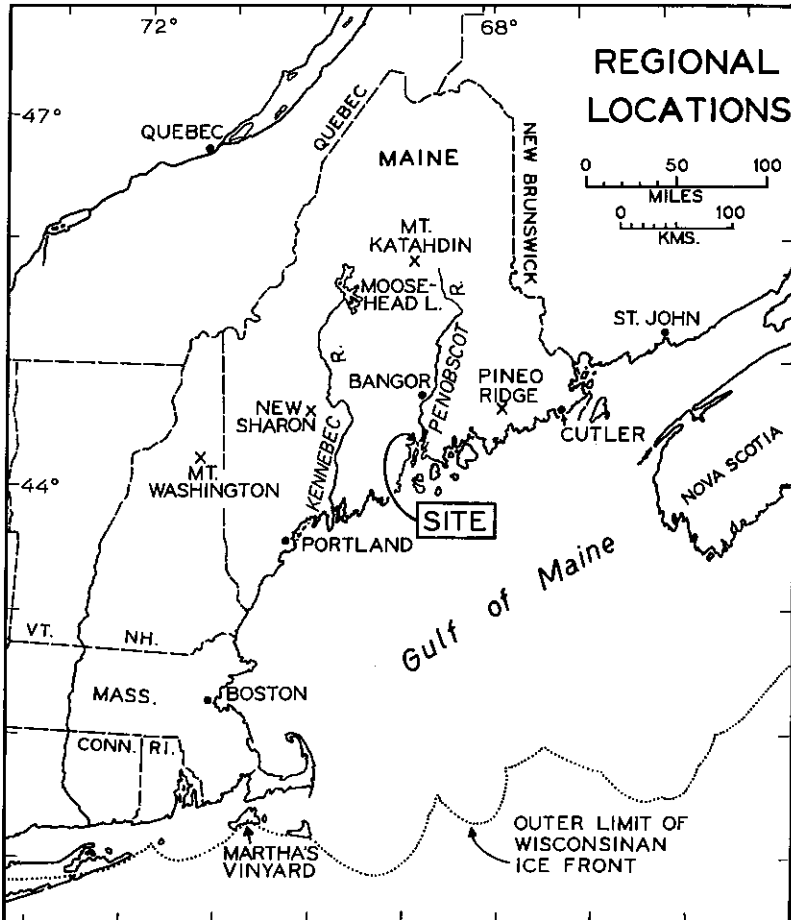


- — ① PHOTO VIEW
- F110-V G.E.I. SAMPLE
- ⊙ — TR-B1 J.R. RAND SAMPLE
- B-15 GROUND LOCATION POINT

NOTE: TRENCH B PHOTOS ARE PREFIXED "B-" IN APPENDIX B.

MAINE NUCLEAR POWER STATION  
 PHOTO AND SAMPLE LOCATIONS  
 TRENCH B  
 SEARS ISLAND SEARSPORT, MAINE

**FIGURE 9**

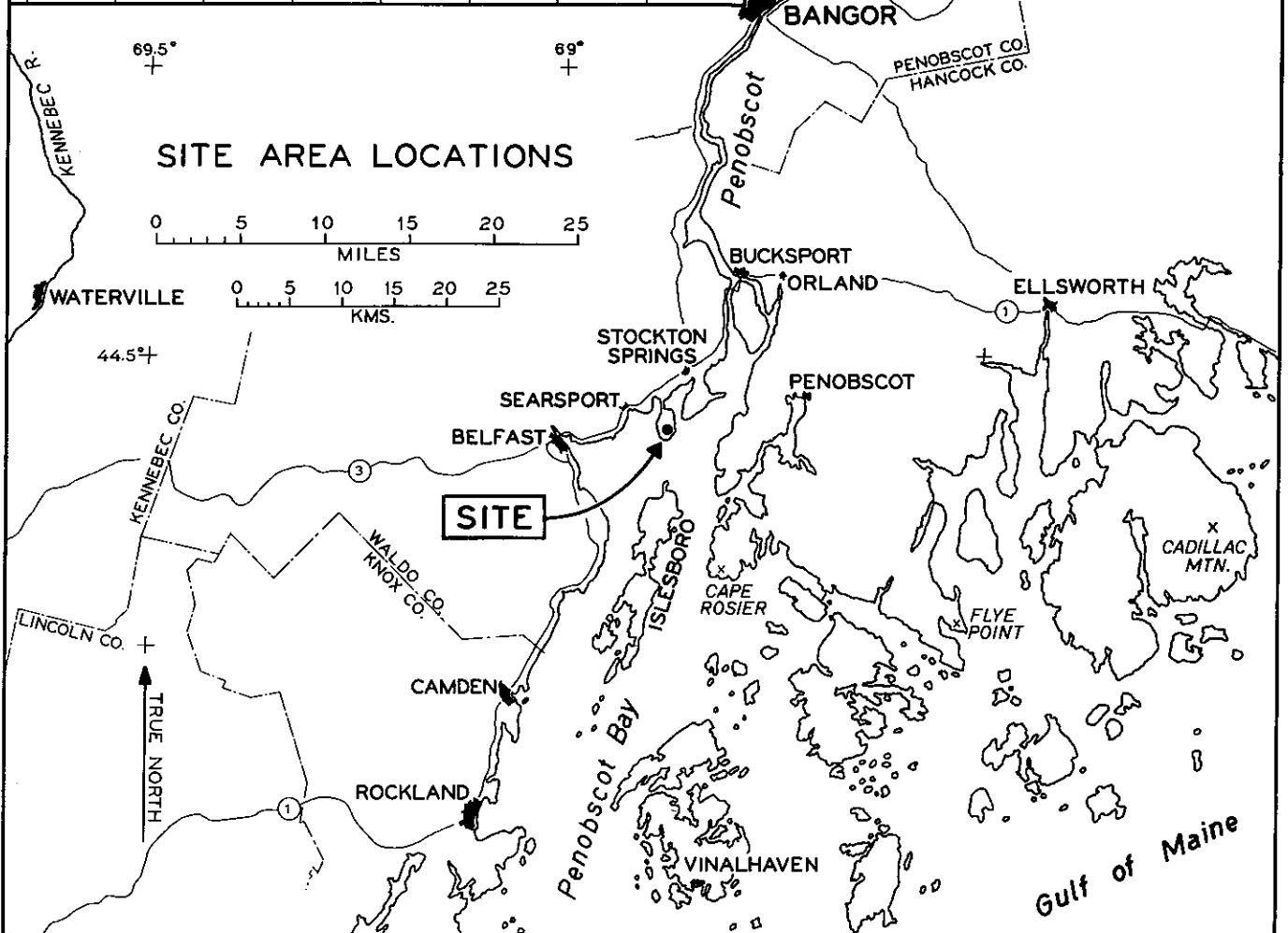


**FIGURE 10**

**REGIONAL LOCATION MAP**

MAINE NUCLEAR POWER STATION  
SEARS ISLAND SEARSPORT, MAINE

JOHN R. RAND APRIL 1, 1976



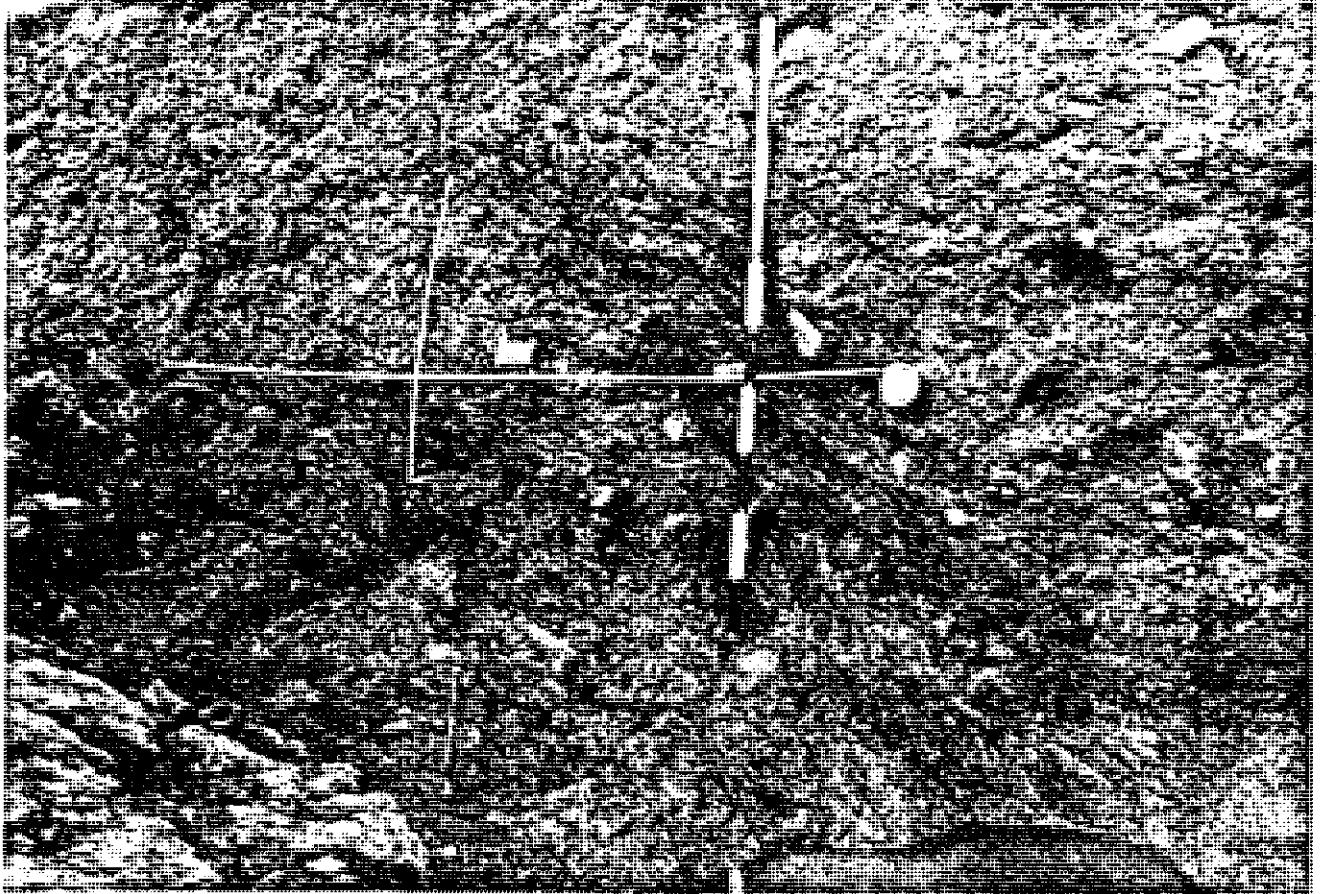
## APPENDIX A

### Photos of Trench A Contents

<u>Photo #</u>	<u>Description</u>	<u>Page</u>
A-1	East Wall: F-1 and "Rust" Zone	A-1a
A-2	East Wall: Close-up of F-1	A-2
A-3	East Wall: Close-up of "Rust" Zone just above F-1	A-3a
A-4	East Wall: Till/Bedrock Interface	A-4
A-5	East Wall: Looking Northeast Along Trench	A-5
A-6	West Wall: Close-up of F-2	A-6
A-7	Looking West at Point 11	A-7
A-8	Close-up of Point 11	A-8
A-9	Looking East at F-3	A-9
A-10	Close-up of F-3	A-10
A-11	Looking West at F-4	A-11
A-12	West Wall of Rock Excavation	A-12a
A-13	West Wall of Rock Excavation: "Gouge" Zone and Fault Plane	A-13a
A-14	West Wall of Rock Excavation: Offset Quartz Mass	A-14a
A-15	East Wall of Rock Excavation: Fault Plane at South End	A-15
A-16	Looking West at "Cracking" Pattern in Till above F-4	A-16
A-17	Looking East at "Rust" Zone above F-3	A-17
A-18	East Wall: "Rust" Zone and Till Oxidation Pattern above F-1	A-18
A-19	East Wall: "Rust" Zone in Till above F-1	A-19
A-20	East Wall: Close-up of GEI Sample Location above F-1	A-20
A-21	Appearance of "Rusty" Crack from GEI Sample above F-1	A-21
A-22	Far East Wall: Limonite Stained Band North of "gouge" zone	A-22
A-23	Color Photo of Limonite Stained Band	A-23
A-24	Black & White Close-up of Limonite Stained Band	A-24
A-25	Far West Wall: "interfingered" Oxidation Pattern in Lodgment Till	A-25
A-26	Far West Wall: Oxidation Pattern in Till	A-26

<u>Photo #</u>	<u>Description</u>	<u>Page</u>
A-27	Far West Wall: Lodgment Till and Ablation Till/ Outwash Contacts	A-27
A-28	Far West Wall: Outwash	A-28
A-29	Rotation Shear Test on "Gouge"	A-29
A-30	5000X Photo of "Gouge"	A-30
A-31	5000X Photo of Main Laurentide Lodgment Till	A-31
A-32	80X Thin Section P-3, Quartz Texture in Phyllite	A-32
A-33	80X Thin Section G-1F, Phyllite Fragment from "Gouge"	A-33
A-34	28X Thin Section APH-1, Quartz Grains in "Gouge"	A-34
A-35	28X Thin Section APH-1, Same as A-34 but with crossed Polar Light	A-35
A-36	200X Thin Section APH-1, Muscovite Grain in "Gouge"	A-36
A-37	28X Thin Section G-46, Phyllite Fragment from "Gouge"	A-37
A-38	28X Thin Section G-26, Quartz Grains from "Gouge"	A-38
A-39	80X Thin Section APH-1, Quartz Vein in "Gouge"	A-39
A-40	28X Thin Section APH-1, Foliation in "Gouge"	A-40
A-41	28X Thin Section S10E, Foliation in Phyllite	A-41
A-42	28X Thin Section P-3, Foliation in Phyllite with Interbedded Metasiltstone	A-42

PHOTO A-1 - Trench A, Nail F-1. Original east wall, view looking toward the northeast. Scale 1" = Approx. 3'

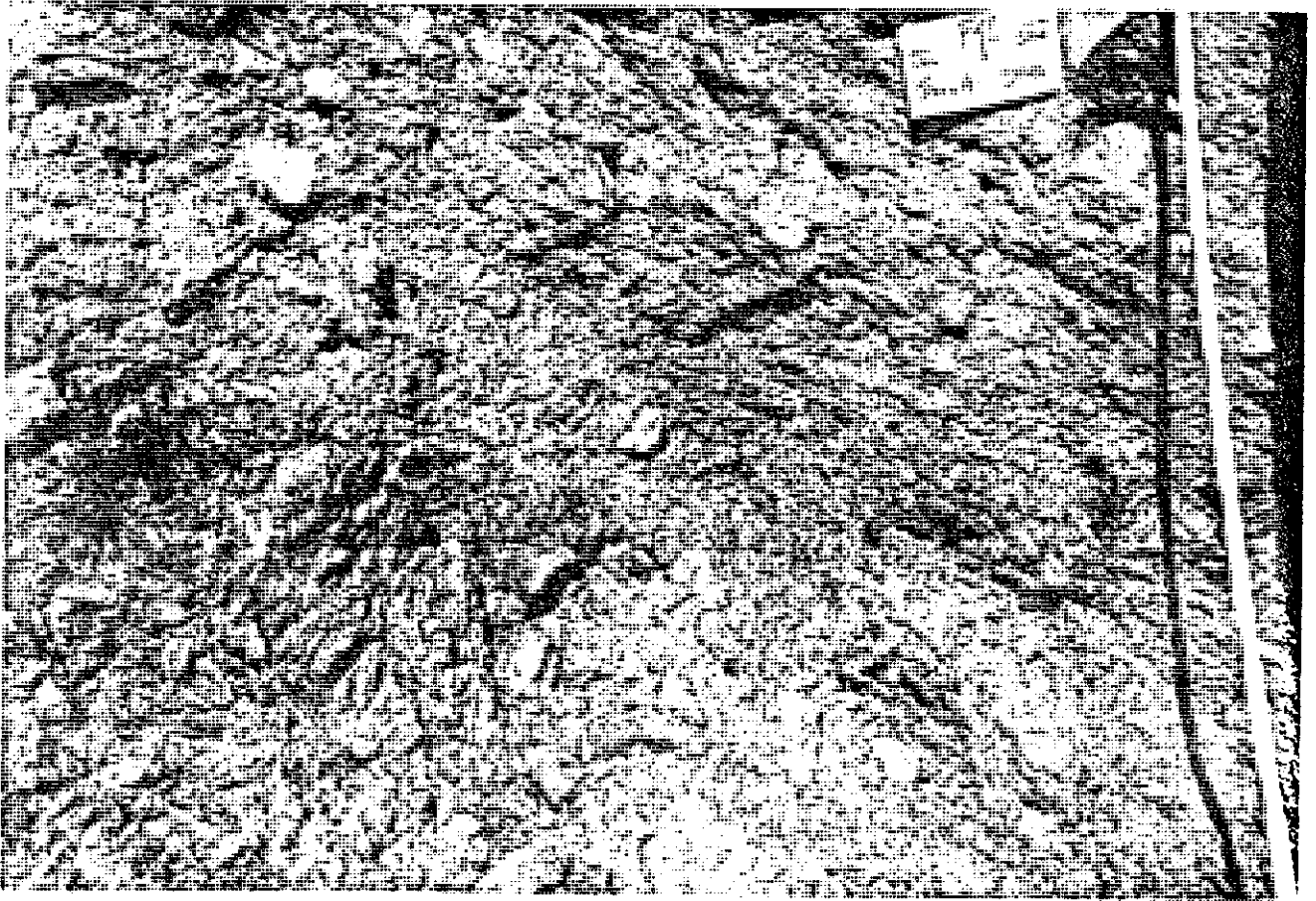


The dark bluish-gray zone in the lower part of the photo is weathered phyllite bedrock. The medium grayish-brown with disseminated light gray pebbles and cobbles in the upper part of the photo is Wisconsinan (Laurentide) lodgment till estimated at 22,000 to 16,000 years old. The somewhat "smooth" looking medium blue band which dips to the southeast from the 2' mark on the range pole is soft, plastic extremely-weathered phyllite ("gouge") which has intruded about 6" up into the till at this location. A rusty crack rises to the northwest from the "gouge" zone for about 6' in the till. The till to the northwest of this crack exhibits a somewhat "hackly" surface texture, while that to the southeast of the crack is fairly smooth. The bedrock surface in detail is relatively rough, without evidence of glacial scouring. Although the structure within the bedrock has been extensively deformed from its normal foliation fabric, there is no evidence of rupture of the till/bedrock surface at any location other

than at the "gouge" intrusion.

The upward projection of the northern bedrock fault exposed in the subsequently-excavated rock cut here would theoretically intersect the till/bedrock contact below the yellow tag on the left.

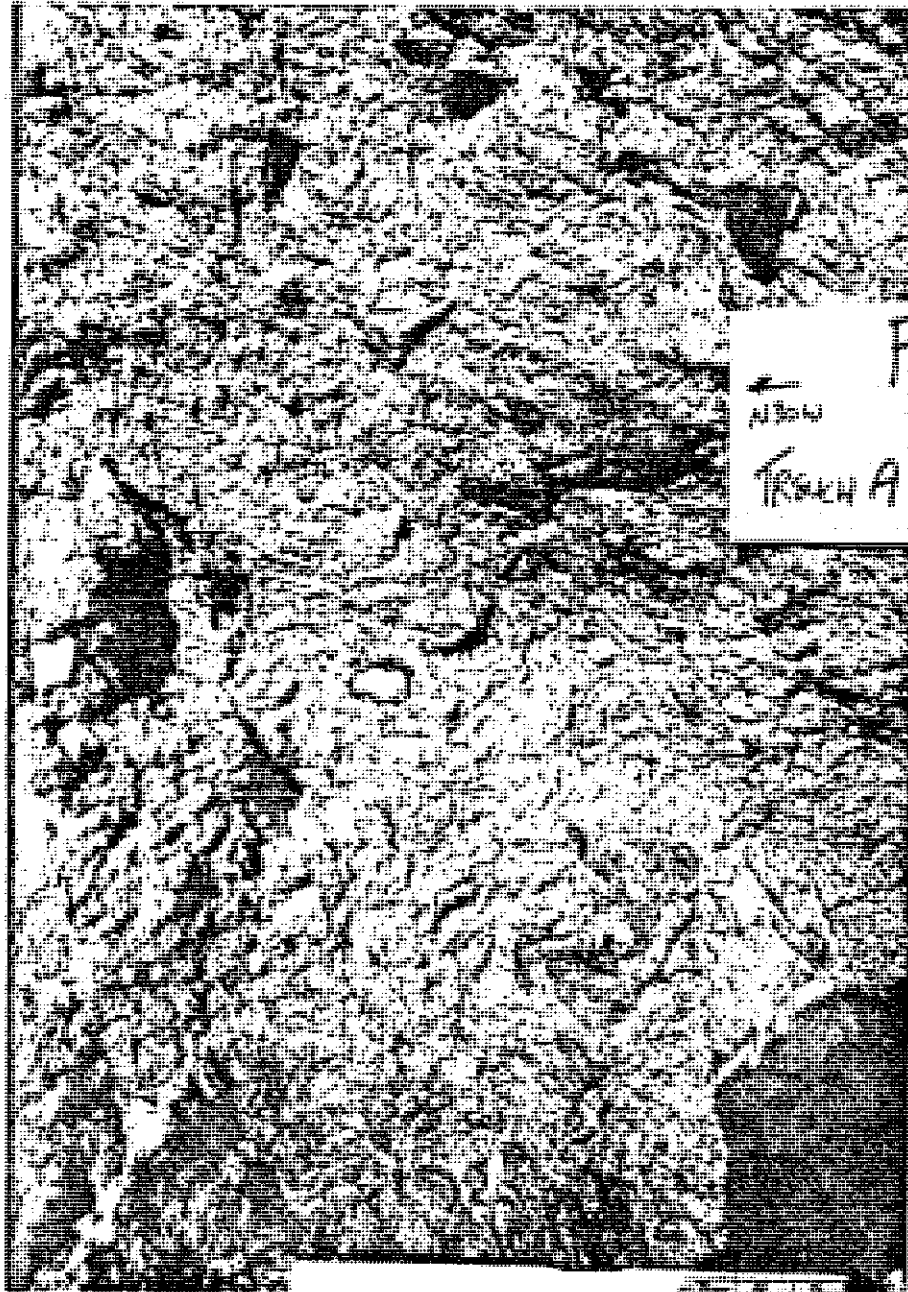
PHOTO A-2 - Trench A, Nail F-1. Original east wall, view looking toward northeast. Scale 1" = Approx. 9".



The plastic phyllite "gouge" zone is the 6"-wide medium blue band which dips to the lower right corner of the photo from just to the right of the triangular quartz pebble in the center of the photo. The triangular quartz pebble is in a till matrix. To the right of the triangular pebble, the "gouge" has intruded the till by about 6". The rusty crack in the till rises to the northwest from the footwall plane of the "gouge" zone toward the upper left corner of the photo. A tight southeast-plunging rusty fold in till occurs in the footwall of the main rusty crack about 9" up-dip from the triangular quartz pebble. The surface texture of the till to the northwest of the main rusty crack appears hackly and somewhat fissile, while that to the southeast of the crack is smooth. The bedrock structure throughout is highly deformed.



PHOTO A-3 - Trench A, Nail F-1. Original east wall, looking toward northeast. Scale 1" = Approx. 4".

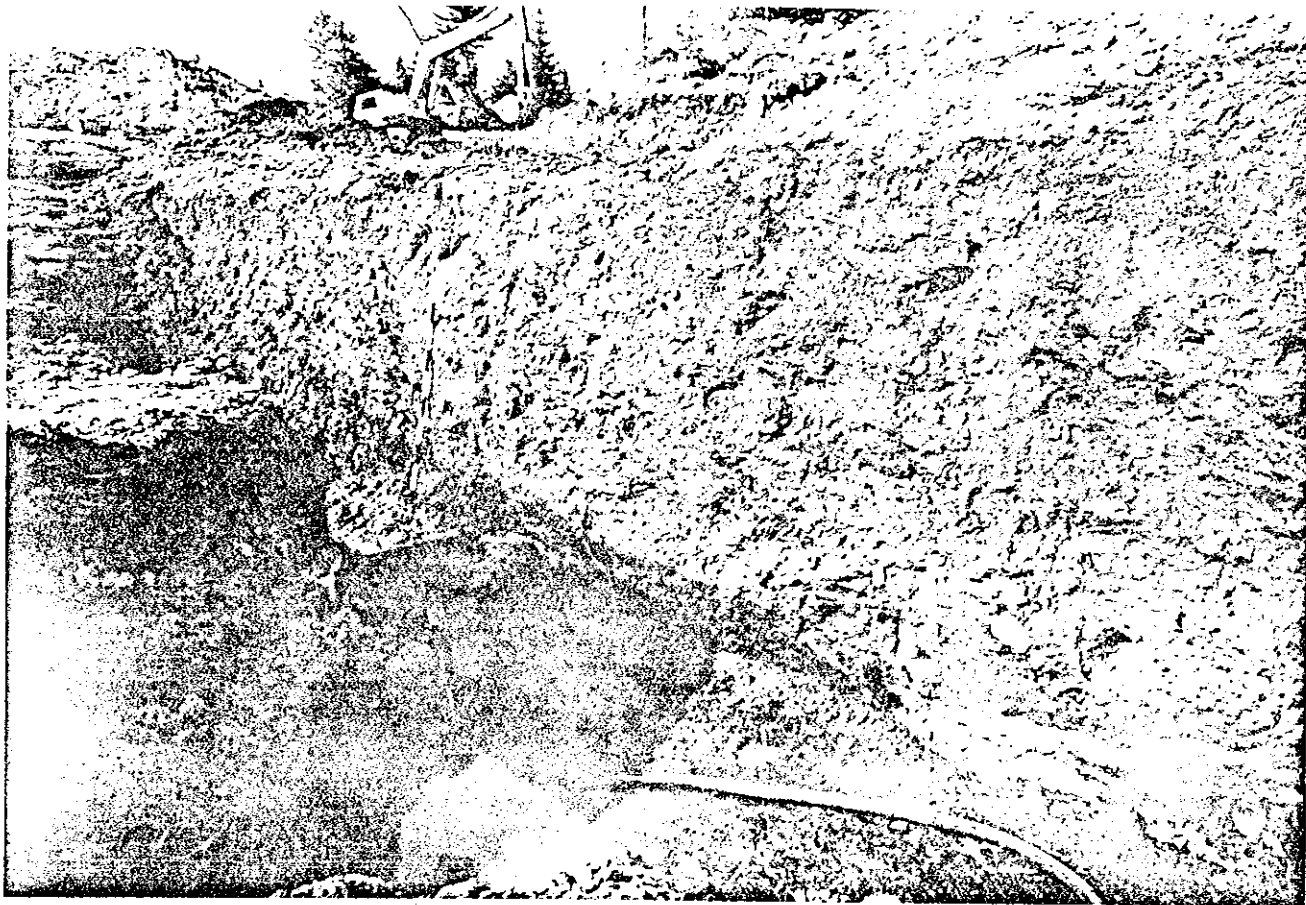


Detail of deformation at Nail F-1. The triangular quartz pebble of Photo A-2 is at the edge of the shadow, about 1" above the lower right corner. The irregular bedrock surface slopes gently to the right about 1" above the bottom border of the photo. The phyllite "gouge" is the speckled gray area which extends about 3/4 inches on the photo above the upper right edge of the quartz pebble. The rusty crack (which is not rusty along the footwall of the "gouge" zone) extends up to the left across the photo from

the top of the quartz pebble to about an inch below the upper left corner of the photo. Pronounced fold deformation in the footwall block of the till to the left (northwest) of the rusty crack is not mirrored or otherwise in evidence in the hangingwall block.

PHOTO A-4 - Trench A, original east wall, looking toward the north.

Scale: 10-foot range pole painted in 1-foot increments.



The bedrock surface is displayed as a gently-curving boundary between grayish-brown Laurentide lodgment till above and very dark gray, weathered phyllite bedrock below. The plastic phyllite "gouge" intrusion at Nail F-1 is at the 3-foot elevation of the range pole, about 1' below the yellow tag. While the bedrock surface is somewhat irregular in detail, the curving trace of the bedrock surface averages as a "smooth" through-going boundary which does not exhibit fault offset. The whitish material in the bedrock near the lower right corner of the photo is an isolated block of severely-weathered felsic dike material which has been compressed downward and dragged out to the southeast by glacial loading and transport. Normally hard, unweathered bedrock forms the elevated floor of the trench near the upper left corner of the photo.

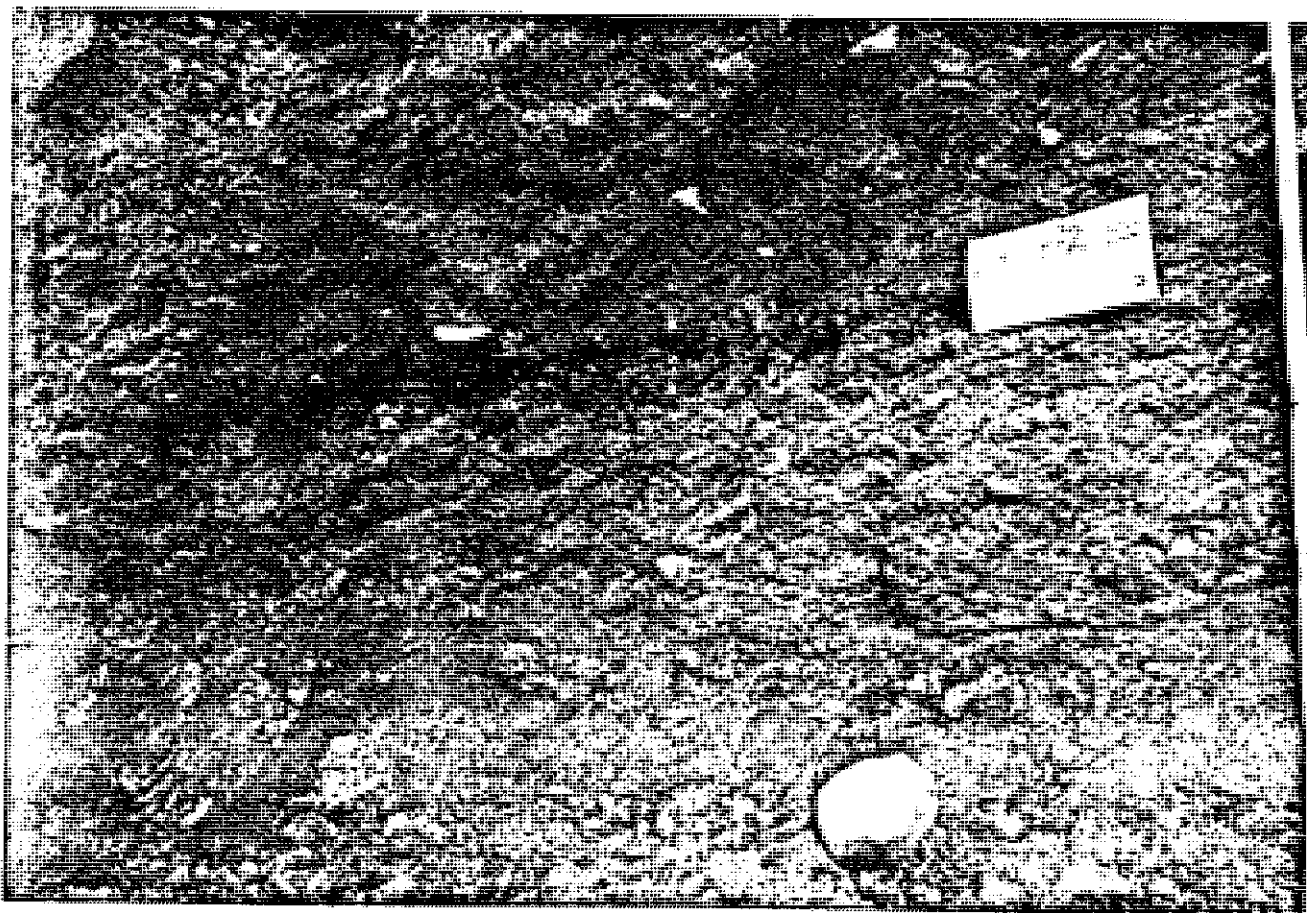
PHOTO A-5 - Trench A, original east wall, looking north.

Scale: 10-foot range pole, as in Photo A-4.



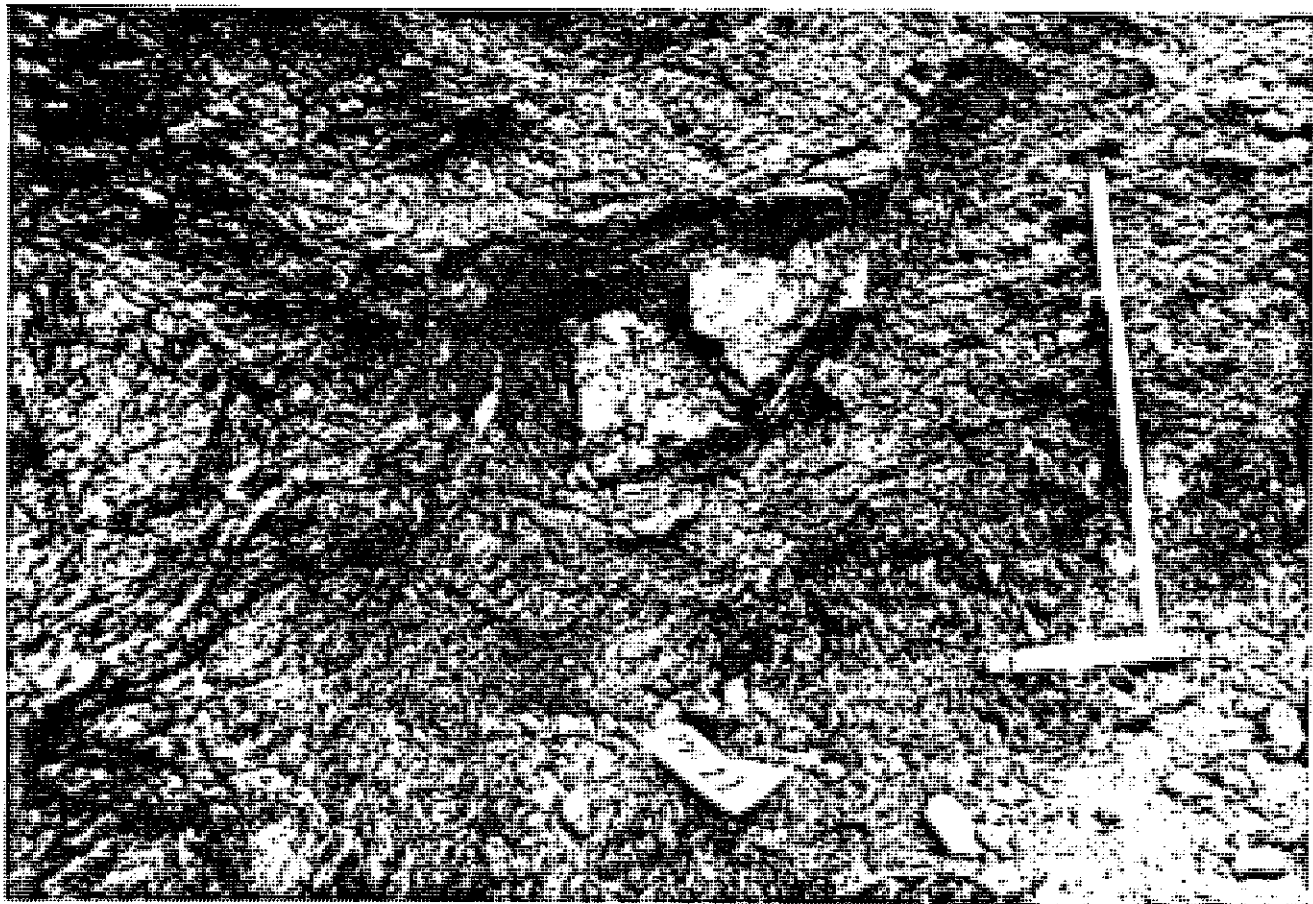
A more long-distance view of the bedrock surface than Photo A-4, taken from near the south end of the trench. The plastic phyllite "gouge" intrusion is at the range pole. The depressed block of soft felsic dike material is near the center of the photo. The gently-curving trace of the till/bedrock surface shows no fault offset of bedrock blocks at the "gouge" intrusion.

PHOTO A-6 - Trench A, Nail F-2. Original west wall of trench, about 10' S34W of Nail F-1, view looking toward southwest. Scale 1" = Approx. 7".



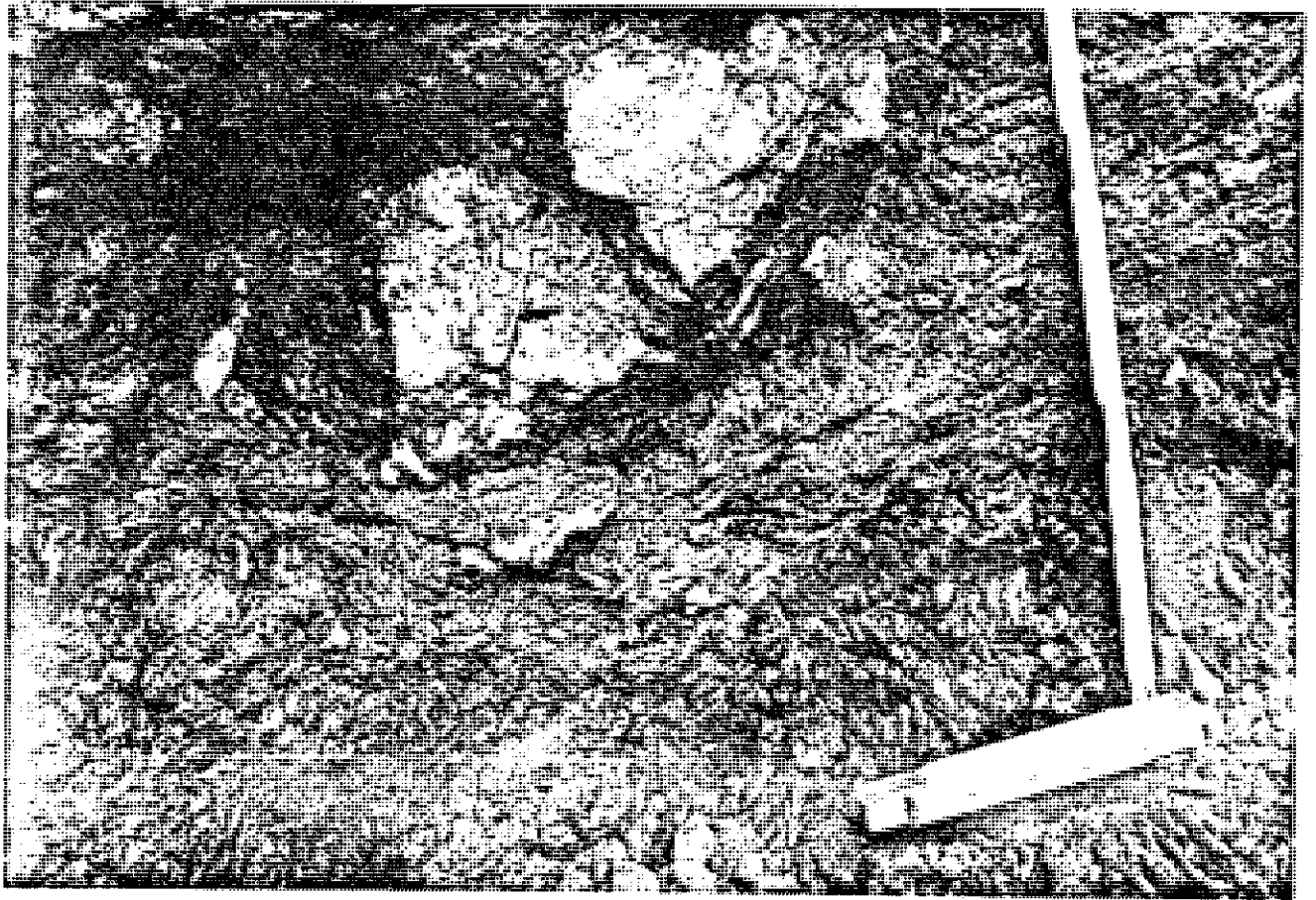
The dark bluish zone at the bottom  $1\frac{1}{2}$ " of the photo is weathered phyllite bedrock. The medium bluish-green above is Laurentide lodgment till. The till/bedrock contact slopes gently to the left (southeast) from the right edge of the photo for  $3\frac{1}{2}$ " on the photo, at which point it steps up by about 3" true displacement on a moderately-steeply southeast-dipping crack, and then continues as a somewhat irregular surface off the photo to the left. The bedrock material just on the hangingwall (southeast) side of the step-up is "gouge". A crack rises to the northwest from the "gouge" intrusion toward the upper right corner of the photo, where it becomes rust-stained. The till exhibits a gently southeast-dipping fissility in the footwall block to the right (northwest) of the crack, and is essentially massive in the hangingwall block to the left (southeast).

PHOTO A-7 - Trench A, Point 11. About 25' S34W of Nail F-2, looking toward the southwest. Scale 1" = Approx. 7".



The bedrock surface forms a pronounced curve, concave upward, which enters the right side of the photo about 1.1" below the upper right corner, slopes down to the left (southeast) to a point about 1½" above the lower photo border at its center, and then rises to leave the photo about 1¼" below the upper left corner. The bluish band which rises up to the right (northwest) from the red pin (at the yellow "Pt.11" tag) is phyllite "gouge". The "gouge" dies out against till under the right side of the prominent quartz boulder in the center of the photo. The bedrock to the right (northwest) of the "gouge" zone (bluish) is weathered and deformed, while that to the left (southeast, brown-tinged) is little weathered and relatively hard.

PHOTO A-8 - Trench A, Point 11. Looking to the southwest, close-up view of Photo A-7. Scale 1" = Approx. 4".

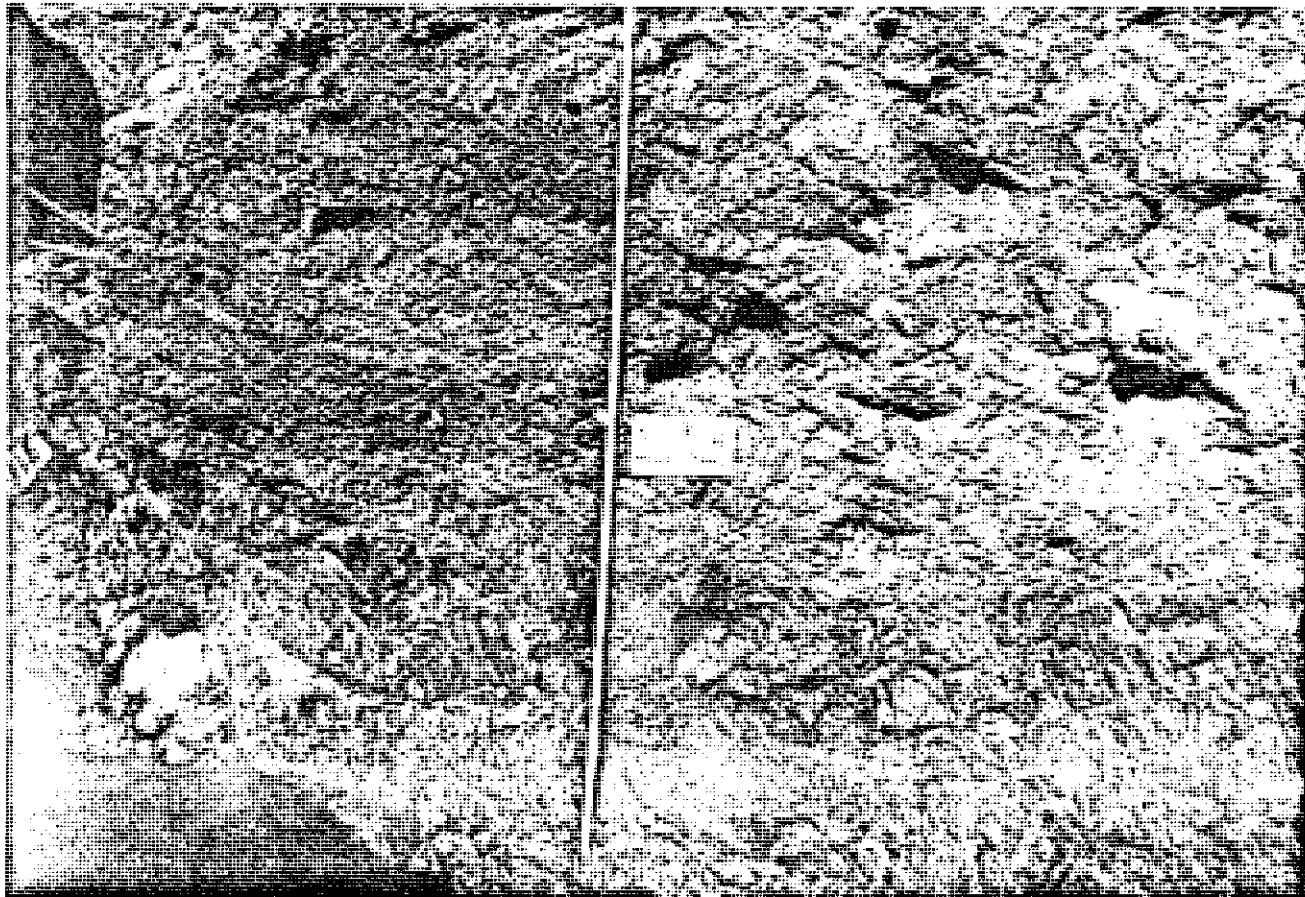


The "gouge" zone is the medium blue band which rises to the right (northwest) and dies out against till under the right edge of the large quartz boulder. Above the "gouge" the fissility in the till is gently folded. A unit of thinly-laminated silt which exhibits a greenish tinge in the photo enters the left border of the photo at its center and trends almost horizontally to divide around a quartz chip near the center of the photo. The silt unit, which is transected by the "gouge" intrusion just to the right of the quartz chip, re-appears on the right side of the "gouge" without apparent vertical offset, and rises up to the right (northwest) along the bedrock surface. Just below the quartz chip the "gouge" is seen to have intruded to the left into a re-entrant between the greenish silt unit and the hard brownish bedrock mass.



PHOTO A-9 - Trench A, Nail F-3. Looking toward the northeast.

Scale 1" = Approx. 16".



The somewhat irregular bedrock surface trends across the photo from 1.6" above the lower right corner of the photo to about 3" up from the lower left corner. The bluish-gray band of plastic phyllite "gouge" rises steeply to the northwest (left) from immediately to the right of the base of the folding rule, and extends upward into the till for about 6" (true). A crack in the till rises and curves to the northwest from the footwall of the "gouge" intrusion, with rusty staining extending outward from the crack along planes of fissility in both the hangingwall and footwall blocks of till. "Gouge" sample "A-F3", with a radiometric (K-Ar) age of  $270 \pm 10$  million years, was taken from immediately to the right (southeast) of the base of the folding rule.



PHOTO A-10 - Trench A, Nail F-3. Looking toward the northeast.

Scale 1" = Approx. 6".



Closer view of Photo A-9. The "gouge" zones rises steeply up to the left (northwest) from the point where the folding rule meets the lower border of the photo. Where it intrudes the overlying till, the fissility in the till is arched upward, and "gouge" has intruded to the right (south-east) between till and a hard, somewhat rusty block of bedrock. A medium-light gray laminated silt unit enters the right edge of the photo about 1.1" above the lower right corner and slopes irregularly down to the left (northwest) to be transected by the "gouge" at a point 2.1" to the left of the right border and 0.7" up from the lower border of the photo. This gray silt unit re-appears without apparent vertical offset to the left (northwest) of the "gouge" zone and slopes irregularly up to the left to exit the photo about 2" below the upper left corner.

PHOTO A-11 - Trench A, Nail F-4. Looking toward the southwest.

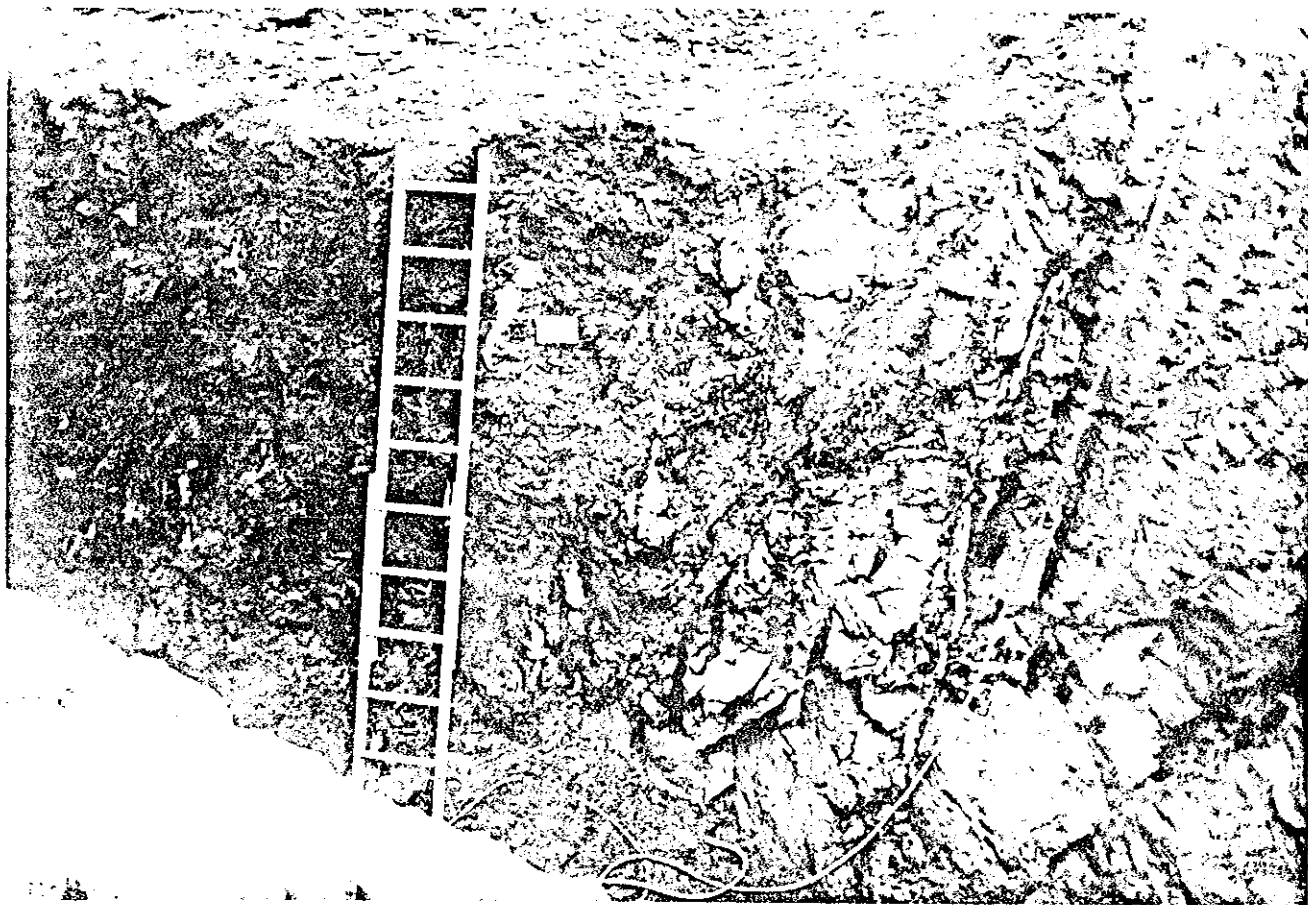
Scale 1" = Approx. 12".



The phyllite "gouge" zone is very thin at this location and occurs in the wedge between hard bedrock (medium-blue) in the lower right (northwest) corner of the photo and grayish-blue till, at a point about 1.6" to the left of the right border and 0.7" up from the bottom border of the photo. The irregular weathered bedrock surface slopes down to the right (northwest) from the left border of the photo, about 1.2" up from the lower left corner. The "gouge" zone dips at about  $70^{\circ}$  to the southeast, and is well foliated parallel to dip, with no drag textures suggestive of high-angle reverse fault displacement of the southeast block over the northwest block. The depression of the weathered bedrock surface just to the southeast (left) of the "gouge" zone is suggestive of loading from above, downward from the northwest. The hard (brownish) bedrock surface below the folded yellow flag, 1.4" to the left of the right border and 0.7" up from the lower border, exhibits striations which plunge about  $85^{\circ}$  to the southwest.

PHOTO A-12 - Trench A, Southwest Wall of Rock Cut. Looking southwest.

Scale 1" = Approx. 3'.



The lighter-blue area between the ladder and the green garden hose shows the relationship between the northern bedrock fault plane and the "gouge" zone (Refer to "Rock Cut" profile, Fig. 4). The bedrock fault plane dips  $66^{\circ}$  to the southeast (left) from a point on the photo 1" below the top border and 1.7" to the left of the right border, and goes into the floor of the cut at a point 1" up from the lower border and 3.6" to the left of the right border. The "gouge" zone parallels the northern fault plane, and lies on a second fault which trends up to the right (northwest) behind the third rung up from the bottom of the ladder. Steep north-dipping quartz lenses lie between the "gouge" and the northern fault plane, and an angular mass of felsic dike material (light blue-gray) lies on the northern fault plane 2.5" left of the right border and 1.2" below the top border of the photo. The bedrock to the right

(northwest) of the northern fault plane is fresh and hard; that to the left (southeast) is weathered and relatively loose. The quartz lens immediately between the ladder and the rectangular white tag has been laterally offset toward the "gouge" zone on successive low-angle overthrusts directed from the southeast toward the northwest.

PHOTO A-13 - Trench A, Southwest Wall of Rock Cut. Looking southwest.

Scale: Range pole is painted in 1-foot increments.



Detail of the northern bedrock fault and "gouge" zone. The northern fault plane rises to the northwest (right) from a point on the lower border of the photo about 1.3" to the right of the lower left corner and exits at the upper right corner. The "gouge" zone rises parallel to the northern fault from a point about 2" above the lower left corner, and trends in back of the range pole between elevations 8-9'. The steep north-dipping attitude

of the quartz lenses between the northern and "gouge" fault planes suggests an originally normal (rather than reverse) sense of displacement on the bedrock fault zone. A wedge-shaped horse of felsic dike material (light bluish-gray) lies on the northern fault plane in the upper right corner of the photo. At the top of the range pole, hard (brown) bedrock has squeezed the "gouge" zone laterally toward the northwest (right).

PHOTO A-14 - Trench A, Southwest Wall of Rock Cut. Looking southwest.  
Scale 1" = Approx. 0.35'.



Detail of quartz mass just to the southeast of the "gouge" zone, showing low-angle shear offsets with overthrust displacements directed laterally from southeast to northwest. The "gouge" zone trends up to the right (northwest) under the rectangular "Trench A" tag. Apparent clockwise rotation of the uppermost quartz block in incompetent weathered

phyllite (blue) is interpreted to be due to drag of overlying hard (brown) bedrock mass as it overthrust to the northwest into the "gouge" zone (see Photo A-13).

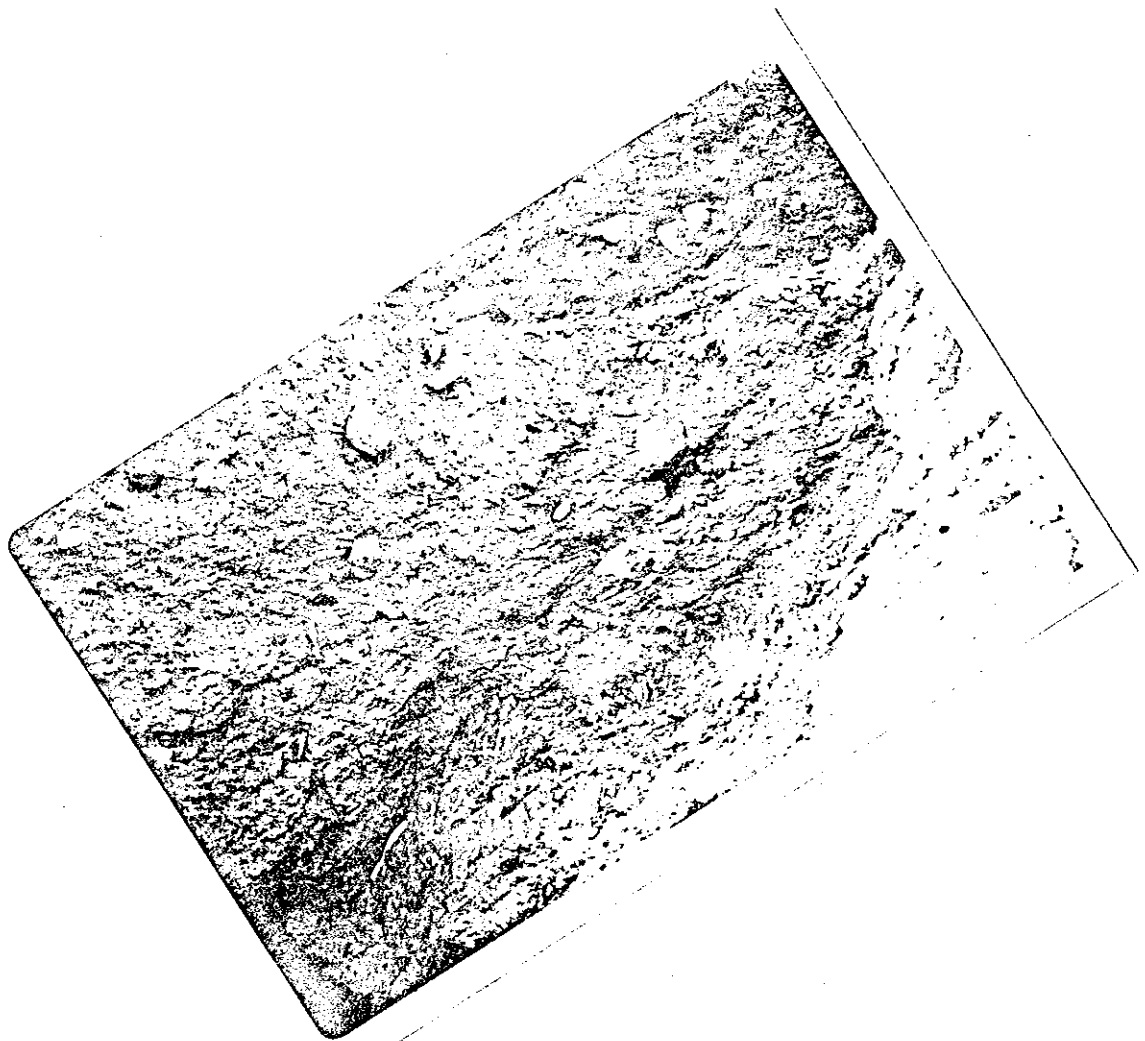


PHOTO A-15 - Trench A, East Overburden Wall and South End of Rock Cut.  
Looking northeast. Scale: Marker tags at 5-foot intervals.



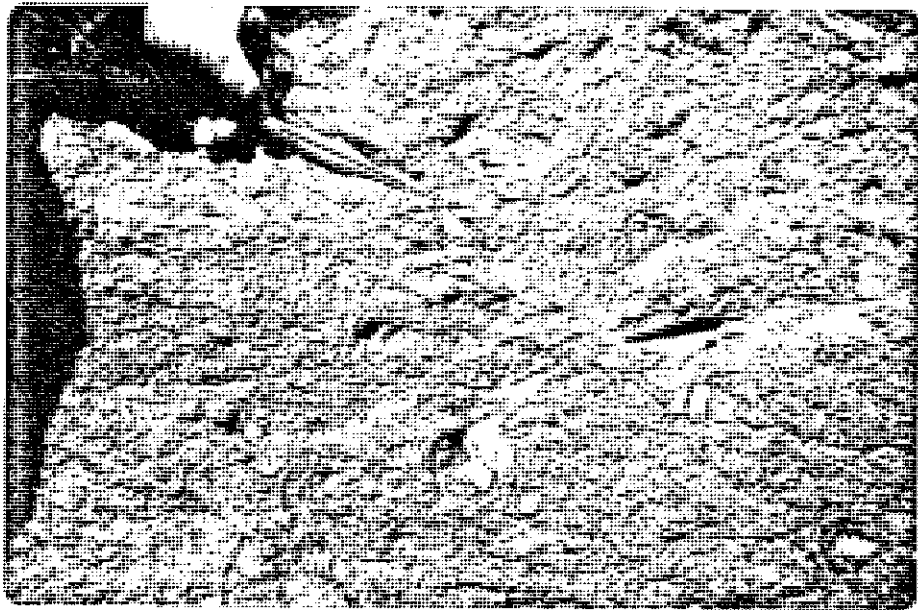
The thin white quartz veinlets rising from the lower right corner of the photo define the south bedrock fault plane of the Rock cut in Trench A. This fault rises toward, but does not offset or crack, the till/bedrock surface in the center of the photo. The irregular white mass in the left corner of the photo is an isolated mass of felsic dike material which has been dragged out toward the southeast (right) by subglacial transport.

PHOTO A-16 - Trench A, Above F-4. Far West Wall, view toward the southwest. Scale 1" = Approx. 2.5'.



Just above the ribbon in the bottom corner of the picture, two separate "cracks" appear to curve upward to the northwest from near a relatively fresh bedrock surface. These "cracks" cut across a zone of olive (oxidized) till and lead upward to the upper wall, however, they are not "rusty". These cracks could not be traced upward to the lodgement/ablation till contact.

PHOTO A-17 - Trench A, above F-3. East wall of small "pocket" trench.  
View toward the northeast. Scale 1" = Approx. 0.5'.



This small separate system of "rusty cracks" lies just to the southeast of the main "rusty crack" which cuts diagonally across the lower left hand corner of the picture. The "cracking" pattern seen in this picture generally follows the fissility and fabric of the main Laurentide lodgment till.

PHOTO A-18 - Trench A, above F-1. Original east wall, view toward the east. Scale 1" = Approx. 1.75'.



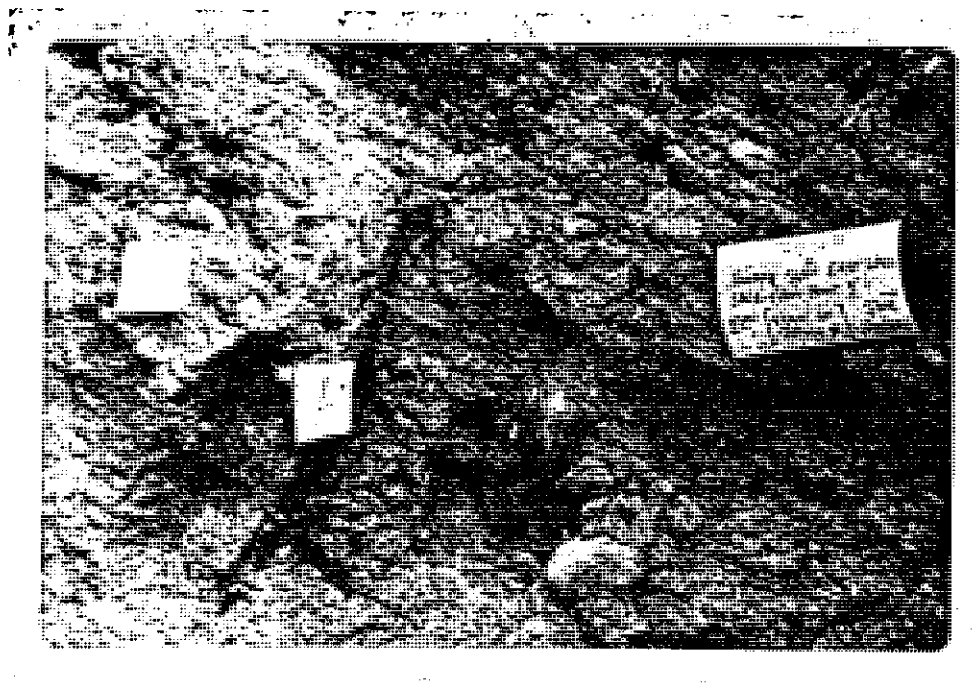
The bedrock/Laurentide till interface irregularly curves along the bottom of photo. The "gouge" zone is 1" from the lower right hand border of the photo. A "rusty crack" emanates diagonally upward and to the left then bifurcates about  $1\frac{1}{2}$ " from the right and 1" from the bottom border. Several "ladder" type horizontal cracks connect the two inclined "cracks" such as the one about 1" from the top border of the photo. Notice the till oxidation pattern  $\frac{1}{2}$ " from the top border near the center of the photo.

PHOTO A-19 - Trench A, above F-1. Original east wall, view toward the northeast. Scale 1" = Approx. 1½'.



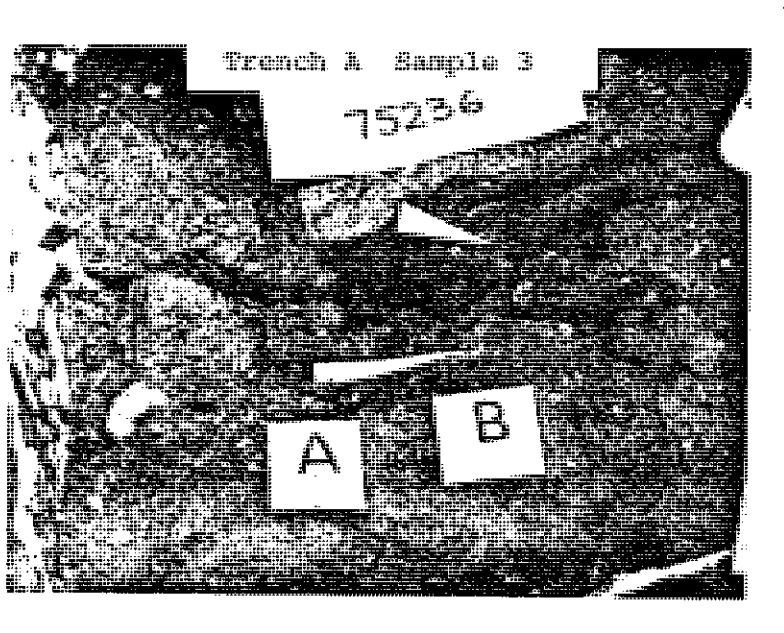
This is a closer view of the same "rusty cracks" in Photo A-18. In the right middle portion of the picture are the GEI sample blocks 1, 2 and 3. The bedrock/till contact is in the lower left hand corner. The lower of the two main "rusty cracks" runs from the lower right hand corner to the upper left hand corner.

PHOTO A-20 - Trench A, above F-1. Original east wall, view toward the northeast. Scale 1" = Approx. 0.9'.



The two main "rusty cracks" run diagonally across the left hand half of the photo. The white tags labeled "A" and "B" are on GEI sample blocks 1 and 2. The till fissility at this location is gently southeasterly dipping, not quite as steeply as the "cracks".

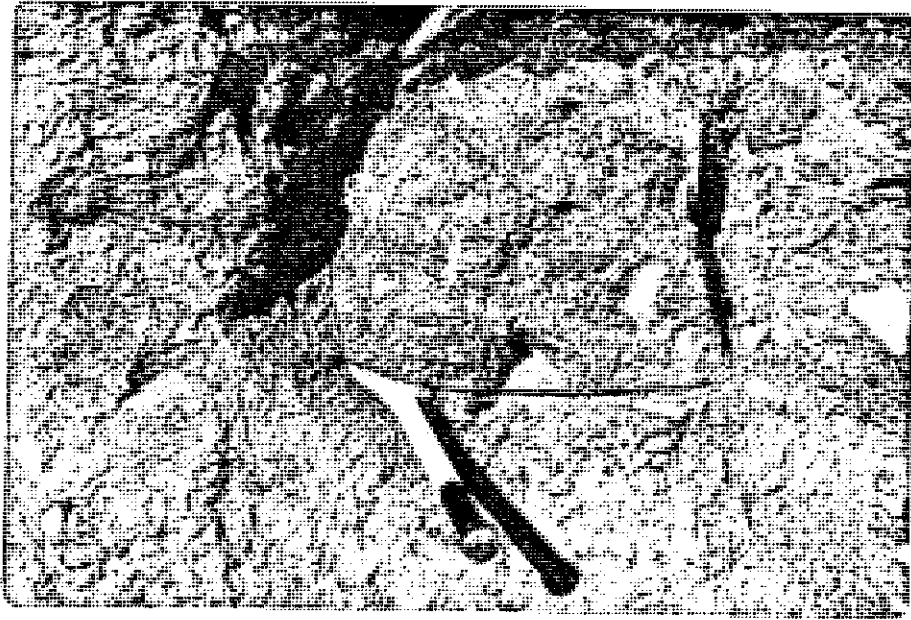
PHOTO A-21 - Trench A, from original east wall above F-1. View of  
"Rusty Crack" through Laurentide lodgment till.  
Scale 1" = Approx. 0.2'.



GEI oriented sample #3 across "rusty crack". Note the limonite staining on the till surfaces in the center of the photo. The stained surface is irregular and wavy here and does not resemble a shear plane.

PHOTO A-22 - Trench A, Far East Wall. View toward the northeast at a point northwest of the "gouge" zone.

Scale 1" = Approx. 2/3'.



A band of limonite staining runs from lower right to middle left portions of the photo, just below the chisel. GEI oriented sample #24 was taken here across the zone which is located about ten feet northwest of the "gouge" zone and three feet above the bedrock/till contact. This zone is not associated with the "rusty cracks" emanating from the "gouge", but instead, represents another type of oxidation staining in the Laurentide lodgment till.



PHOTO A-23 - Trench A, from Far East Wall. View of gray Laurentide  
lodgment till with band of limonite staining.  
Scale 1" = Approx. 0.2'.



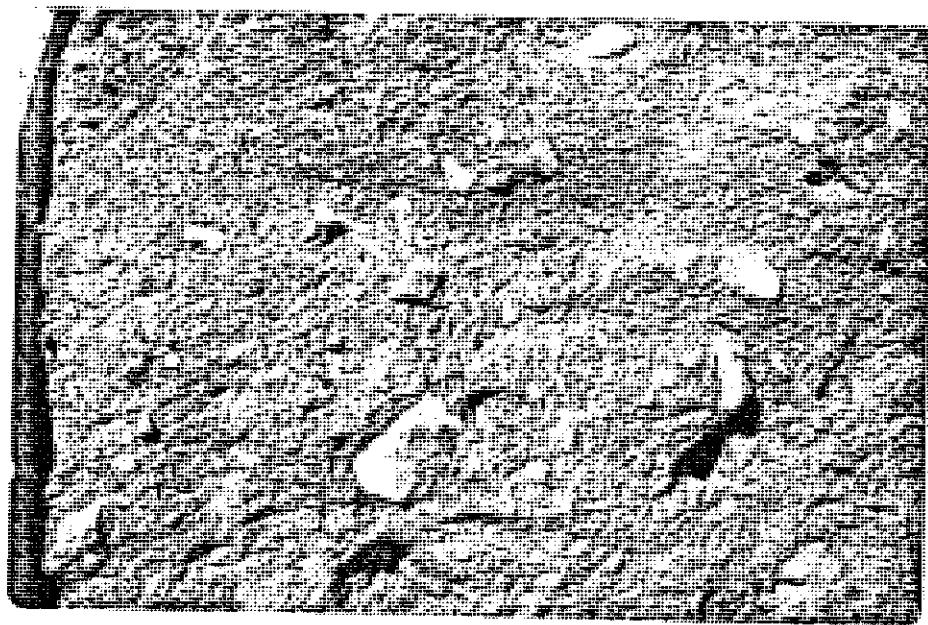
In GEI sample #24, the band of limonite staining runs from the upper right hand corner of the soil block to the left middle portion. In the upper right hand portion of the sample, an elongate piece of gravel has fallen out. This sample was taken from just above the chisel in Photo A-22.

PHOTO A-24 - Trench A, from Far East Wall. View of gray Laurentide  
lodgment till with band of limonite staining. Scale 1" = 1".



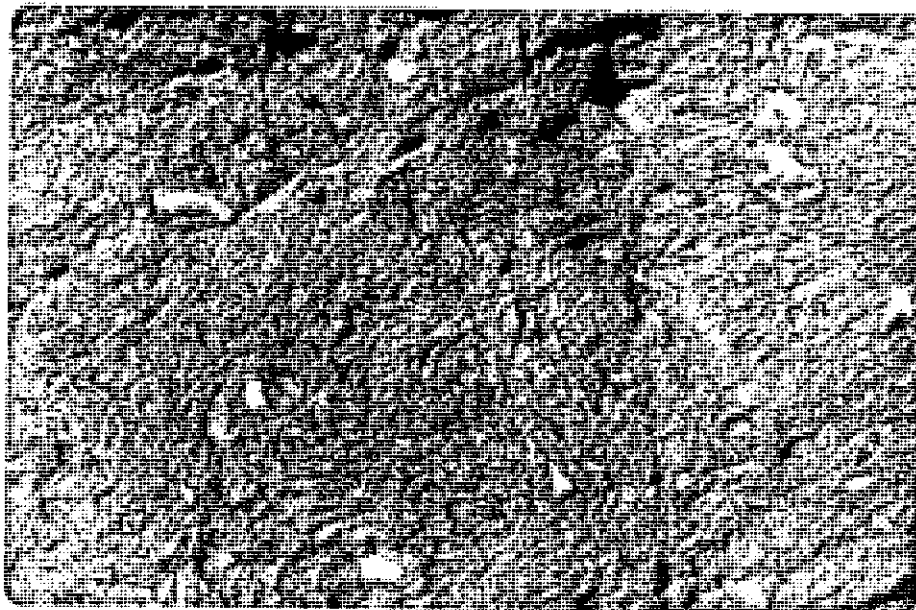
This is a black and white close-up view of GEI sample #24 from the location in Photo A-22 and also seen in Photo A-23. Note that the limonite staining is made up of a series of thin wavy, closely spaced parallel lines running from the upper right corner of the photo to the lower left corner. This is not the same type of limonite staining that occurs in the "rusty cracks" above the "gouge" zone.

PHOTO A-25 - Trench A, Far West Wall. View toward the southwest.  
Scale 1" = Approx. 1-2/3'.



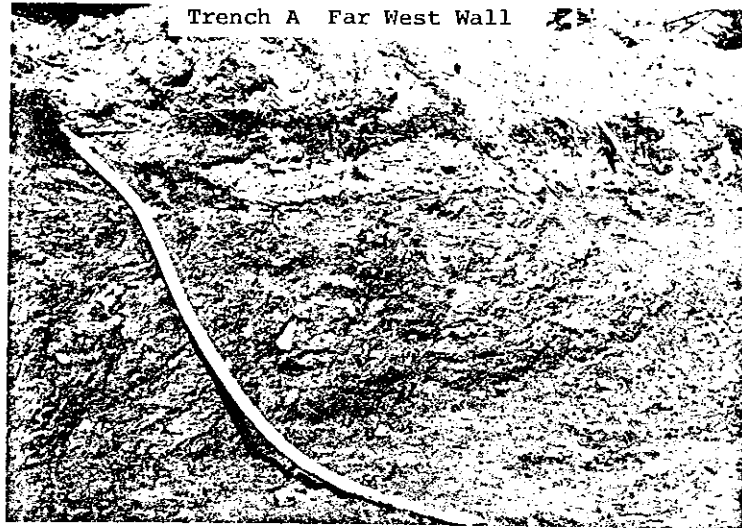
This photo illustrates the typical gray versus olive (brown) color pattern in the main Laurentide lodgment till. This location is to the northwest of bedrock fault planes in Trench A. The bedrock dips steeply to the southeast below the left hand corner of the photo. The olive (brown) till is identical to the gray till except that the olive till contains more iron oxide staining due to weathering of biotite. The oxidation pattern usually conforms to the till depositional fabric. The olive oxidized zones die out with depth from the surface and are usually non-existent below 15' or 20'.

PHOTO A-26 - Trench A, Far West Wall. View toward the southwest.  
Scale 1" = Approx. 0.8'.



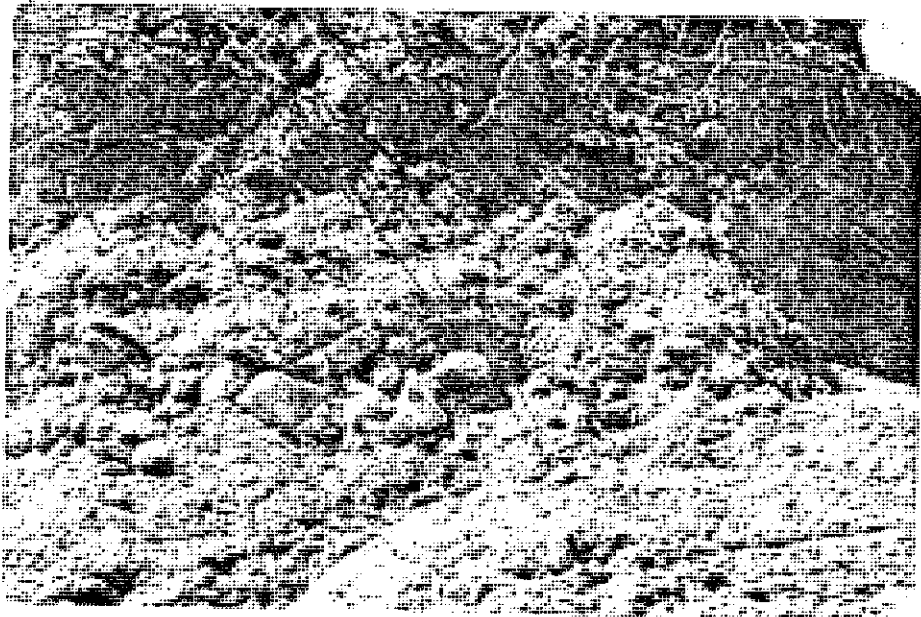
The olive (brown) versus gray color pattern in the Laurentide lodgment till is usually in a layered sequence as in Photo A-25. In this photo, however, the oxidation pattern in the gray till that creates the olive coloration is quite irregular and seems to be independent of fabric orientation. The location of this point is about 12 feet above the southwesterly extension of the bottom of the trough of Trench A.

PHOTO A-27 - Trench A, Far West Wall. View toward the west.  
Scale 1" = Approx. 4.5'.



Material excavated from the trench has been piled on top of the trench face. The original ground surface begins where the roots and branches begin to show. The lower unit is the dense Laurentide lodgment till showing the interfingered oxidation pattern of olive and gray till. Photo A-25 was taken just to the right of the middle section of the fire hose. Between the lodgment till and the loose spoil material dumped on top, there is an ablation till on the right half of the photo that grades into an outwash on the left half. Just to the left of the fire hose where it passes through the break in the outwash, a clump of unsorted lodgment-type till had been lodged in the outwash deposit.

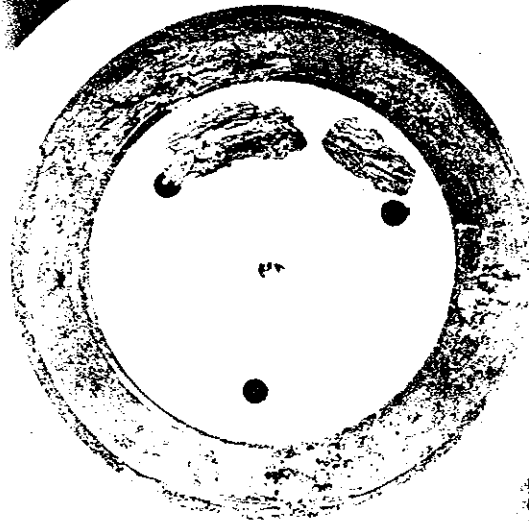
PHOTO A-28 - Trench A, Far West Wall. View toward the southwest.  
Scale 1" = Approx. 1'.



This photo was taken of the area just to the left of the location in the upper left portion of Photo A-27. Fissile dense Laurentide lodgment till lies along the bottom of the photo. The contact with the overlying outwash is about 3/4" up from the bottom of the photo. Notice the partial stratification and sorting of the outwash stratum with most of the coarse gravel and cobbles on the bottom. The rather smooth appearing indentation at the upper half of the photo on the right edge contained a clump of unsorted lodgment-type till that fell out before this photo was taken.

PHOTO A-29 - Rotation Shear Test on "gouge" from Far East Wall,  
Trench A      Scale 1" = 1.45"

PROJECT 75236      SAMPLE 26  
Rotational Shear      One Revolution  
 $\sigma_v = 19.9 \text{ kg/cm}^2$       June 26, 1975



Rotation shear tests on "gouge" samples were performed to determine the stress levels at which well-defined slickensides would be produced. Tests performed with vertical stress of less than  $8 \text{ kg/cm}^2$  failed to produce well-defined slickensides. This photo shows some well-defined slickensides after one revolution with a vertical confining stress of  $19.9 \text{ kg/cm}^2$ . Undisturbed samples of "gouge" removed from Trench A, then carefully dissected, failed to show slickensides. Lodgment till samples from Trench A were also subjected to rotation shear tests with  $\bar{\sigma}_v = 19.9 \text{ kg/cm}^2$  and there was only the slightest suggestion of slickensides being produced and then only on phyllite fragments. Undisturbed till samples taken from the field did not show any slickensides or any sign of shear displacement on the "rusty crack" zones.

PHOTO A-30 - Scanning Electron Microscope (SEM) Photograph of "gouge"  
in Sample 4 taken near Point F-1. Magnification of 5000X.



The surface shown is perpendicular to the foliation direction. The flaky-shaped particles with serrated edges may be graphite. Tests by Professor Gene Simmons at M.I.T. detected strong graphite peaks in GEI CM-13. Atomic Absorption Analysis on "gouge" Sample 26, also showed the presence of 5-10% carbon. After performing a rotation shear test with  $\bar{\sigma}_v = 19.9 \text{ kg/cm}^2$ , the "gouge" showed slickensides. (See Photo A-29)



PHOTO A-31 - Scanning Electron Microscope (SEM) Photograph of Laurentide lodgment till from GEI Sample 2 on the original east wall of Trench A. Magnification 5000X.



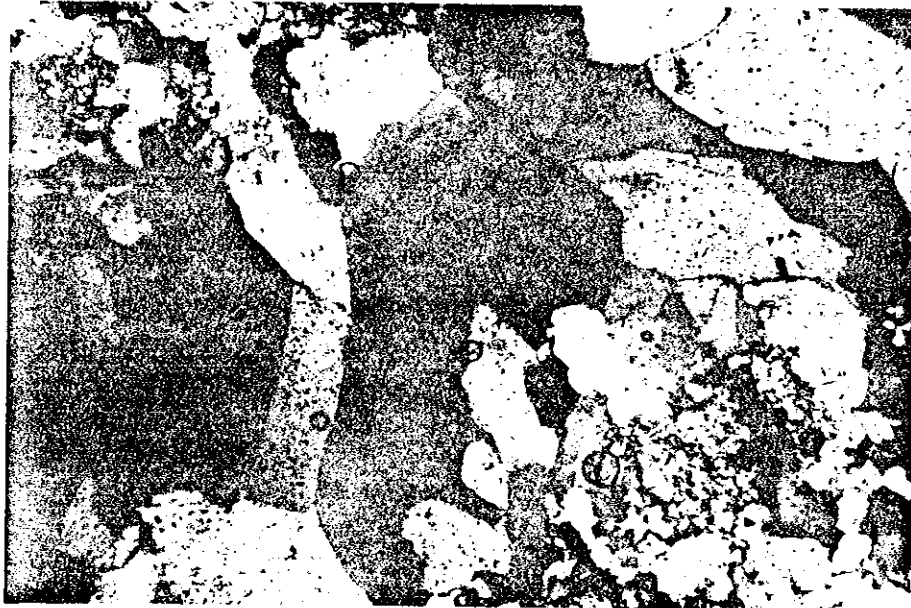
The original SEM photograph was taken at a magnification of 1500X looking down on the surface of till sheared in a direct shear box (Direct Shear Test DS-2). No consistent alignment of the particles was obvious. Note the angular and bulky appearance of the particles versus the "flaky" appearance of the "gouge" in Photo A-30. The till particles are primarily quartz and feldspar; the "gouge" particles are primarily chlorite and graphite(?).

PHOTO A-32 Phyllite from an exposure 25 feet northeast of F-1 in  
Trench A. Thin section P-3, plane light, X80.



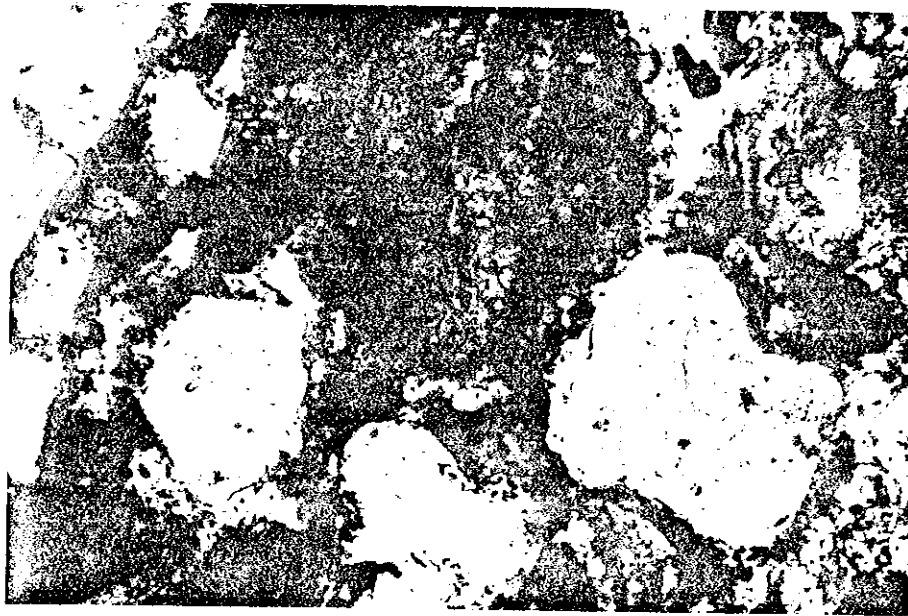
Typical texture of quartz in phyllite. Light areas are quartz,  
dark areas phyllite and pyrite.

PHOTO A-33 - "Gouge" adjacent to F-3 in Trench A. Thin section  
G-1F, plane light, X80.



Quartz grains in phyllite fragment from coarse fraction of  
soft gray "gouge". Fine grained areas at top left and bottom right  
are sericite. There is no textural evidence of cataclasis.

PHOTO A-34 - "Gouge" from original East Wall of Trench A adjacent  
to F-1. Thin section APH-1, plane light, X28.



Quartz grains in soft gray "gouge". Dark areas are pyrite and phyllite. The intact appearance of several of these grains suggests that no cataclasis has occurred.

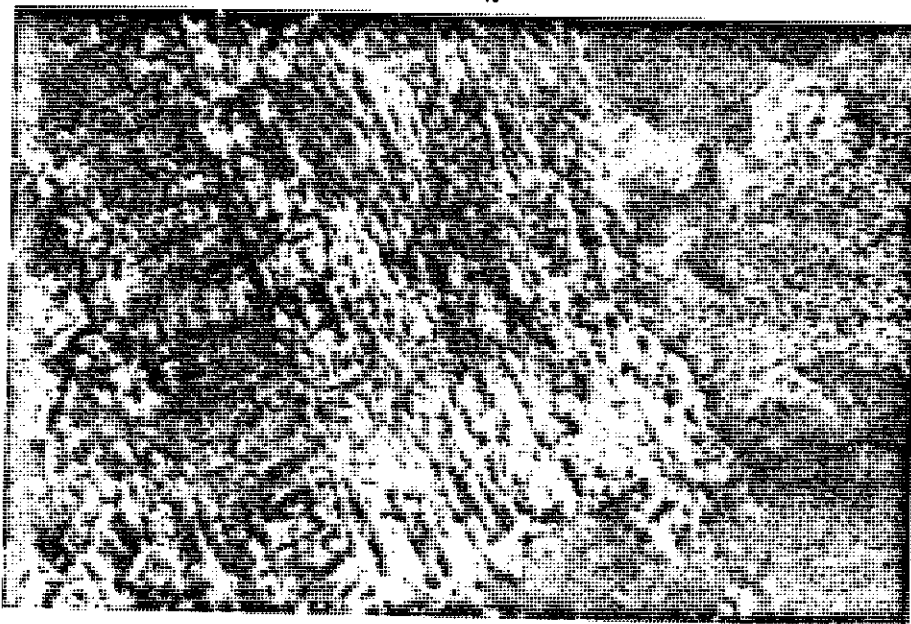
PHOTO A-35 - "Gouge" from Original East Wall of Trench A adjacent to F-1. Thin section APH-1, X28.

• DEC • 75



Same view as Photo A-34, but with crossed polars. The optical continuity of individual grains when viewed with crossed polars emphasizes their unsheared state.

PHOTO A-36 - "Gouge" from Original East Wall of Trench A adjacent  
to F-1. Thin section APH-1, X200.



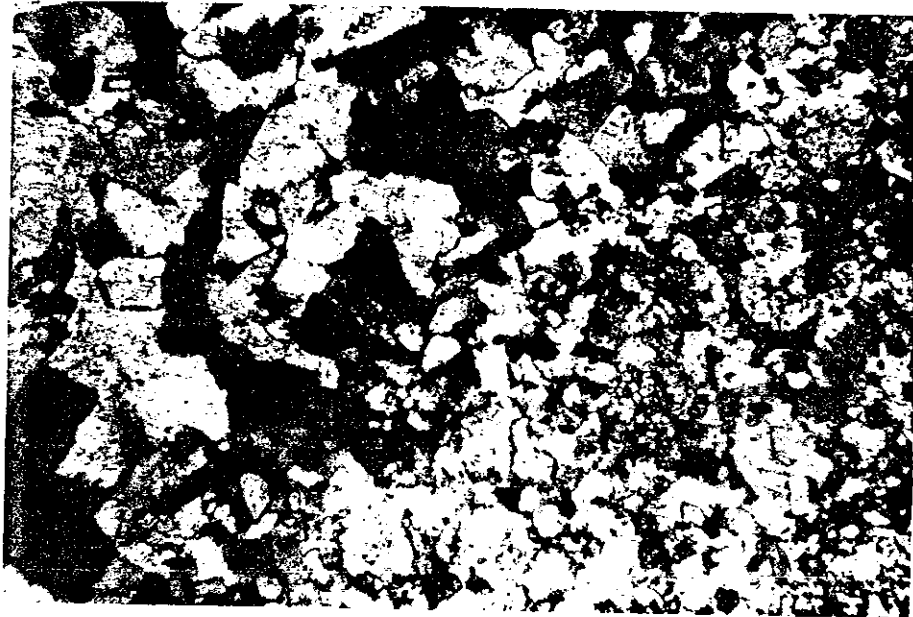
Muscovite grain in soft gray "gouge". Grain is unbroken, optically continuous, and shows no deformation suggestive of cataclasis.

PHOTO A-37 - "Gouge" from Original East Wall of Trench A, 6"  
northwest of F-1. Thin section G-4C, plane light, X28.



Portion of phyllite fragment from coarse fraction of soft gray "gouge". Crushed, strung-out appearance of quartz grains suggest shear under metamorphic conditions. No crystallographic alignment of quartz grains is present. Fabric is similar to that observed in phyllite samples.

PHOTO A-38 - "Gouge" from Trench A adjacent to F-3. Thin section  
G-2C, crossed polars, X28.



Quartz grains from fragment in coarse fraction of soft gray "gouge". The rather abrupt change of grain size and angularity of these grains suggests shear, but other textural details such as crushing, mortar structure and crystallographic alignment are absent.



PHOTO A-39 - "Gouge" from Original East Wall of Trench A adjacent  
to F-1. Thin section APH-1, plane light, X80.

• DEC • 75



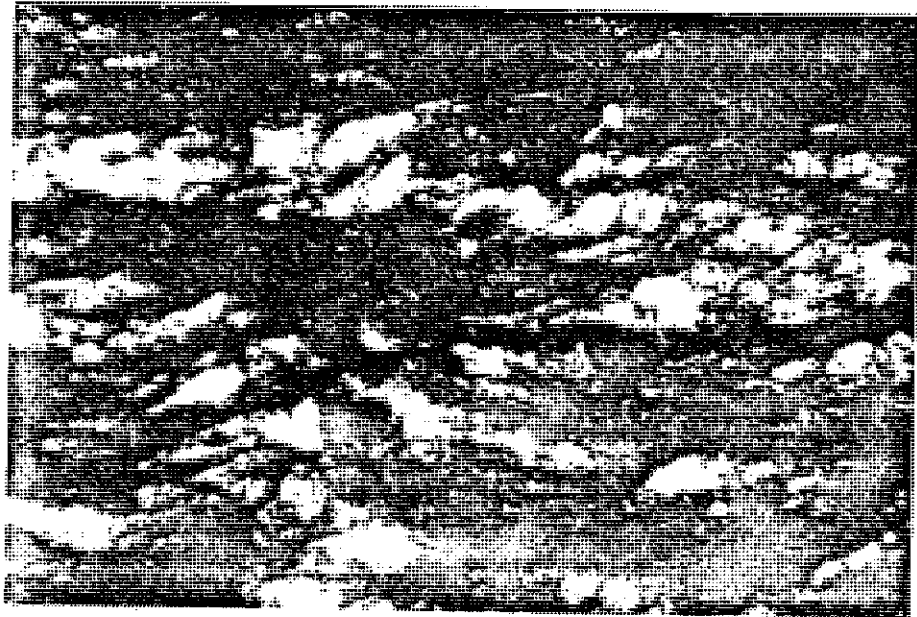
Quartz vein in soft gray "gouge". This vein is unbroken and optically continuous throughout, indicating it has not been sheared.

PHOTO A-40 - "Gouge" from Original East Wall of Trench A adjacent  
to F-1. Thin section APH-1, plane light X28.



Foliation in soft gray "gouge". Light areas are quartz and zeolite; dark areas pyrite and phyllite matrix.

PHOTO A-41 - Phyllite from Original East Wall of Trench A, 18"  
southeast of F-1. Thin section S10E, plane light, X28.



Foliation in phyllite. Light areas are quartz and feldspar;  
dark areas are phyllite matrix.

PHOTO A-42 - Phyllite from an exposure 25 feet north of F-1 in Trench A. Thin section P-3, plane light, X28.



Foliation in phyllite, very finely interbedded with metasiltstone. Dark areas are phyllite; light areas, metasiltstone.

APPENDIX B

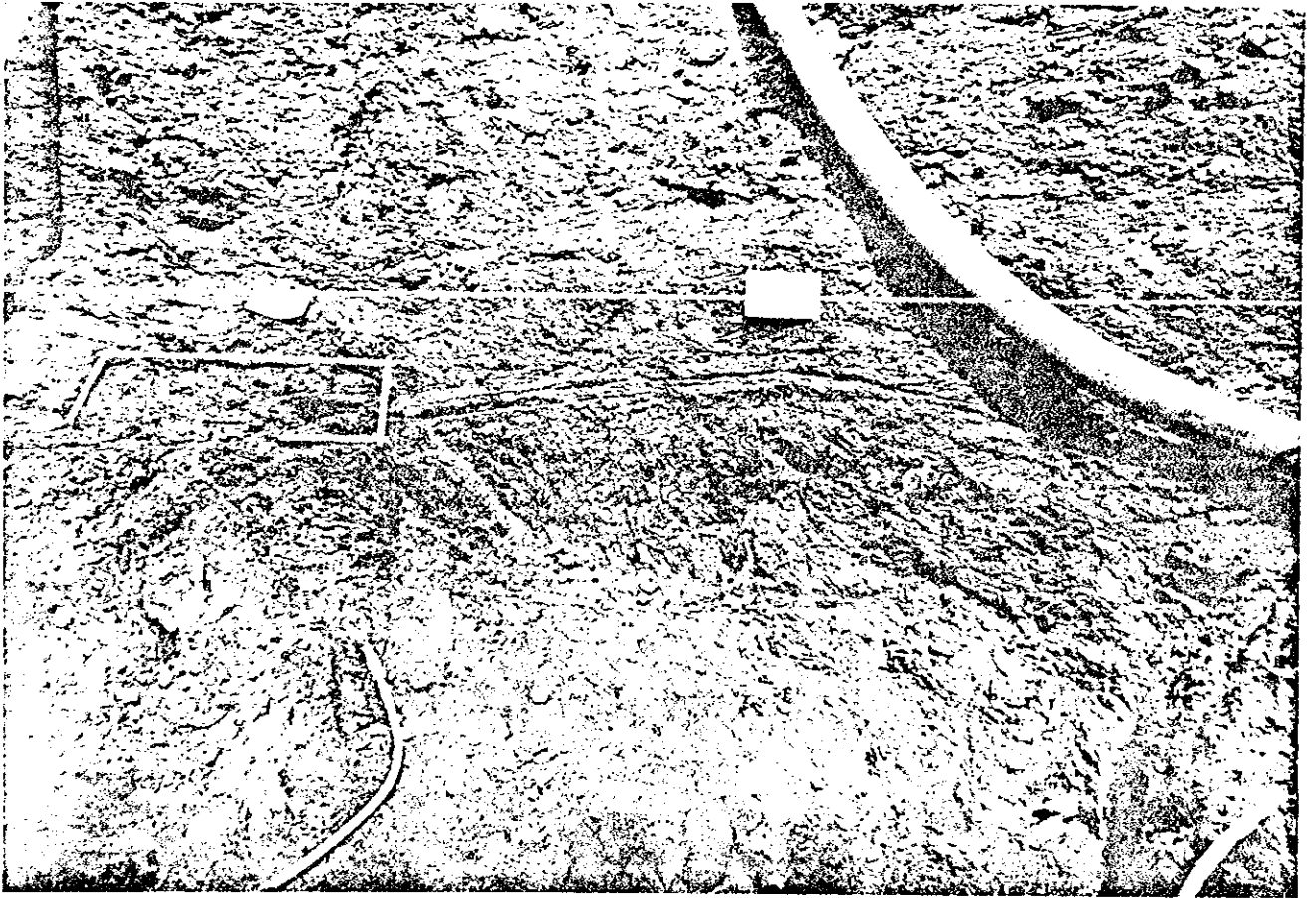
Photos of Trench B  
Contents

<u>Photo #</u>	<u>Description</u>	<u>Page</u>
B-1	East Wall, Bottom of Trench: "Bedrock Offset" and Up-Archng	B-1
B-2	East Wall, Bottom of Trench: Close-up of "Bedrock Offset"	B-2
B-3	West Wall, Bottom of Trench: Outwash/Till Contact with Bedrock	B-3a
B-4	West Wall, Bottom of Trench: Close-up of Monocline	B-4
B-5	West Wall, Bottom of Trench: Monocline	B-5
B-6	West Wall, Bottom of Trench: "Crumple" Folding in Outwash over Monocline	B-6
B-7	Rock Cut, North End of Trench: "Ferruginite" in Phyllite	B-7
B-8	West Wall, Bottom of Trench: Felsic Dike Sheared by Ice Shove	B-8
B-9	East Wall, South End: GEI Outwash/Till Sample B-F114-VII	B-9
B-10	East Wall: GEI Outwash/Till Sample B-F110-V below Ferruginite	B-10
B-11	GEI Outwash Till Sample B-F110-V	B-11
B-12	Profile of East Wall Showing Marine, Lodgment Till, Outwash, Ferruginite and Outwash/Till Units	B-12
B-13	GEI Sample B-F115-VI of Till "Mudflow" into Marine Unit	B-13
B-14	East Wall: Limonite Staining of Lodgment Till	B-14
B-15	East Wall: Edge of Marine Unit between Upper and Lower Lodgment Tills	B-15
B-16	East Wall: GEI Sample Location B-F103-II in Marine Unit	B-16
B-17	GEI Sample B-F103-II from Marine Unit	B-17
B-18	East Wall: GEI Sample Location B-F104-III in Marine Unit	B-18
B-19	GEI Sample B-F104-III from Marine Unit	B-19
B-20	East Wall, Ice Shove Deformation and Till Inclusion in Marine Unit	B-20
B-21	West Wall, South End: Ice Shove Deformation in Marine Unit	B-21

<u>Photo #</u>	<u>Description</u>	<u>Page</u>
B-22	East Wall: Location of GEI Sample B-F103-I in Upper Lodgment Till	B-22
B-23	East Wall: Fossil Ice Fissure Structures in Upper Lodgment Till	B-23
B-24	East Wall: Contact of Outwash with Ablation Till	B-24
B-25	East Wall: Close-up of Unsorted Till in Upper Outwash.	B-25
B-26	East Wall, South End: Upper Outwash Stratification, Location of GEI Samples B-F115-IX	B-26

PHOTO B-1 - Trench B, East Wall. Looking northeast.

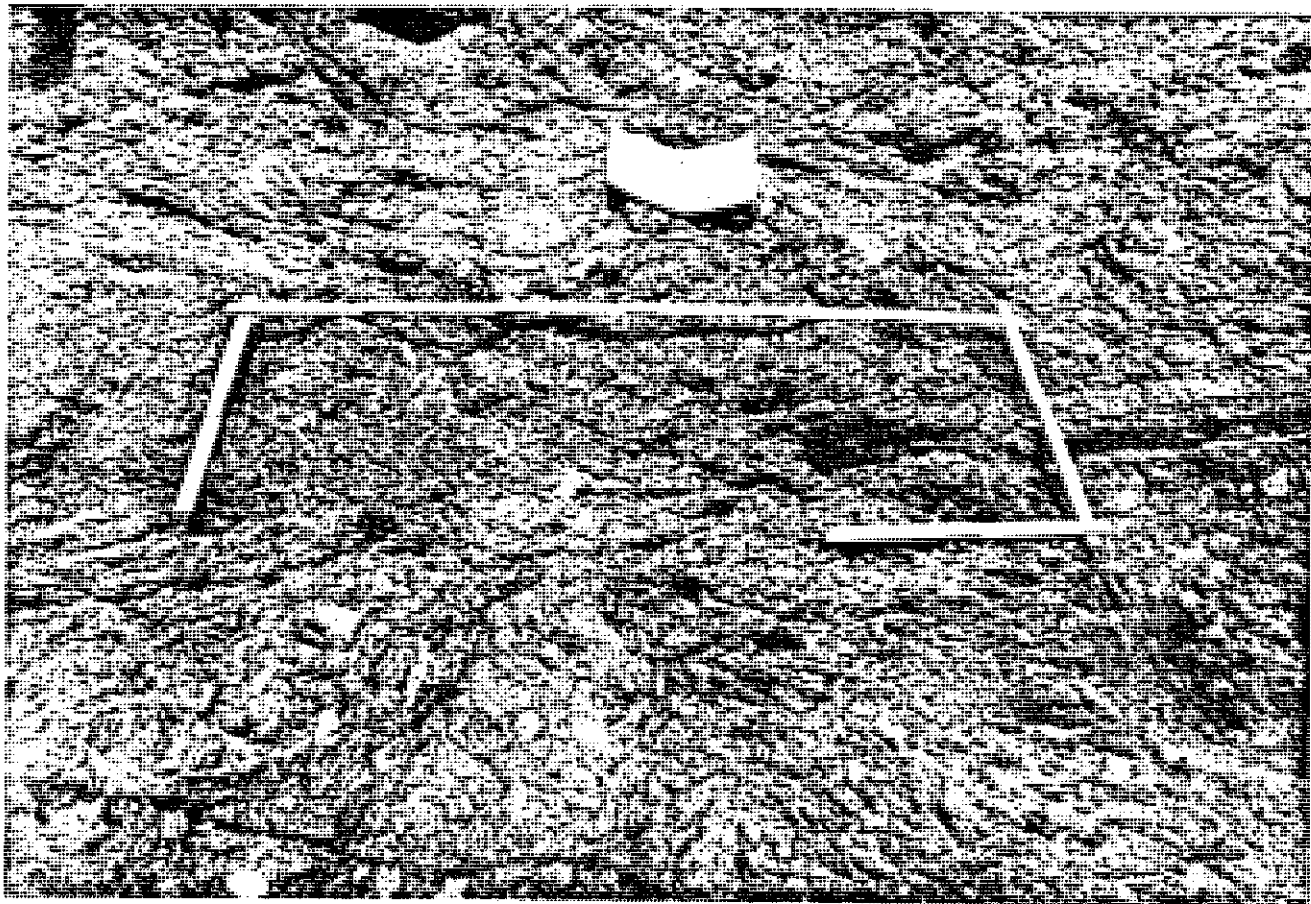
Scale 1" = Approx. 2'.



Deformed phyllite bedrock is the medium-dark blue material in the lower 60% of the photo. White streaks and masses are quartz. Pre-Laurentide rusty granular till overlies a thin laminated silt-sand layer on the bedrock surface. The bluish zones within the rusty till are isolated masses of weathered phyllite bedrock materials incorporated in the basal portion of the old till. The distinctive arching of the bedrock surface is seen in the center of the photo. The 1" rupture of the till/bedrock contact is at the dark hole within the folding rule frame. The sense of displacement on this rupture is that of a moderately low-angle overthrust on the northwestern limb of the arched bedrock.

PHOTO B-2 - Trench B, East Wall. Looking northeast.

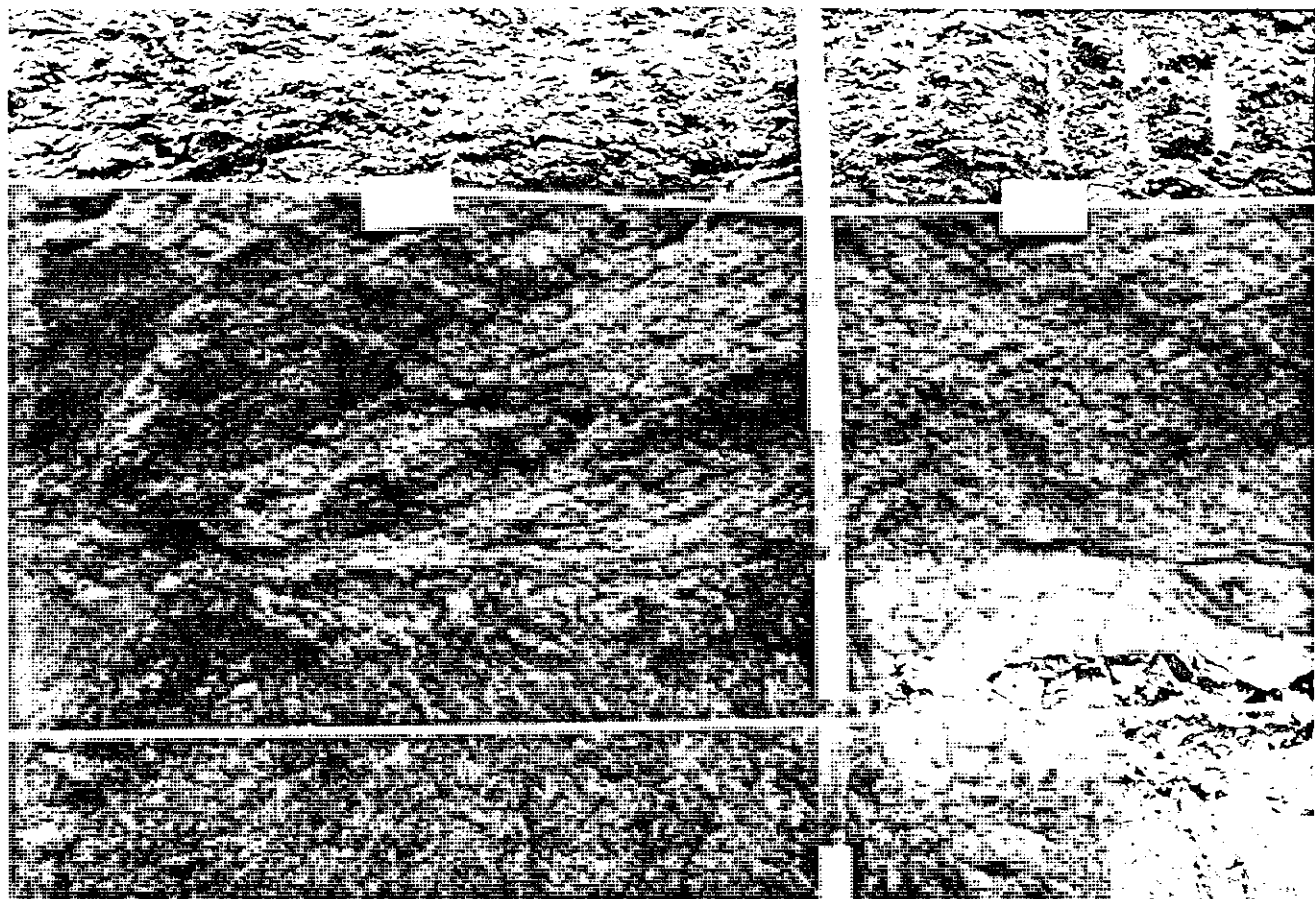
Scale 1" = Approx. 0.8'.



Detail of the 1" rupture of the till/bedrock contact. The rupture is 2.2" left (northwest) of the right border and 2.1" up from the bottom border of the photo, where dark blue weathered phyllite butts against a thin rusty laminated silt-sand unit. A vague crack rises at a moderately-low angle up to the left (northwest) through phyllite drift, to lose its identity in grayish laminated silts about 15" above the bedrock surface. Below the till/bedrock rupture the weathered phyllite is rust-stained in a localized patch (also seen just above the garden hose nozzle in Photo B-1). No "gouge" is associated with the rupture at this location.



PHOTO B-3 - Trench B, Original West Wall. Looking southwest.  
Scale 1" = Approx. 18".

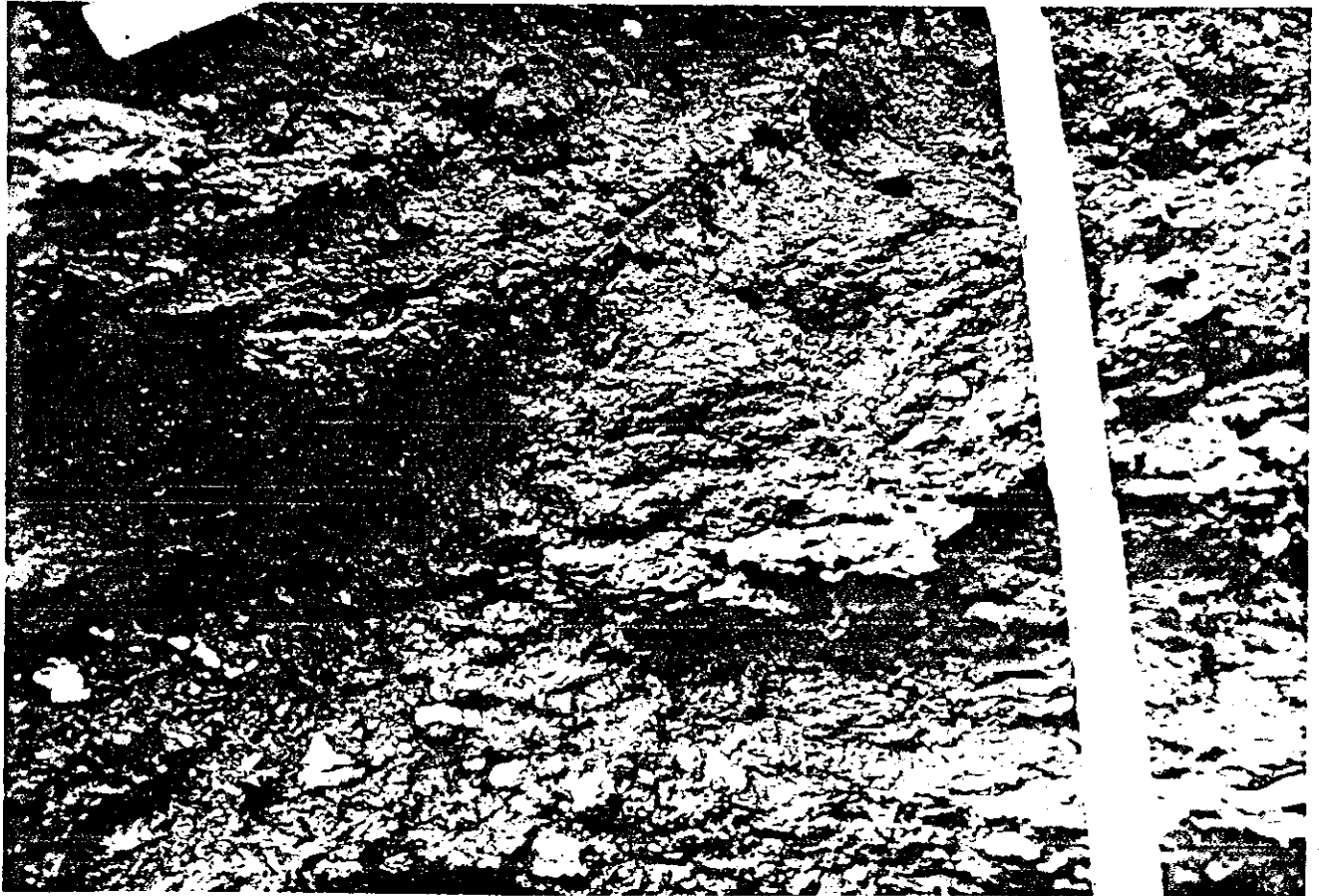


The smooth contact between weathered bedrock and rusty granular pre-Laurentide till lies about 1.7" above the bottom border of the photo. The rusty-stained whitish mass in the lower right corner is felsic dike material dated (K-Ar) at  $283 \pm 12$  million years in Sample TR-B3. The monoclinial fold of the till/bedrock surface occurs at a point 0.8" to the right (northwest) of the left border and 1.8" up from the bottom border of the photo. A moderately-dipping rusty crack rises to the northwest (right) above the monocline, to die out near the intersection of the range pole with the upper horizontal tape. The felsic dike mass in the lower right corner shows southeasterly-curving shear planes with pre-glacial normal displacements down from northwest to southeast, and also shows that the upper  $1\frac{1}{2}'$  of the mass has been displaced southeasterly

for about  $1\frac{1}{2}$ ' over phyllite bedrock. These deformations are the result of sub-glacial transport by ancient (pre-Laurentide) glacial action.

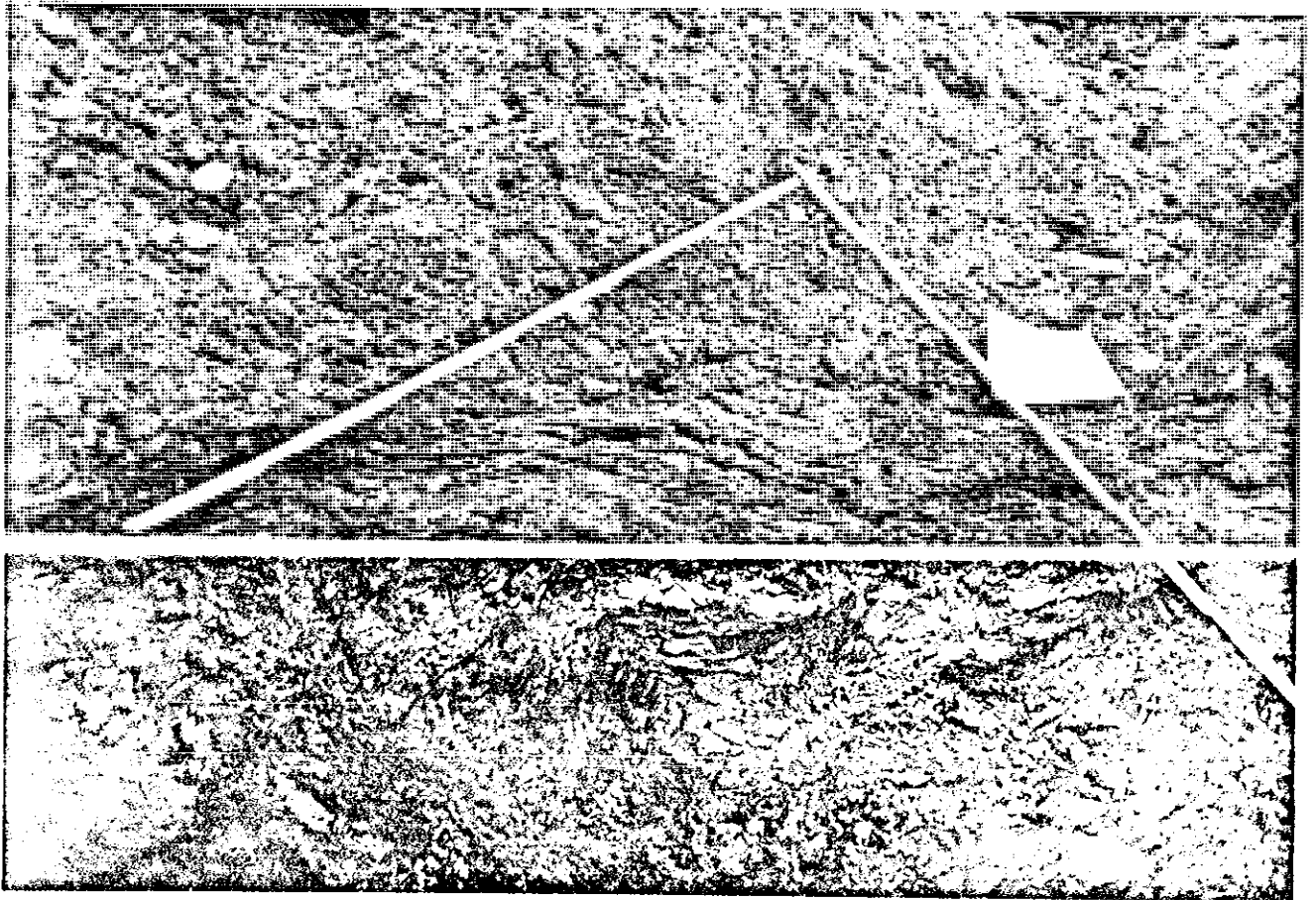
PHOTO B-4 - Trench B, Original West Wall. Looking southwest.

Scale 1" = Approx. 2".



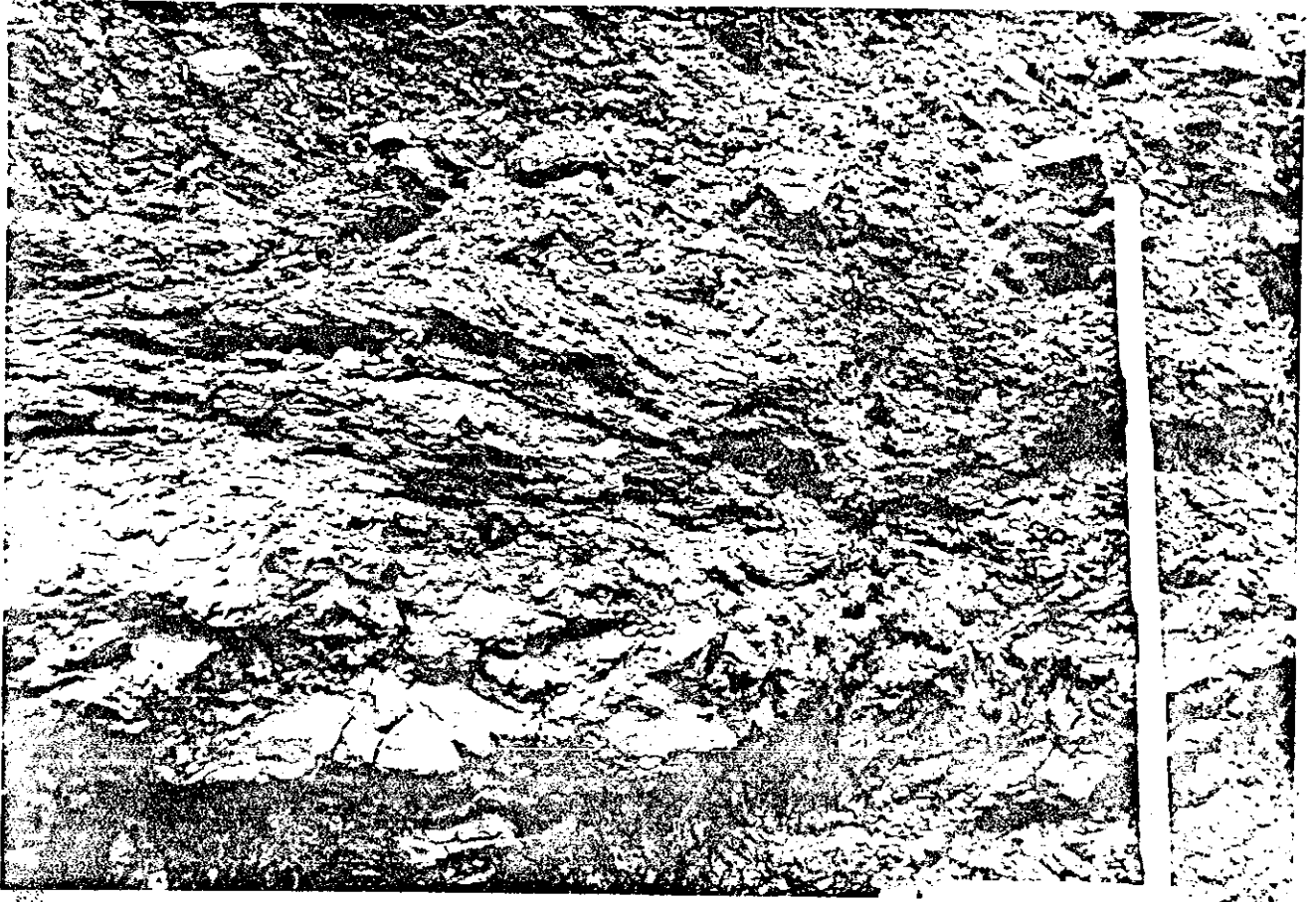
Detail of the 1" monocline on the original west wall of Trench B, at a point about 15' S34W of the 1" rupture of the till/bedrock surface on the original east wall of the trench. The monocline is 1.4" to the right (northwest) of the left border and 1.2" up from the lower border of the photo. A prominent crack dips southeasterly just to the left of the folding rule at the top border of the photo and disappears to the left of the monocline at the left border. The granular till in the footwall under this crack, above the monocline, is crumple-folded. The laminated till in the hangingwall above the crack is fairly evenly bedded. The white nodules in the (blue) weathered bedrock in the area of the monocline are a secondary mineral material which is tentatively identified as an amorphous mixture of possibly halloysite and gibbsite. The blue weathered bedrock material under the monocline has locally developed to a soft, plastic "gouge" consistency.

PHOTO B-5 - Trench B, Final West Wall. Looking southwest.  
Scale 1" = Approx. 8".



Zone of crumpled-folded granular till (pre-Laurentide) about 10' S34W of the 1" monocline seen in the original west wall of Trench B (Photos B-3 and B-4). Highly deformed phyllite bedrock lies below the smooth undulating till/bedrock surface which trends across the center of the photo just above the horizontal tape. The till/bedrock surface is slightly arched in the area framed by the folding rule and tape, and the overlying laminated till is somewhat crumpled with a vague suggestion of northwest-directed drag deformation. There is no evidence of rupture or small-scale monocline folding of the till/bedrock surface. Local zones or patches of "gouge" material occur within the deformed bedrock mass.

PHOTO B-6 - Trench B, Final West Wall. Looking southwest.  
Scale 1" = Approx. 5",



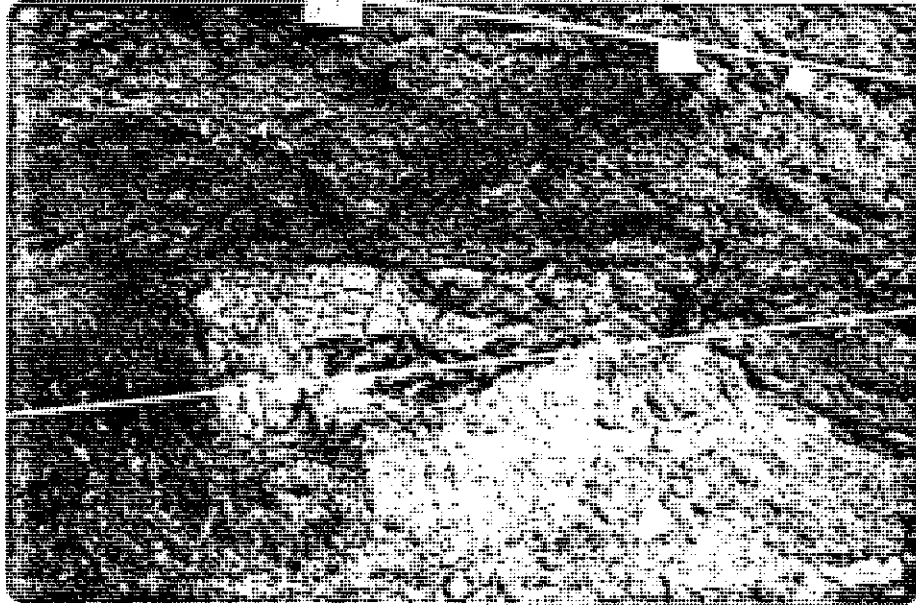
Detail of crumple-folded laminated till shown in center of Photo B-5. The bedrock surface forms a smooth undulating surface below the weakly-crumpled till, without rupture or monoclinial folding. Zones of plastic phyllite "gouge" occur in the highly deformed bedrock that lies in the shadow area along the lower one-half inch of the photo. The crumpled till shows no evidence of cracking.

Scale 1" = Approx. 1-1/3'.



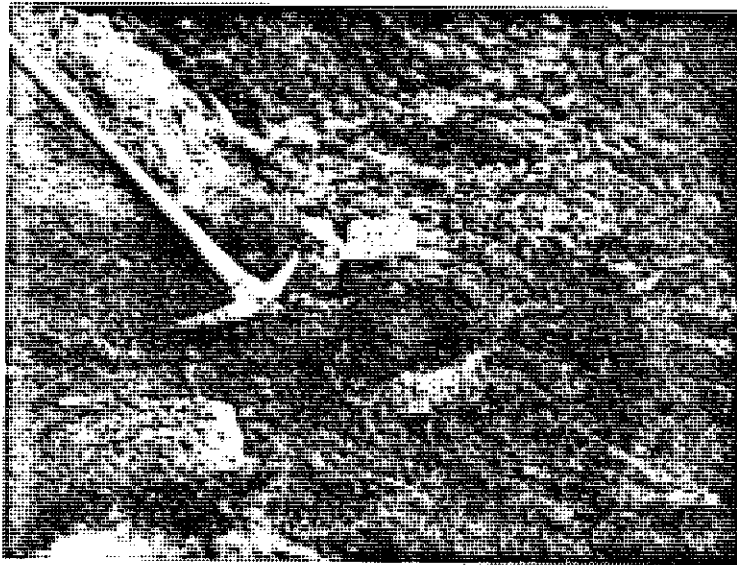
The bedding and foliation of the bedrock at the north end of Trench B strike to the northeast. The yellow rock masses running approximately parallel to bedding in the lower portion of the photo is part of a secondary deposit called a "limonitic breccia" by Professor Gene Simmons of M.I.T. A red rock mass called "ferruginite", running from the upper left corner to the lower right corner of the photo, is a portion of this secondary deposit with a probable hematitic matrix. The ferruginite fills a shear plane opening in the bedrock caused by glacial ice shove or shear. The ferruginite comes to the bedrock surface beyond the upper left corner of the photo. The ferruginite resembles a breccia--pieces of phyllite, quartz, feldspar and other lithic fragments occur in irregular laminations. Grains seldom touch; they lie in a porous matrix of iron oxides.

PHOTO B-8 - Trench B, Felsic dike on West Wall Northwest of "Monocline" View looking west. Scale 1" = Approx. 2-3/4'.



This photo illustrates bedrock displacements and disruptions that occur as a result of glacial ice shove and shear. The top of the felsic dike has been sheared and shoved southeast during glacial advance from the northwest. The shear plane is filled with granular till-like material. The top of the bedrock surface is about the middle of the photo. It is extremely difficult to estimate the depth to totally undisturbed bedrock since glacial shear planes and till seam infilling appears to penetrate quite deeply. The character of the old till/outwash of the trough of Trench B is apparent in the northern half of the photo. Note the granular texture and the SE moderately dipping "bedding" in the upper center of the photo. The material to the upper right of the photo, just above the bedrock surface, does not display any bedding.

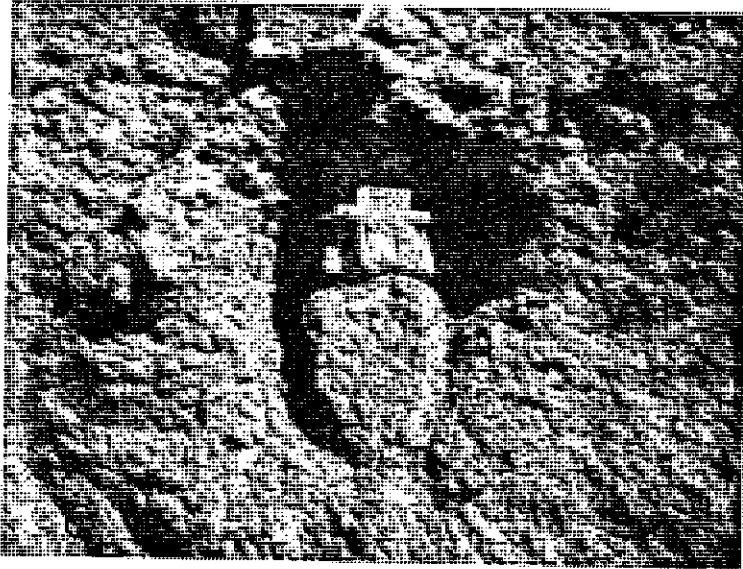
PHOTO B-9 - Trench B, GEI Sample B-F114-VIII of old outwash/till,  
east wall, south end of Trench. Scale 1"= Approx. 1'.



This dark gray gravelly silty sand has a grain size curve similar to a till. During sampling water seepage was occurring from sandy seams that appeared to be relatively horizontal.



PHOTO B-10 - Trench B, GEI Sample B-F110-V in Pre-Laurentide  
outwash/till (Unit 8), East Wall, North of Bedrock low.  
View to the northeast.      Scale 1" = Approx. 1½'.



Lightly cemented gravelly silty sand till with only a slight indication of sorting in the grain size curve. Bedding was not apparent in the sample, however. The "ferruginite" occupies the top ½" of the photo.

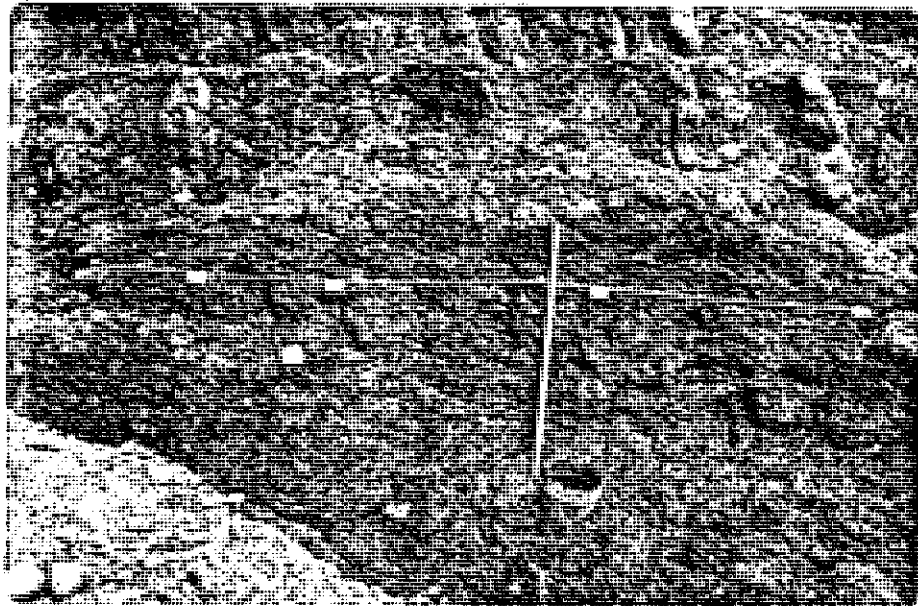
PHOTO B-11 - Trench B, GEI Sample B-F110-V of Pre-Laurentide outwash/  
till (Unit 8) from East Wall, North of Bedrock low.

Scale 1" = Approx.  $\frac{1}{4}$ '.



This sample came from the location shown in Photo B-10. Side A strikes N45°W and dips 75°SW. This particular section view does not show any evidence of bedding or sorting.

PHOTO B-12 - Trench B, East Wall, North of Bedrock Low. View to the northeast. Scale 1" = Approx. 7.5'.



This photo displays the major surficial units of Trench B. Beginning at the top of the photo: the top 1/8" of the photo shows the thinly laminated marine fine sands and silts; the next 1" of the photo shows the olive and gray main Laurentide lodgment till; the unit at the center of the photo across which the tape is stretched is an outwash; the outwash rests on the 1' thick ferruginite that runs between the 2' and 3' mark of the range pole; below the 2' mark of the range pole is the old outwash/till that in turn rests on bedrock (not seen in this picture). The gravel in the lower left corner is not native to the trench but was brought in to construct a haul road. The material in the lower right corner that does not display any particular structure is debris that has sloughed off the walls of the Trench. Note there is a general sense of "bedding" to the outwash and old outwash/till.

PHOTO B-13 - Trench B, GEI Sample B-F115-VI from the East Wall,  
South End. Scale 1" = Approx. 0.3'.



Side A is oriented N10°E and dips vertically. The peculiar entrapment of the marine unit between the two till layers was probably caused by a mudflow of Laurentide till material into the marine unit at the south end of the Trench. See Figure 9 which shows the location in the Trench Profile from which this sample was taken.

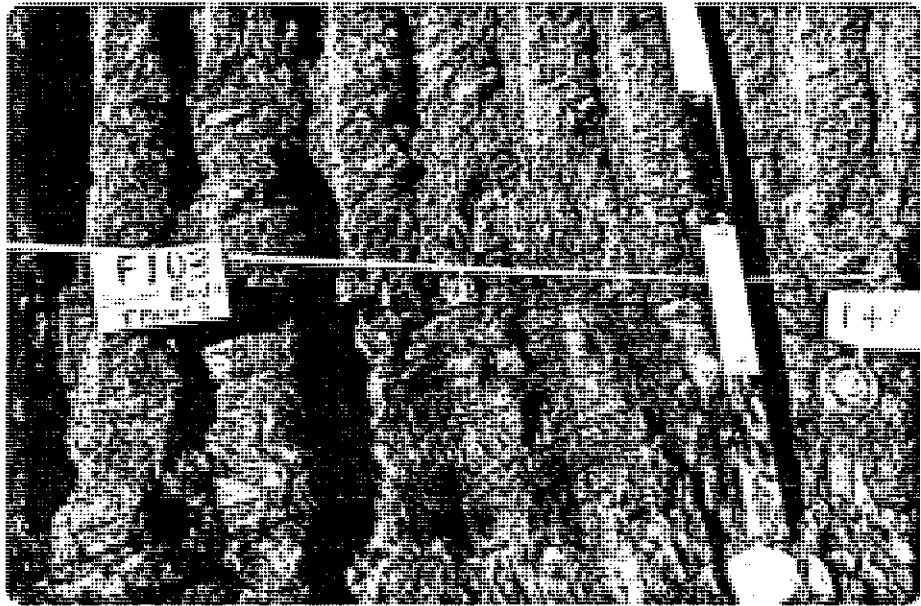
PHOTO B-14 - Trench B, East Wall, South of Bedrock Low. View to  
the east. Scale 1" = Approx. 1-1/3'.



This photo illustrates a peculiar oxidation pattern in the main gray Laurentide lodgment till. The brown till gets its color from closely spaced very thin parallel planes of limonite staining as in Photos A-22, 23 and 24. The staining pattern appears to emanate from the bedrock and terminate before reaching ground surface. Ground water rich in iron coming from the bedrock under artesian conditions below the less permeable till may have caused the staining. The fabric of the gray till here is not nearly so fissile as in the north end of the Trench. The till is not as firm here which seems to be the result of a higher silt content and a more uniform gradation in the matrix.

PHOTO B-15 - Trench B, East Wall, approximately over the bedrock low.

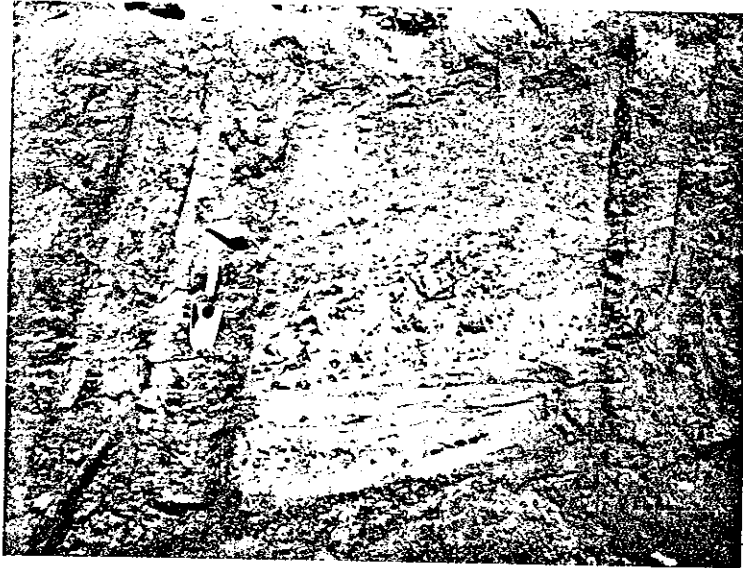
View looking to the northeast. Scale 1" = Approx. 1-1/6'.



This photo shows the marine unit of Trench B sandwiched between the main Laurentide lodgment till below, and a less dense, younger lodgment till above. The marine unit in the center of the photo is composed of an upper blocky clayey silt over thinly laminated fine sands and silts over a thin, till-like lense over more thinly laminated fine sands and silts at the bottom of the marine unit.

PHOTO B-16 - Trench B, East Wall. View looking to the northeast.

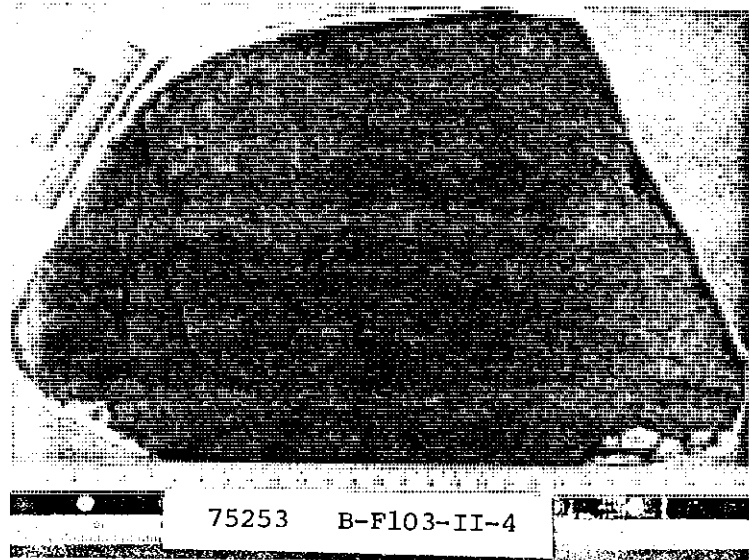
Scale 1" = Approx. 1½'.



Location of GEI Sample B-F103-II prior to removal. The top 1/3 of the cleaned portion is the upper Laurentide lodgment till, the middle 1/3 is a blocky marine silt and the lower 1/3 is a contorted, thinly laminated marine fine sand. The main Laurentide lodgment till is in the lower right hand corner of the photo.

PHOTO B-17 - Trench B of GEI Sample B-F103-II from the East Wall.

Scale 1" = Approx.  $\frac{1}{4}$ '.

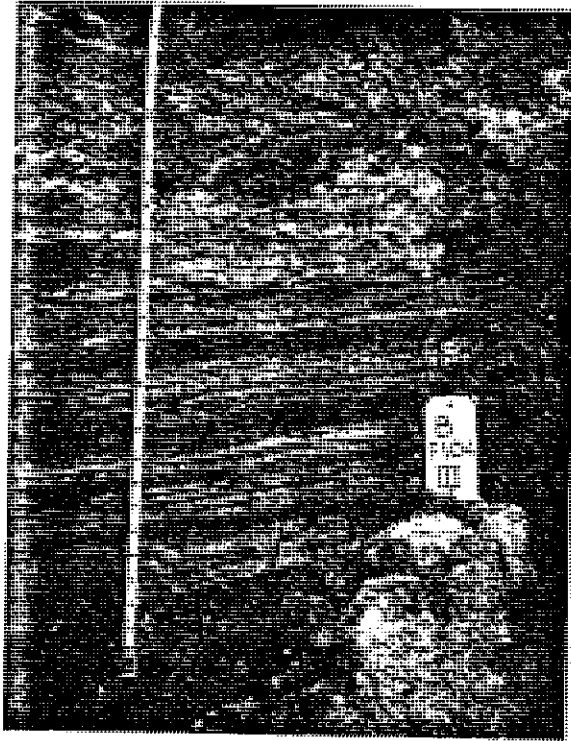


Oriented face Side A strikes  $N37^{\circ}W$  and dips  $65^{\circ}SW$ . This photo shows the bedding and structure of the marine fine sands from the location shown in Photo B-16. There is very little evidence of glacial-induced deformation in this section view.



PHOTO B-18 - Trench B, East Wall, GEI Sample Location B-F104-III.

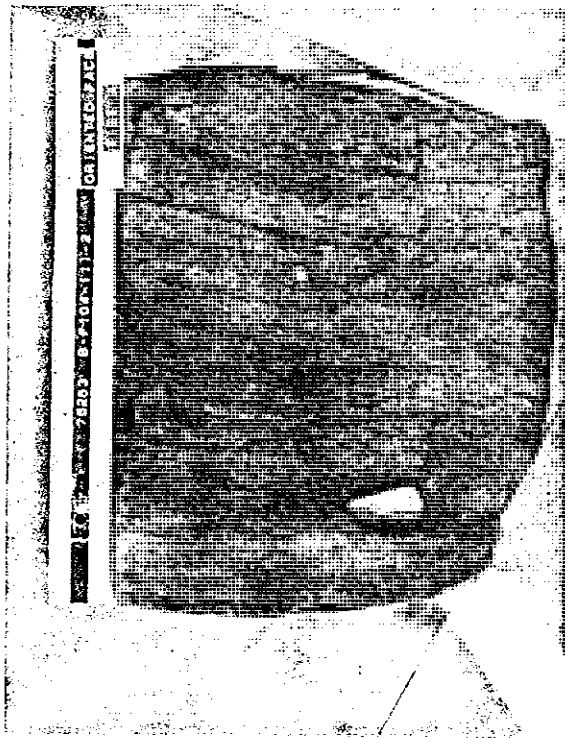
View looking to the northeast. Scale 1" = Approx. 2/3'.



This photo shows thinly-laminated marine silts and fine sands sandwiched between the lower main Laurentide lodgment till and the upper, less dense, younger Laurentide lodgment till.

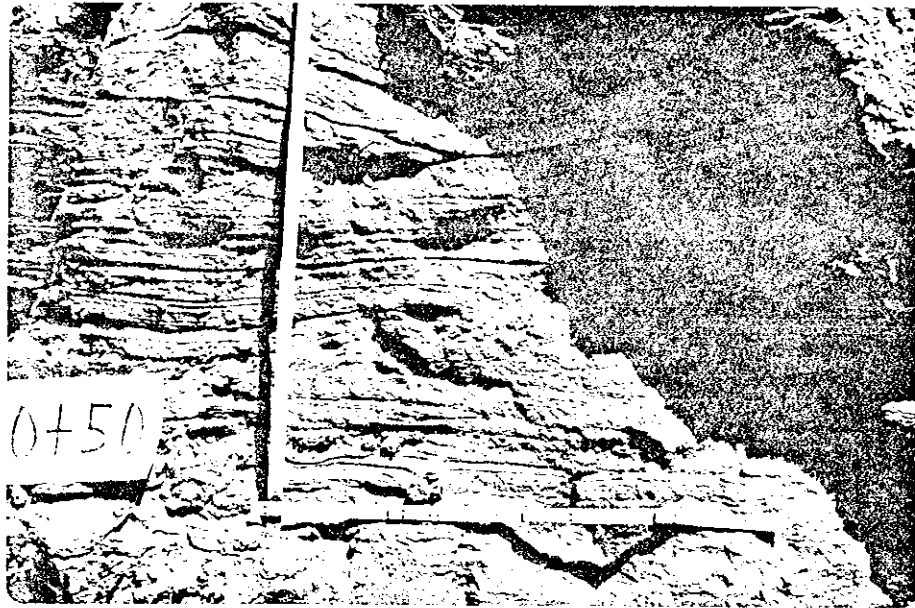
PHOTO B-19 - Trench B, East Wall, GEI Sample B-F104-III.

Scale 1" = Approx. 1/3'.



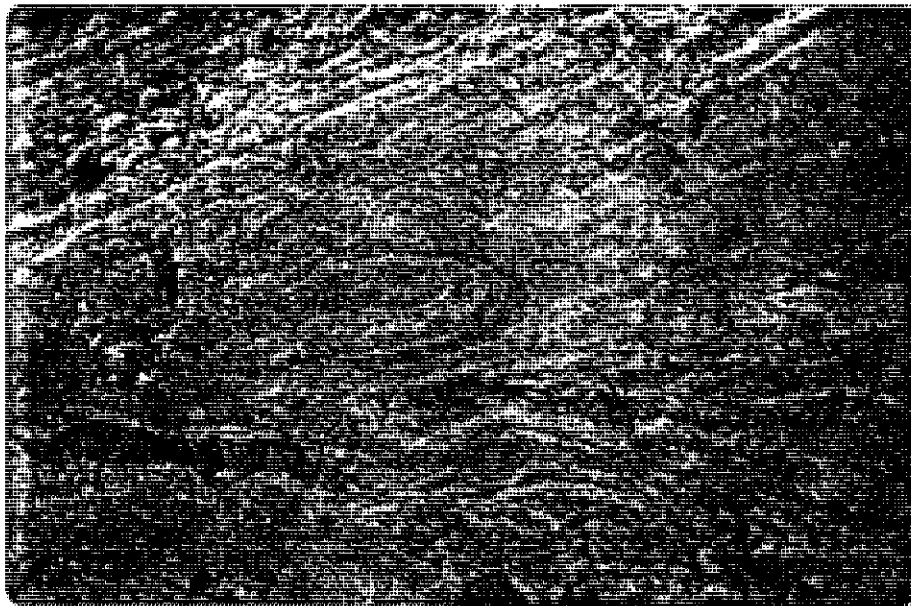
Oriented face Side A strikes north and dips  $80^{\circ}W$ . This photo is a section through the marine fine sands and silts taken from the location shown in Photo B-18. Some deformation is apparent as a result of glacial overriding from the northwest. The near vertical planar shear  $3/4$ " from the right side of the photo suggests a depression by ice loading of the west or northwest side of the marine unit relative to the east or southeast side. The gravel was apparently dropped into the unit from melting ice.

PHOTO B-20 - Trench B, East Wall. View looking to the northeast,  
at Marine Unit. Scale 1" = Approx. 3/4'.



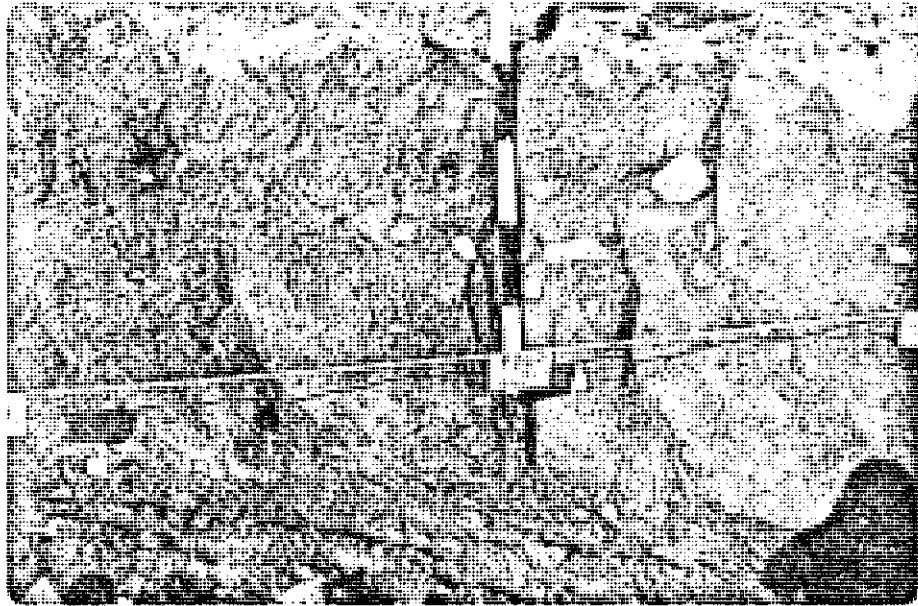
This photo shows ice-shove deformation of the marine unit in the middle of Trench B. To the right of the 30" mark on the six foot rule is a recumbent drag fold. Passing behind the 38" mark of the six foot rule is a low-angle thrust fault, also a result of ice shove from the left side of the photo. In the upper right corner of the photo are small underthrust structures resulting from simultaneous downward pressure and ice shove applied from the left side of the photo. Between the corner of the folded rule and the "0+50" card there is a clump of lodgment-like till that was apparently dropped into the marine unit during the marine deposition.

PHOTO B-21 - Trench B, South end of West Wall. View toward the southwest. Scale 1" = Approx.  $\frac{1}{4}$ '.



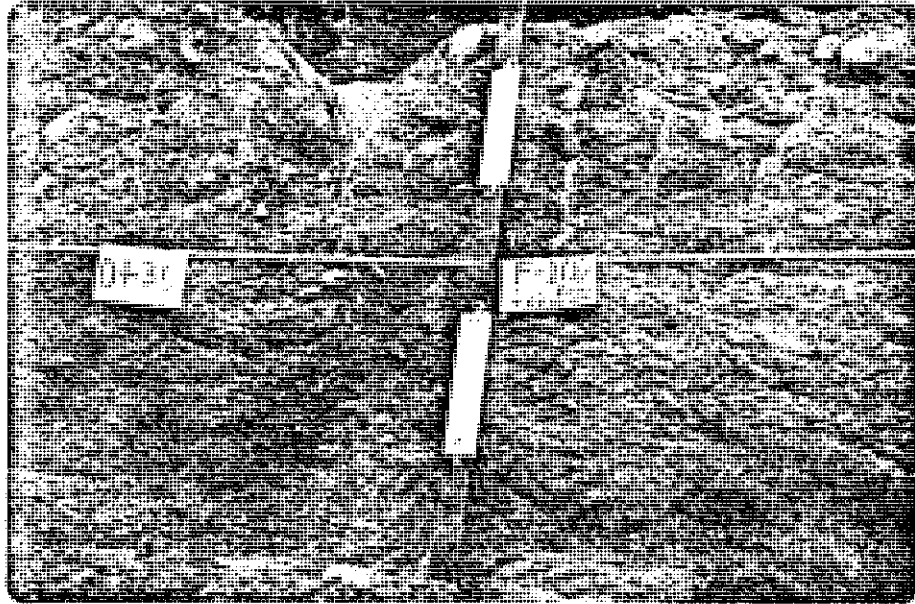
This photo illustrates drag folding deformation in marine fine sands and silts as a result of glacial overriding from the right side of the photo.

PHOTO B-22 - Trench B, East Wall, North end of Trench. View  
toward the east. Scale 1" = Approx. 2½'.



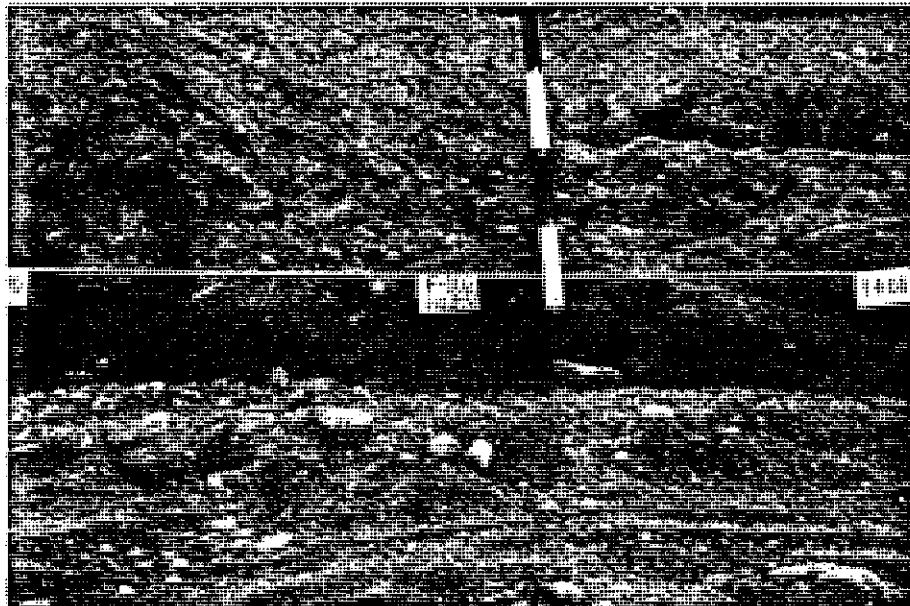
This is upper Laurentide lodgment till situated above the marine unit in Trench B. This till is very similar to the main Laurentide lodgment till except that the density of this upper till is lower. Since this upper till was deposited during a minor readvance near the end of the glaciation, 13,000 B.P., the consolidation stress (somewhat proportional to ice thickness) was not nearly as high as during the peak of the glaciation 17,000 to 19,000 B.P. GEI Sample B-F103-I was taken just to the left of the 2' mark on the range pole.

PHOTO B-23 - Trench B, North end of East Wall. View looking  
northeast. Scale 1" = Approx. 1-1/3'.



This is upper Laurentide lodgment till deposited during a late minor readvance. This particular exposure is near original ground level and mottling is prominent. Notice the fissile fabric and pebble imbrication. The more or less vertical thin gray structures may be fossil ice fissures.

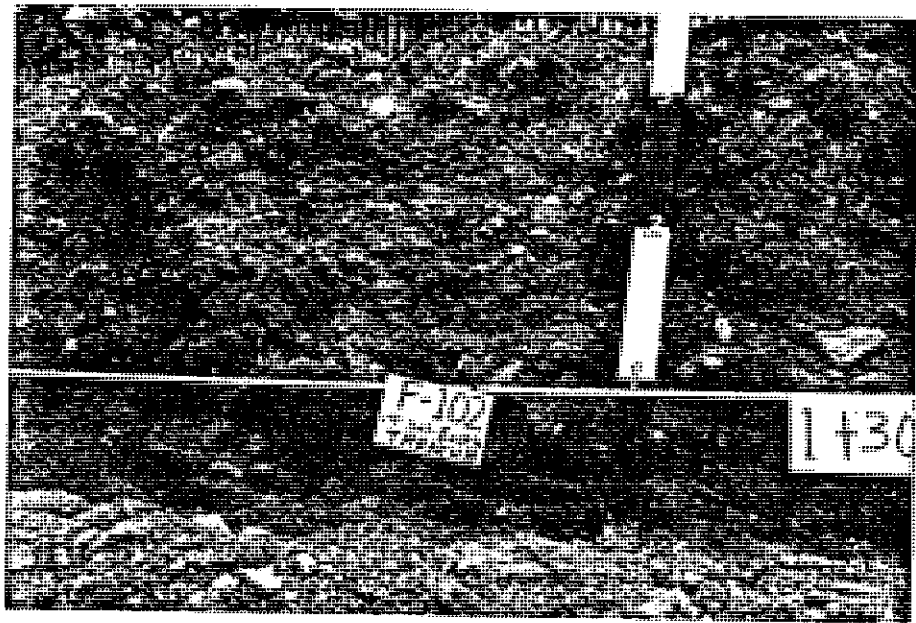
PHOTO B-24 - Trench B, middle top of East Wall. View to the East. Scale 1" = Approx. 2½'.



This is the top bench of Trench B. The loose material seen in the top ½" of the photo is material dumped on top of the original ground surface. The material between the 1' and 3½' mark on the range pole is ablation till on the left half of the photo which changes into sorted, bedded outwash on the right half of the photo. The upper Laurentide lodgment till is below the 1' mark on the range pole. Notice that the transition from ablation till to outwash begins near the bottom of the ablation till and initially dips toward the northwest. This suggests that meltwater was flowing southeasterly out through the bottom of a glacier which lay to the northwest, the edge of which must have been close to this transition point.

PHOTO B-25 - Trench B, Top of East Wall. View to the northeast.

Scale 1" = Approx. 1-1/3'.



This photo is taken 35' southeast of Photo B-24. The top of the surficial profile (above 1' on the range pole) is outwash. The upper Laurentide lodgment till is below 1' on the range pole. Note the crude stratification and granular nature to the left of the range pole. A clump of unsorted lodgment-type till lies just to the right of the range pole between 1½' and 3' on the range pole. The inclusion of this unsorted till in the middle of stratified outwash suggests it was dropped here during deposition of the outwash below sea level.

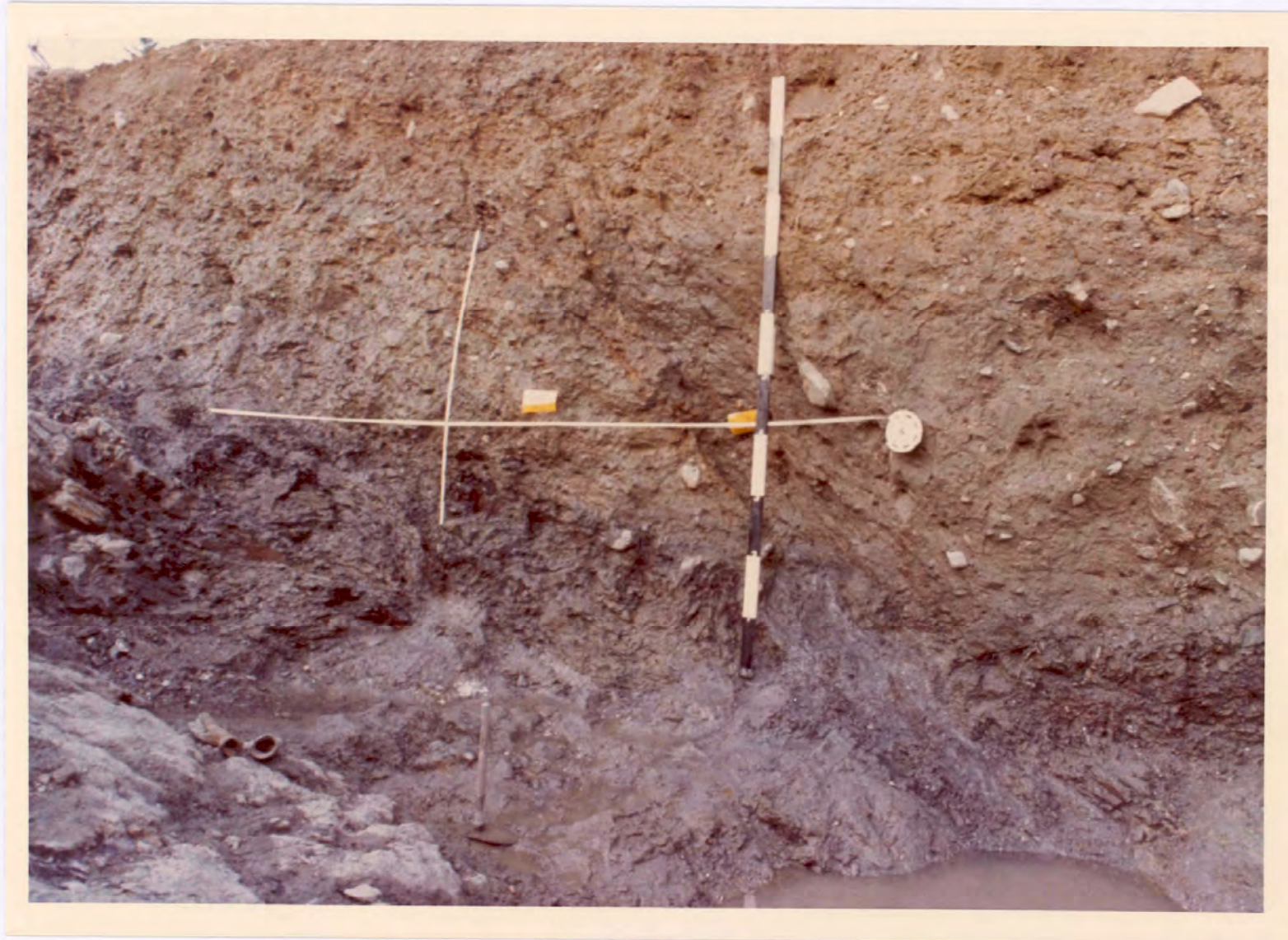


PHOTO B-26 - Trench B, Outwash near top of South End. View to the East. Scale 1" = Approx.  $\frac{1}{2}$ '.



The outwash at the south end of Trench B is approximately 3' thick here. Note the variation in grain size, degree of sorting and bed thickness. The units between 19" and 21" and 9" and 13" on the six foot rule are fairly widely graded although lacking in fines. The grain size curves for individual strata of this outwash are compared with grain size curves for sands and gravels from actual active beaches at the north end of Sears Island on Graphs C-14, 15, 16 and 17. Other comparisons are made in Table C-10. (GEI Sample location B-F115-IX)

A-1





A-2





A-3





A-4





A-5





A-6



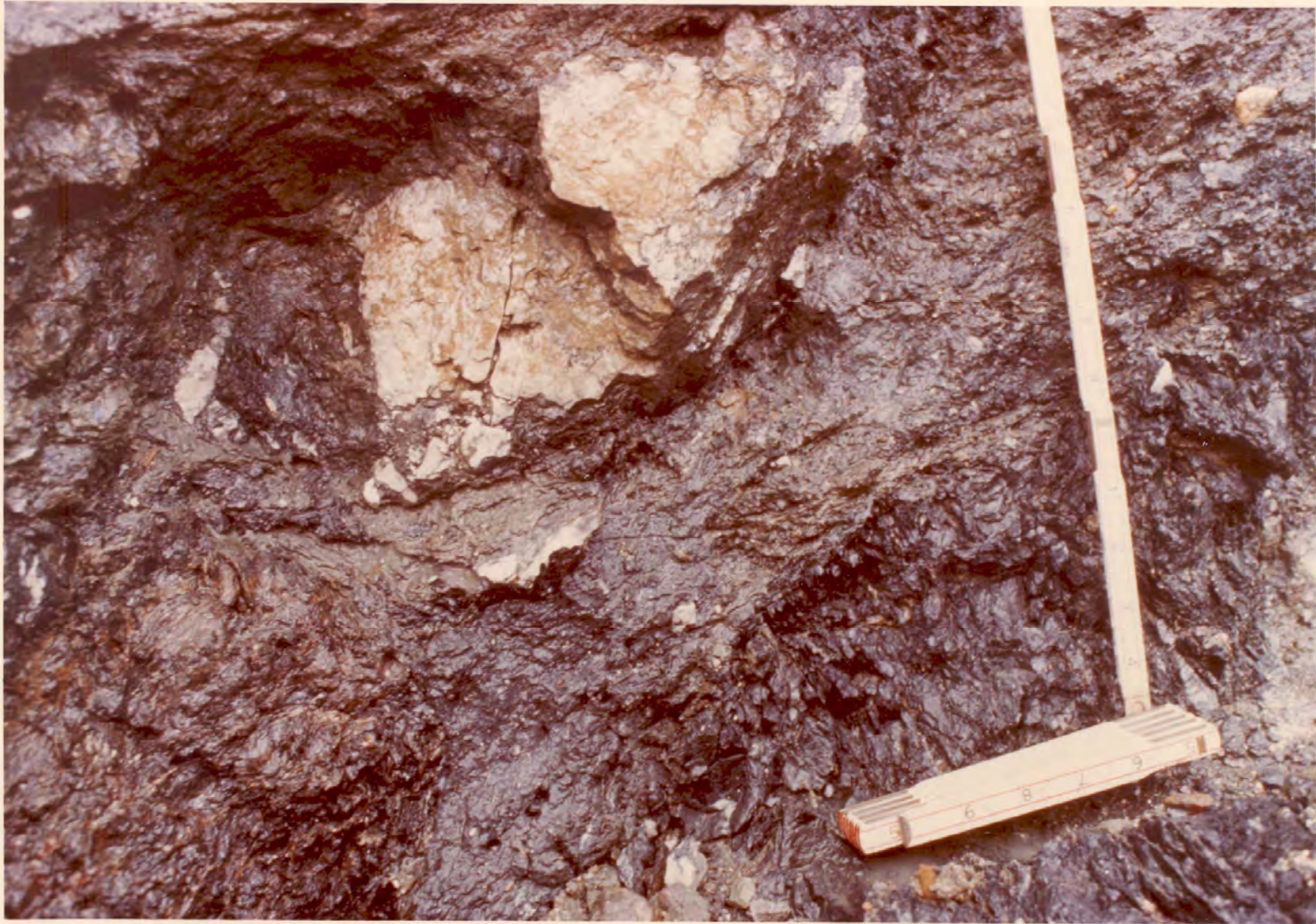


A-7



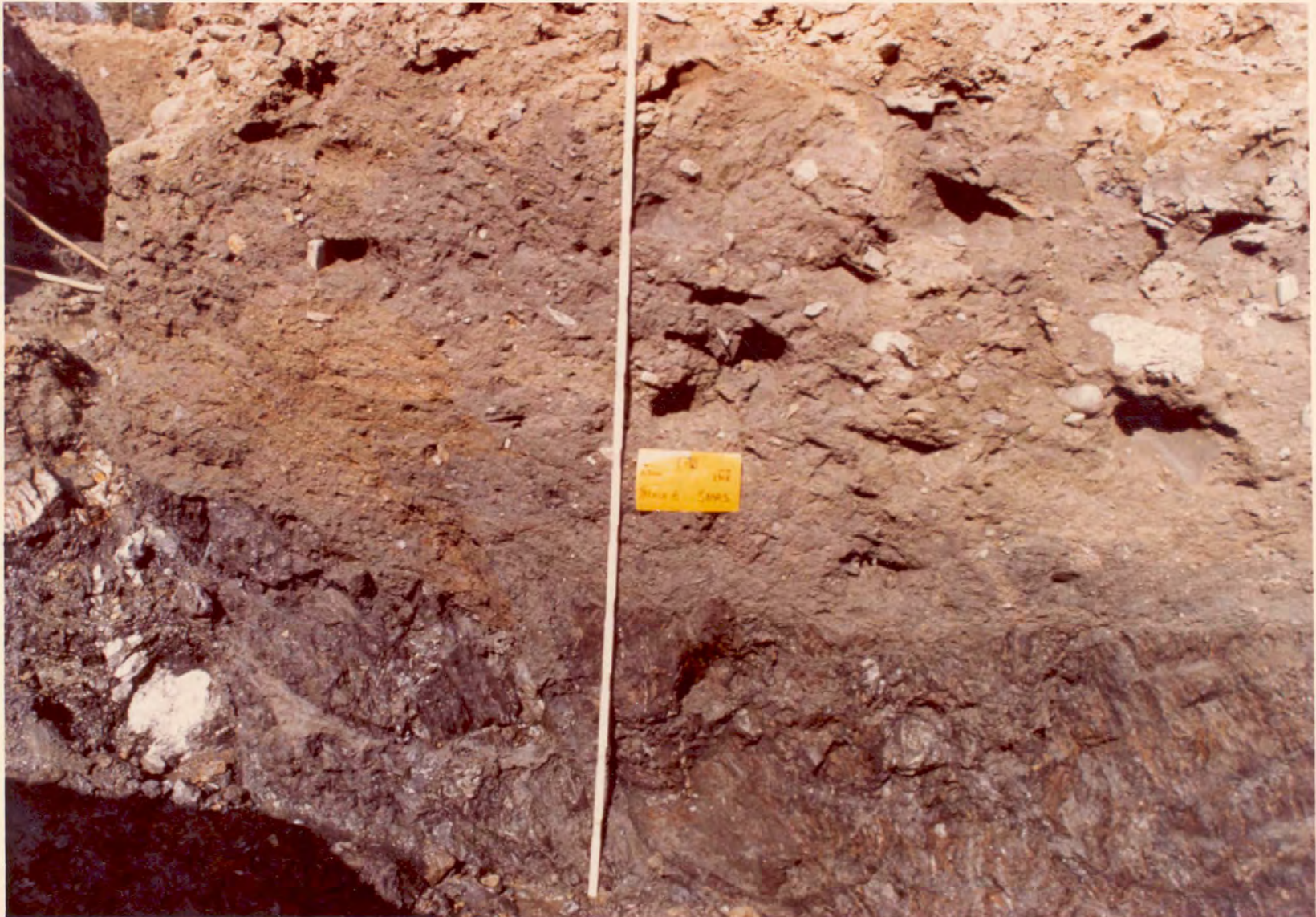


A-8



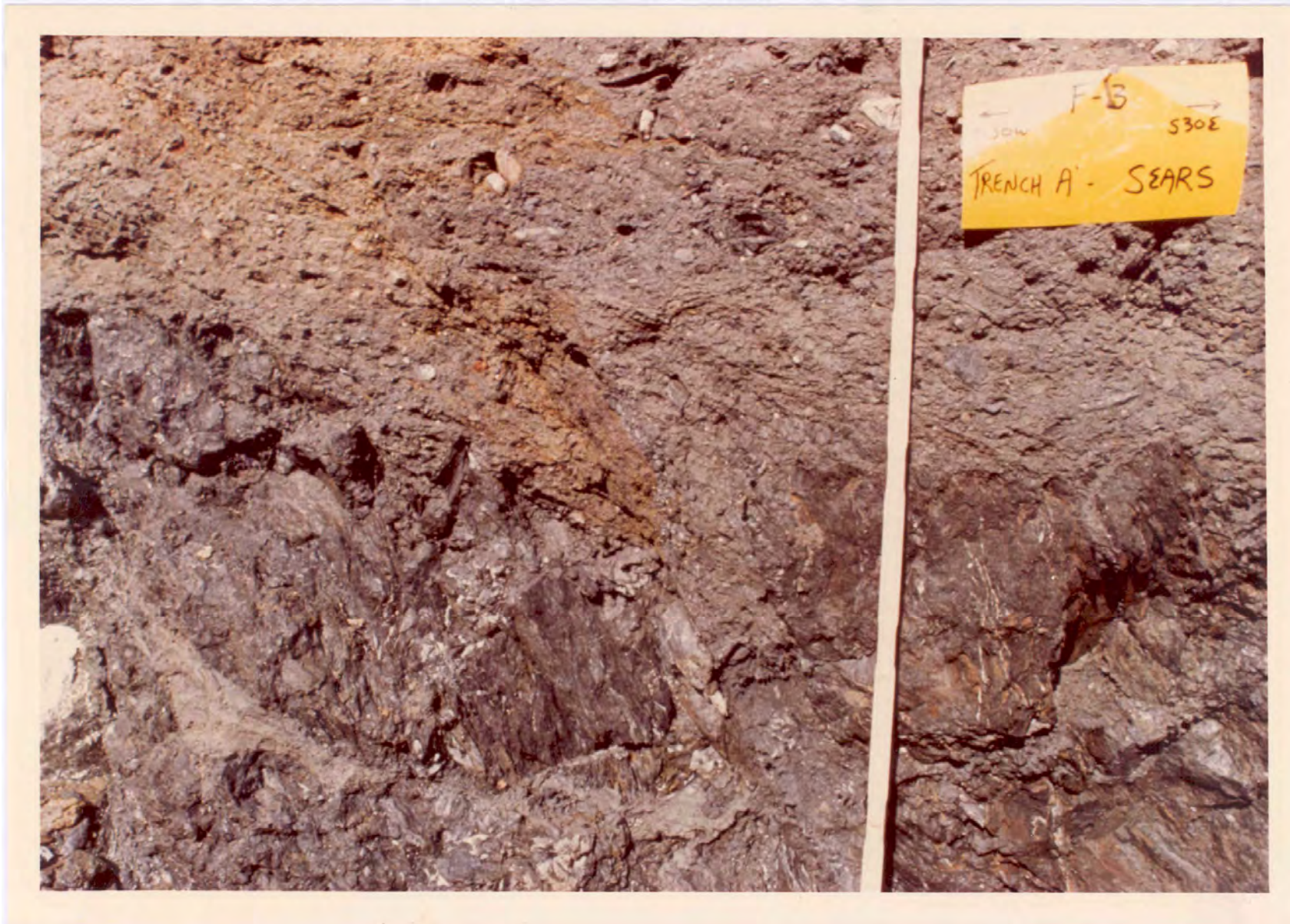


A-9





A-10





A-11





A-12





A-13





A-14

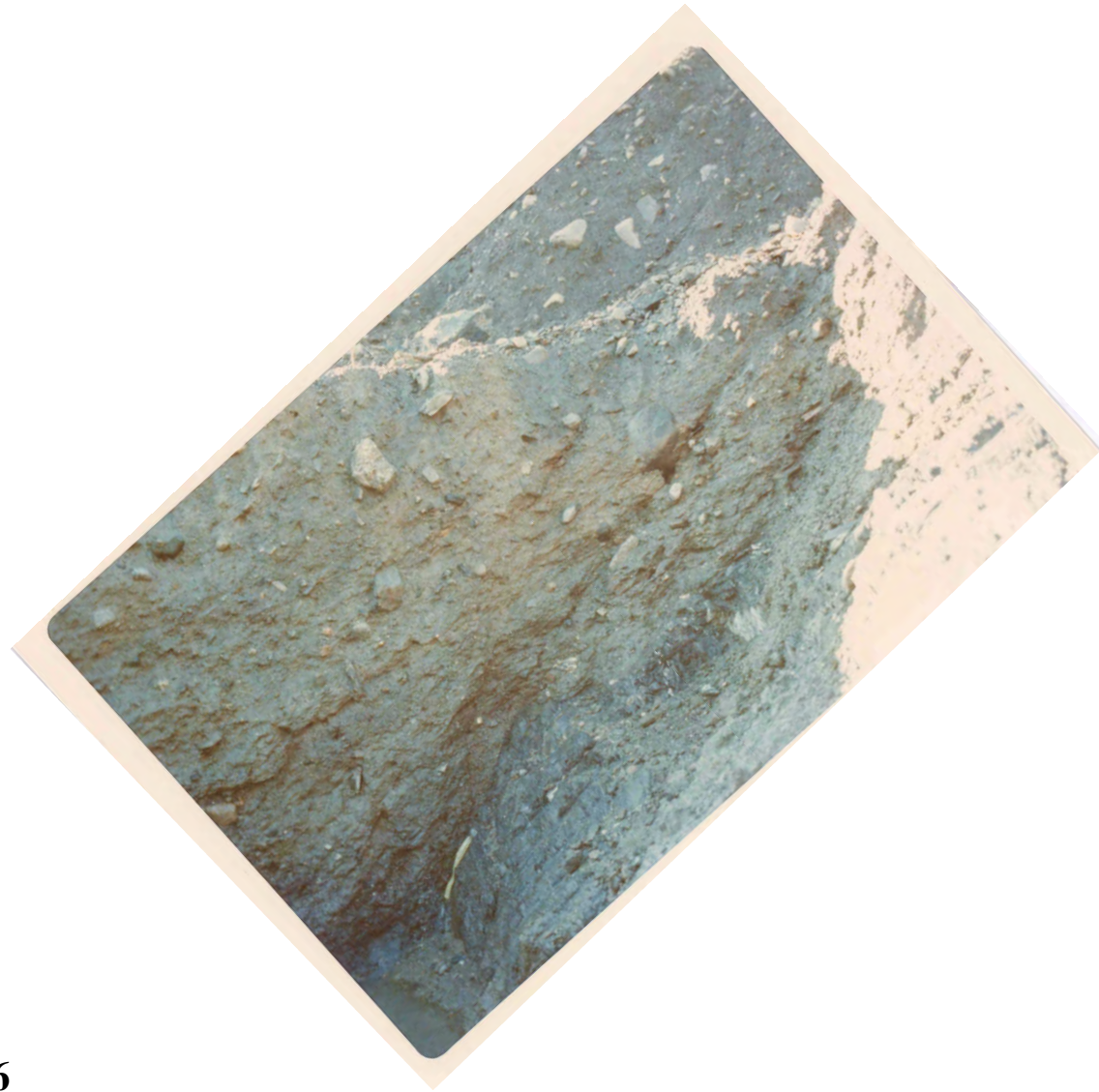




A-15







**A-16**

A-17





A-18





A-19

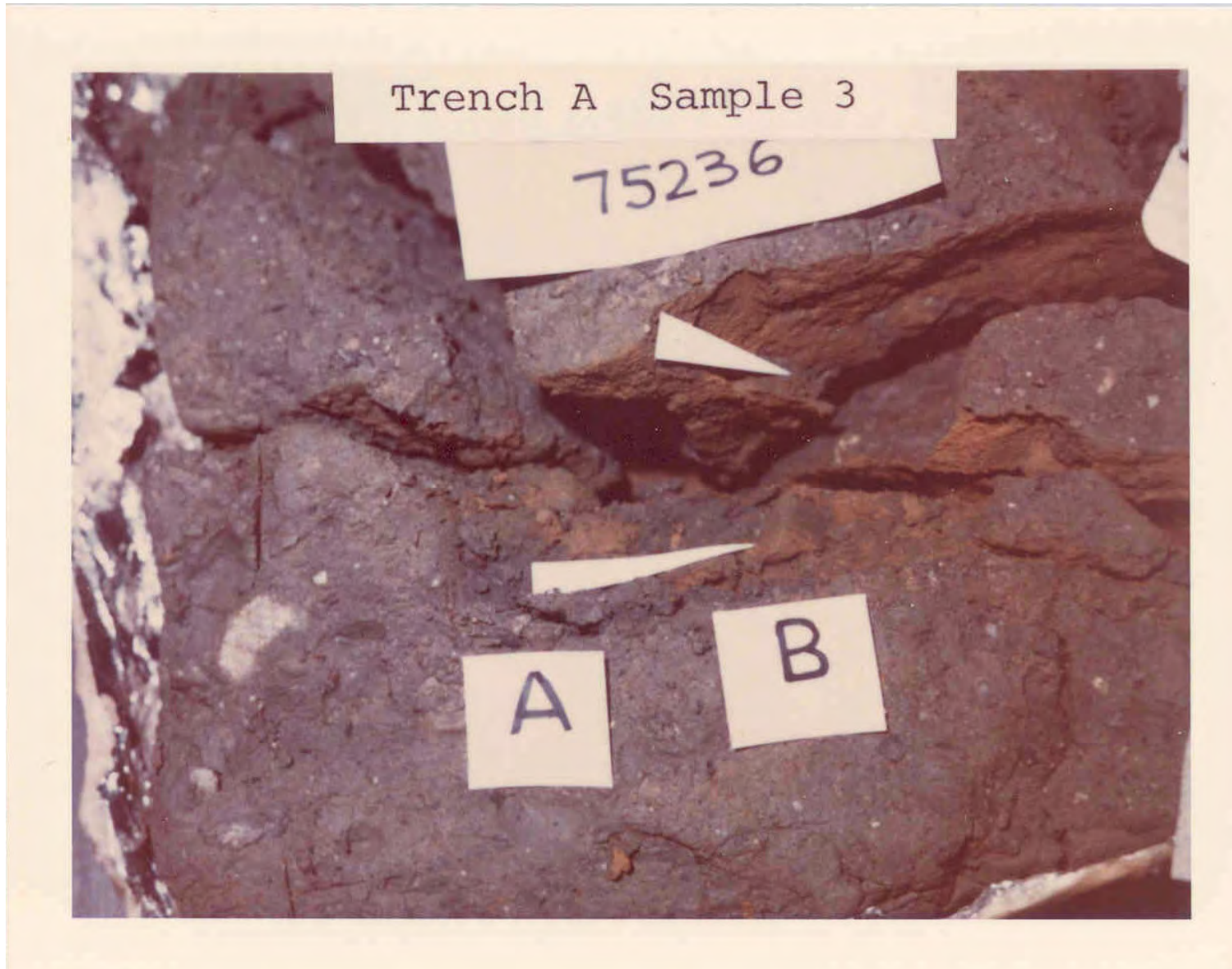




A-20



A-21





A-22



A-23





A-24





A-25





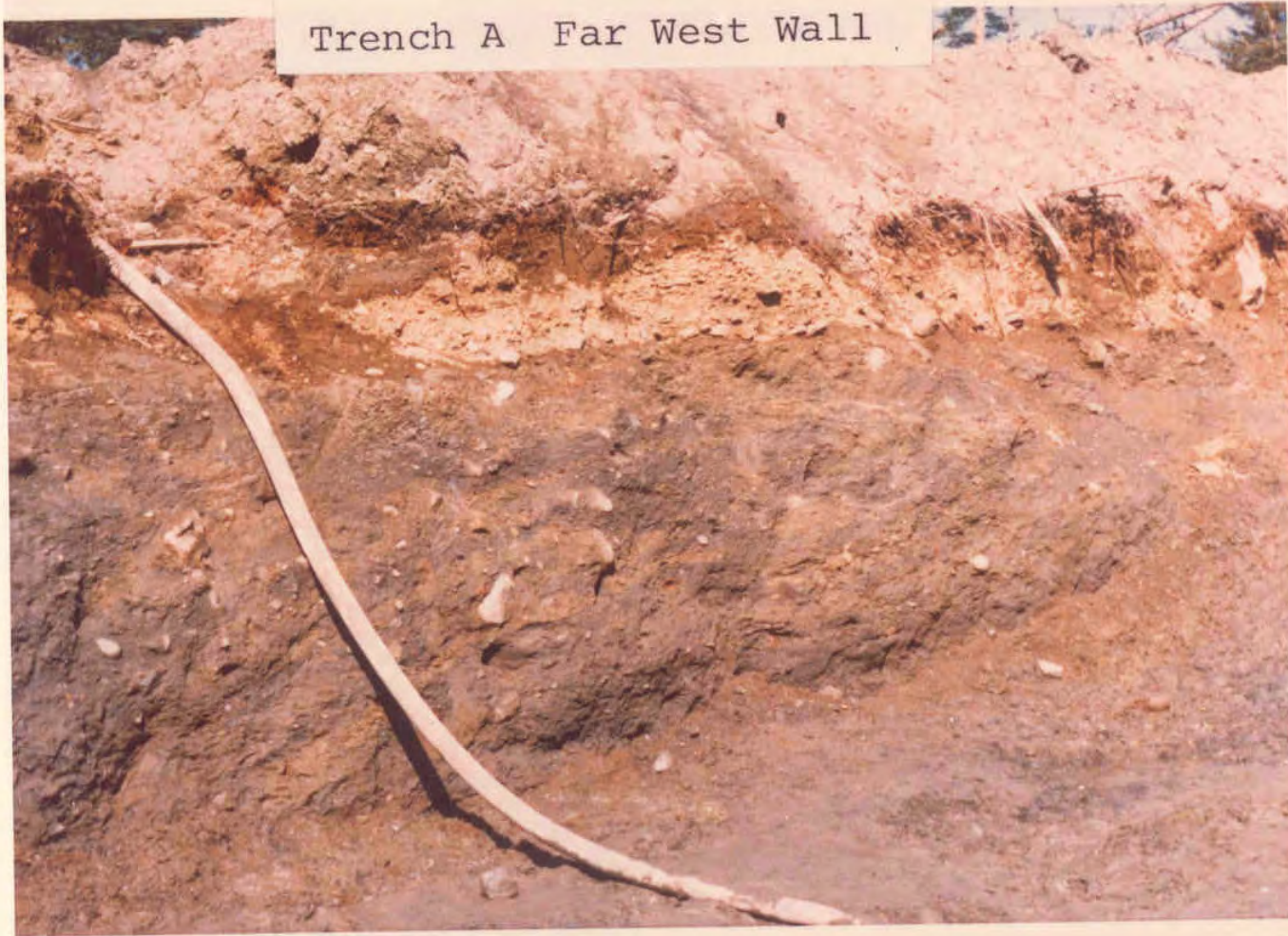
A-26





A-27

Trench A Far West Wall





A-28





A-29

PROJECT 75236

SAMPLE 26

Rotational Shear

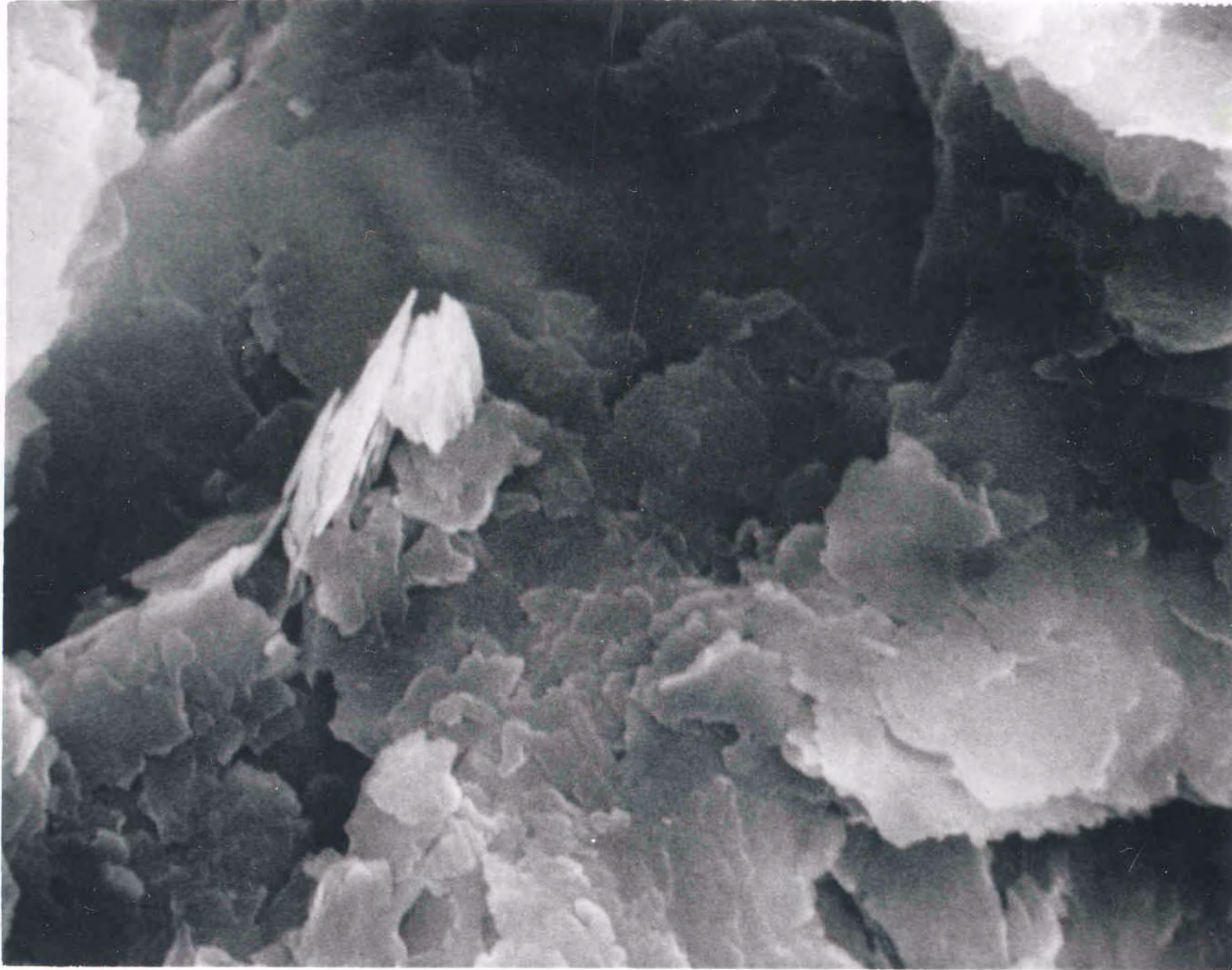
One Revolution

$\sigma_v = 19.9 \text{ kg/cm}^2$

June 26, 1975

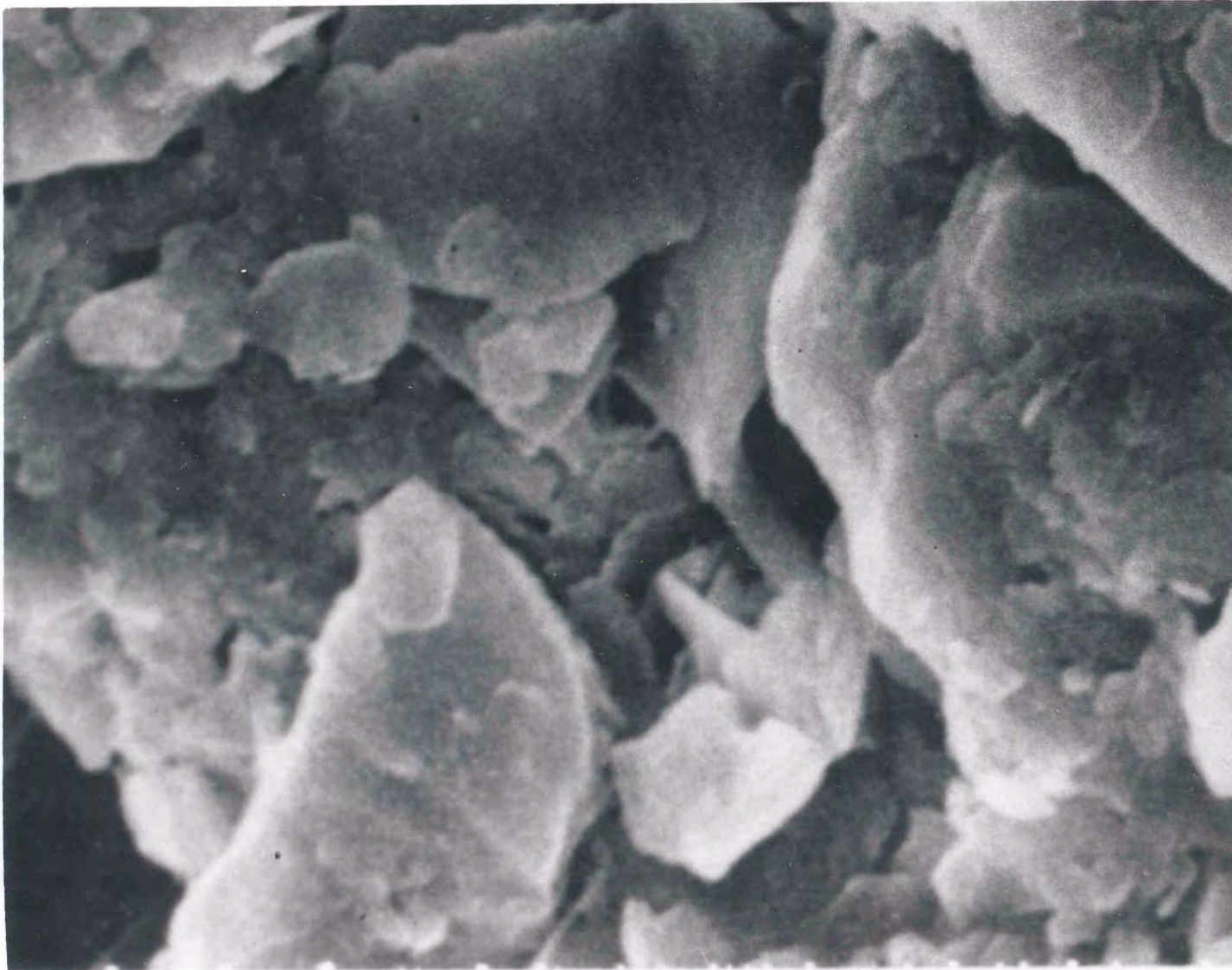


A-30



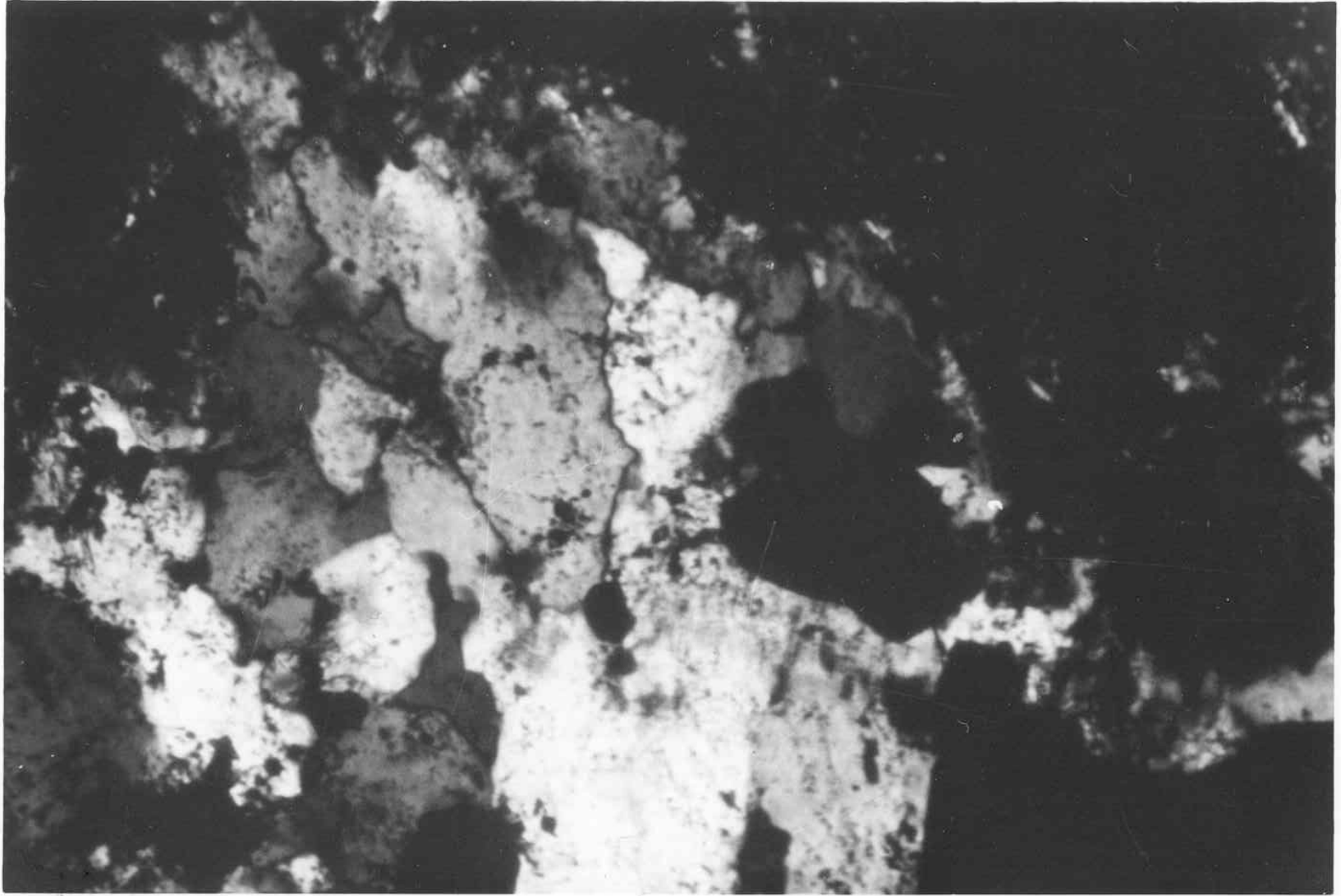


A-31



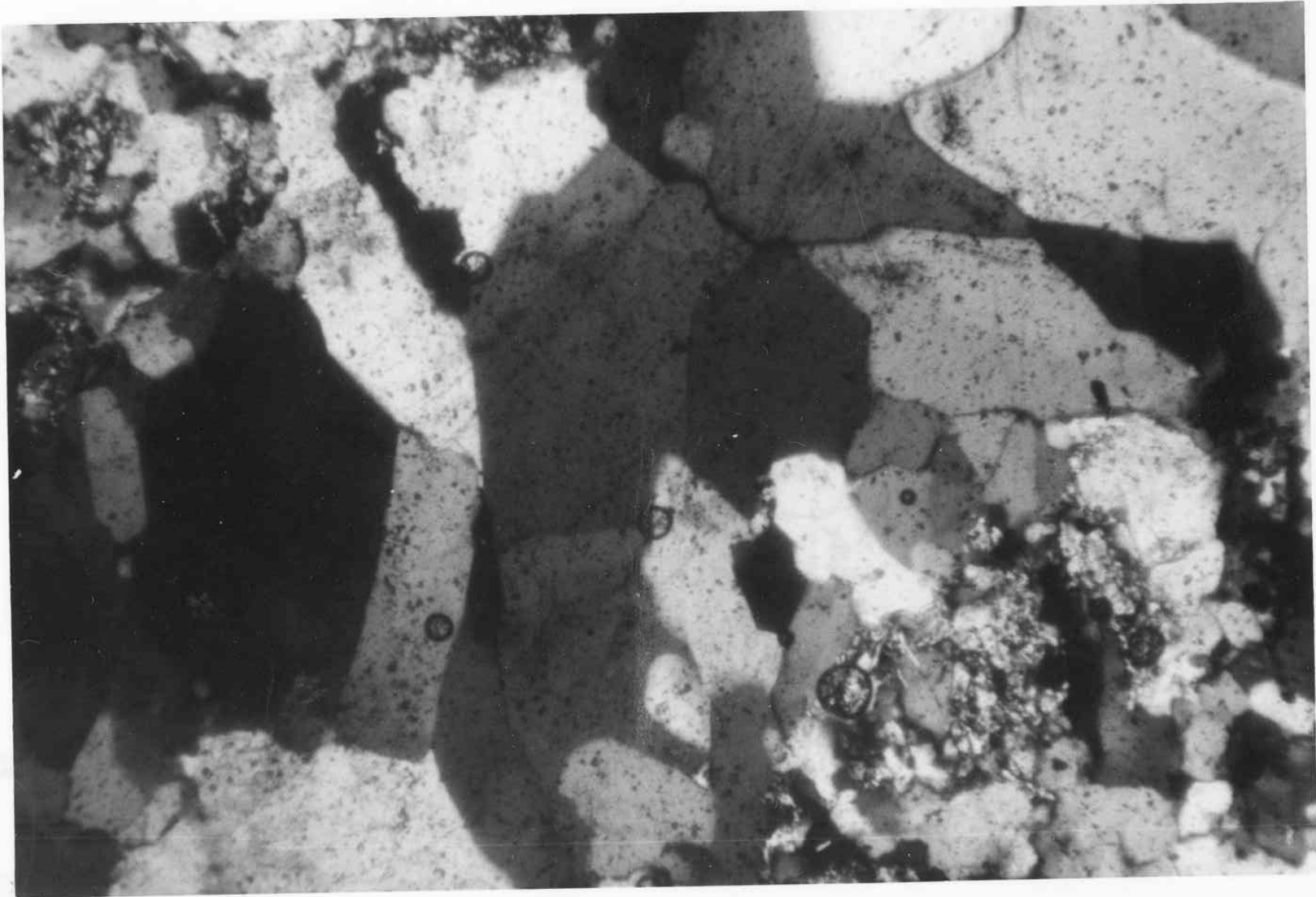


A-32



07 071

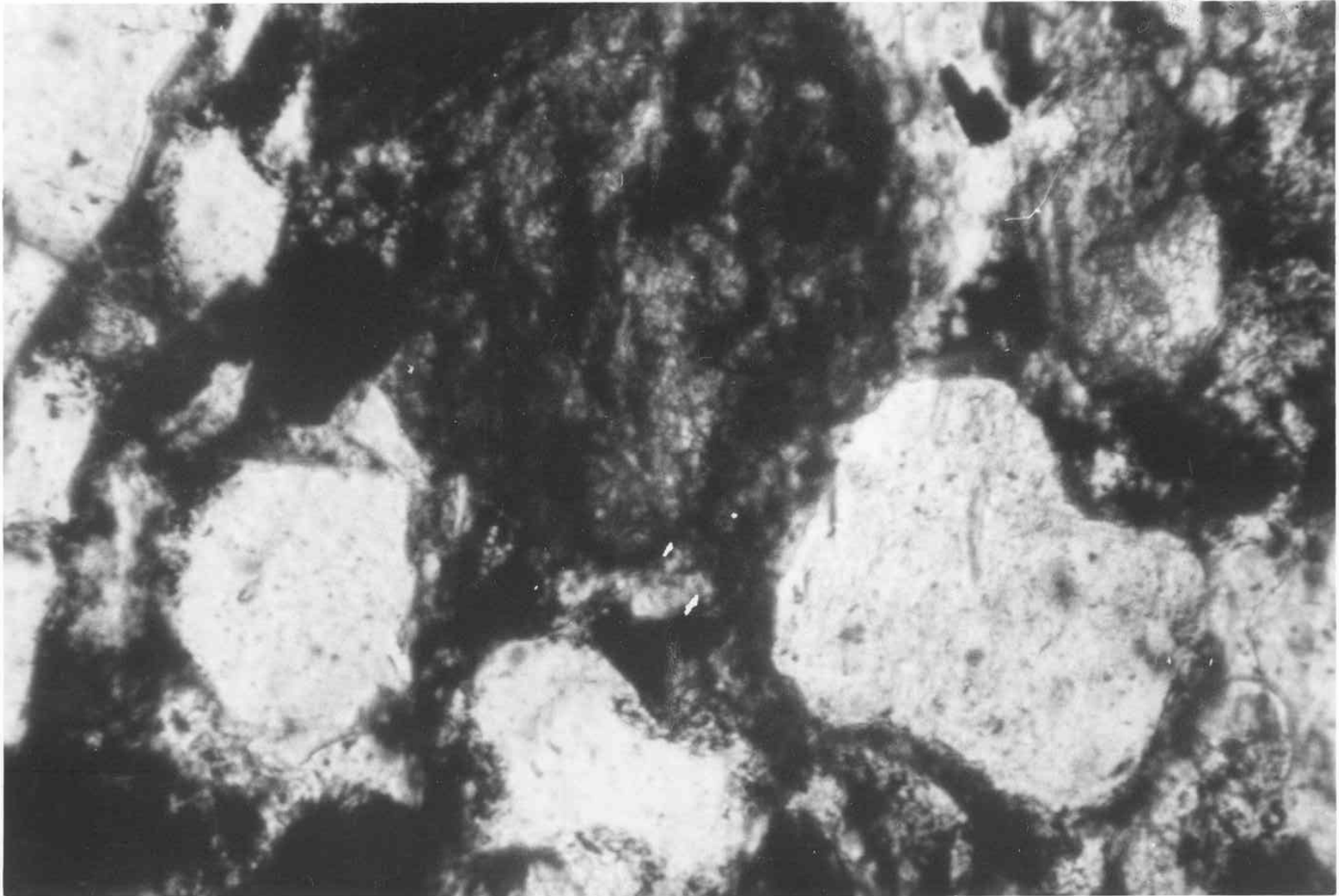
A-33



27 43

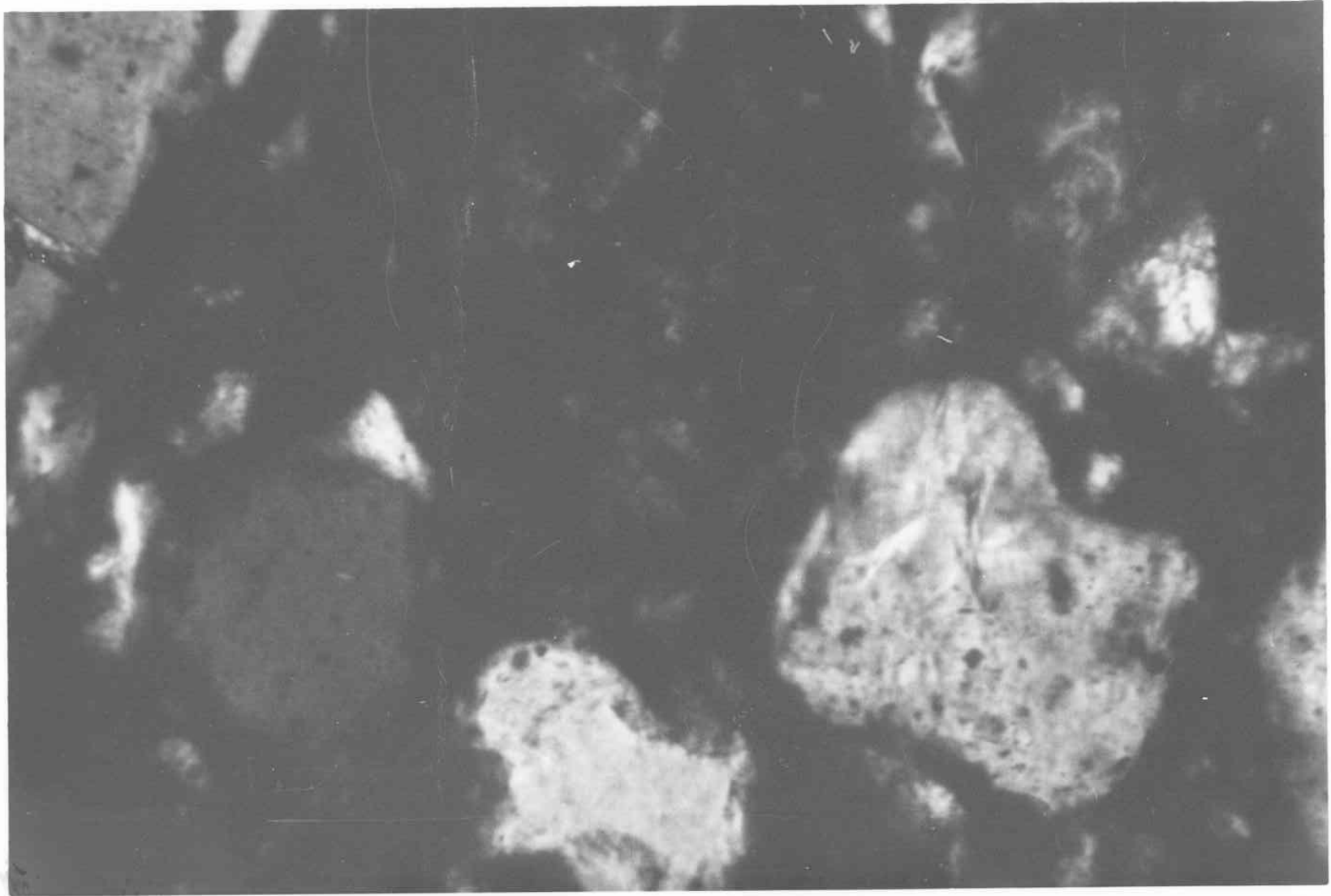
• FEB • 70

A-34

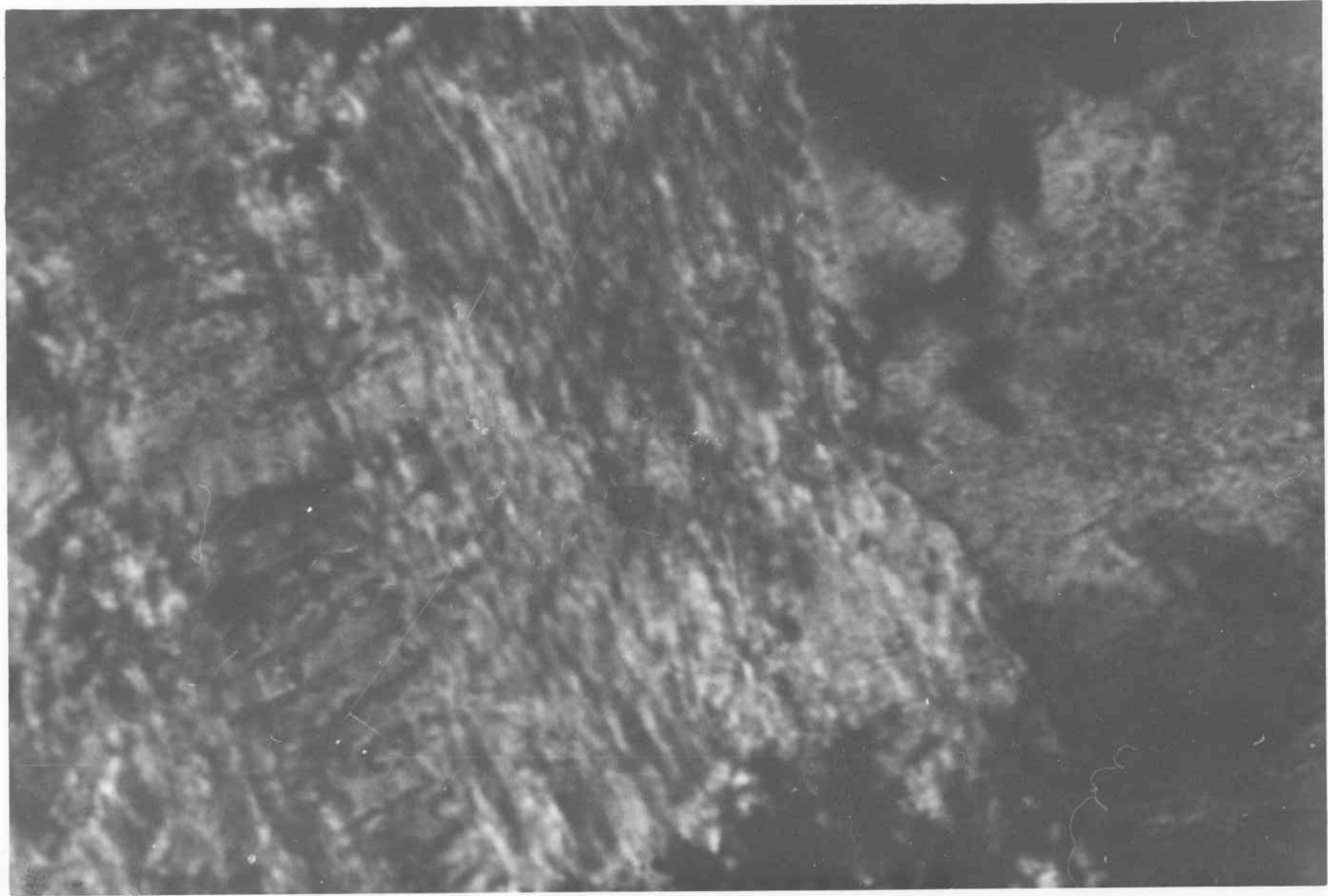


• 111 • 97

A-35



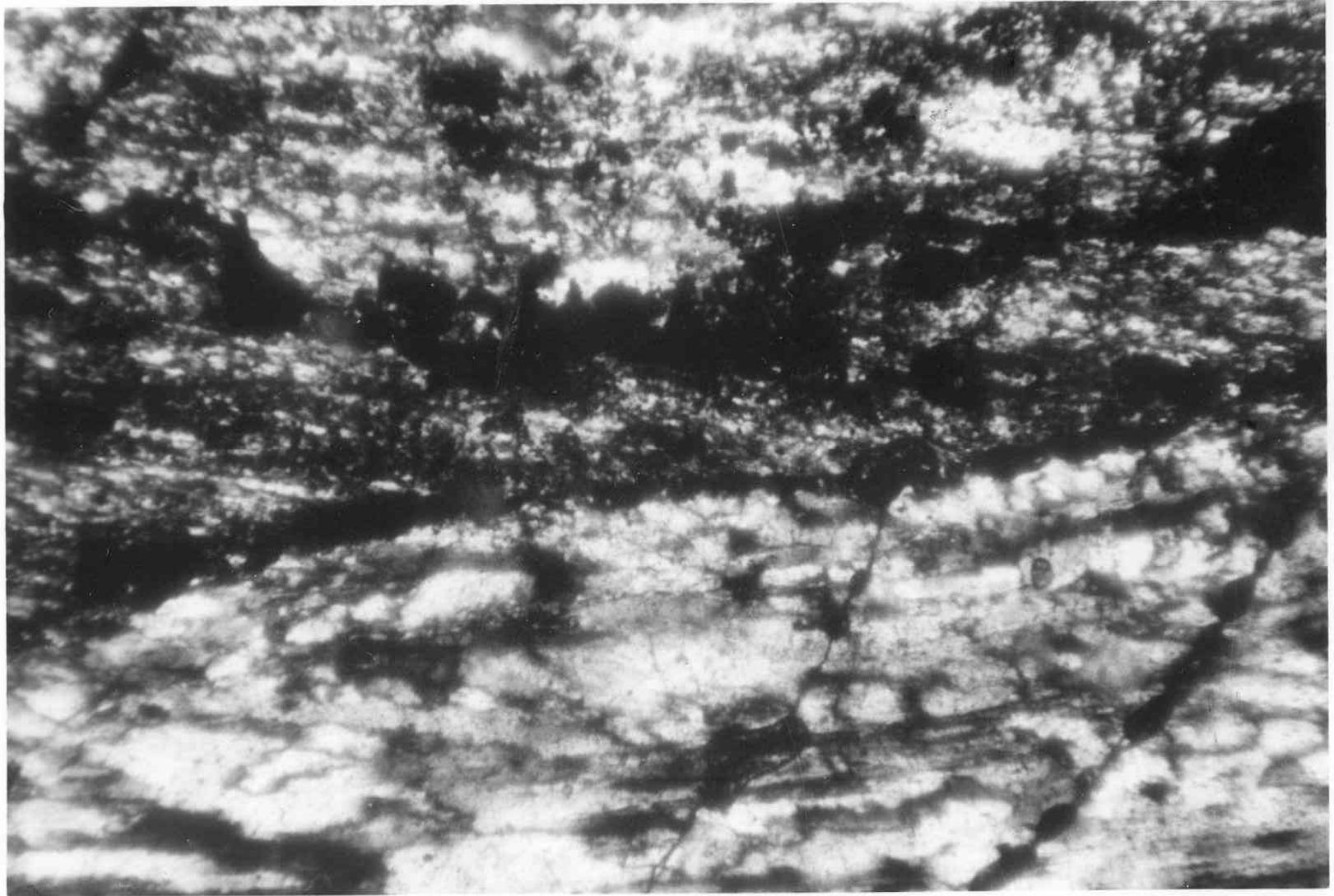
A-36



01 001

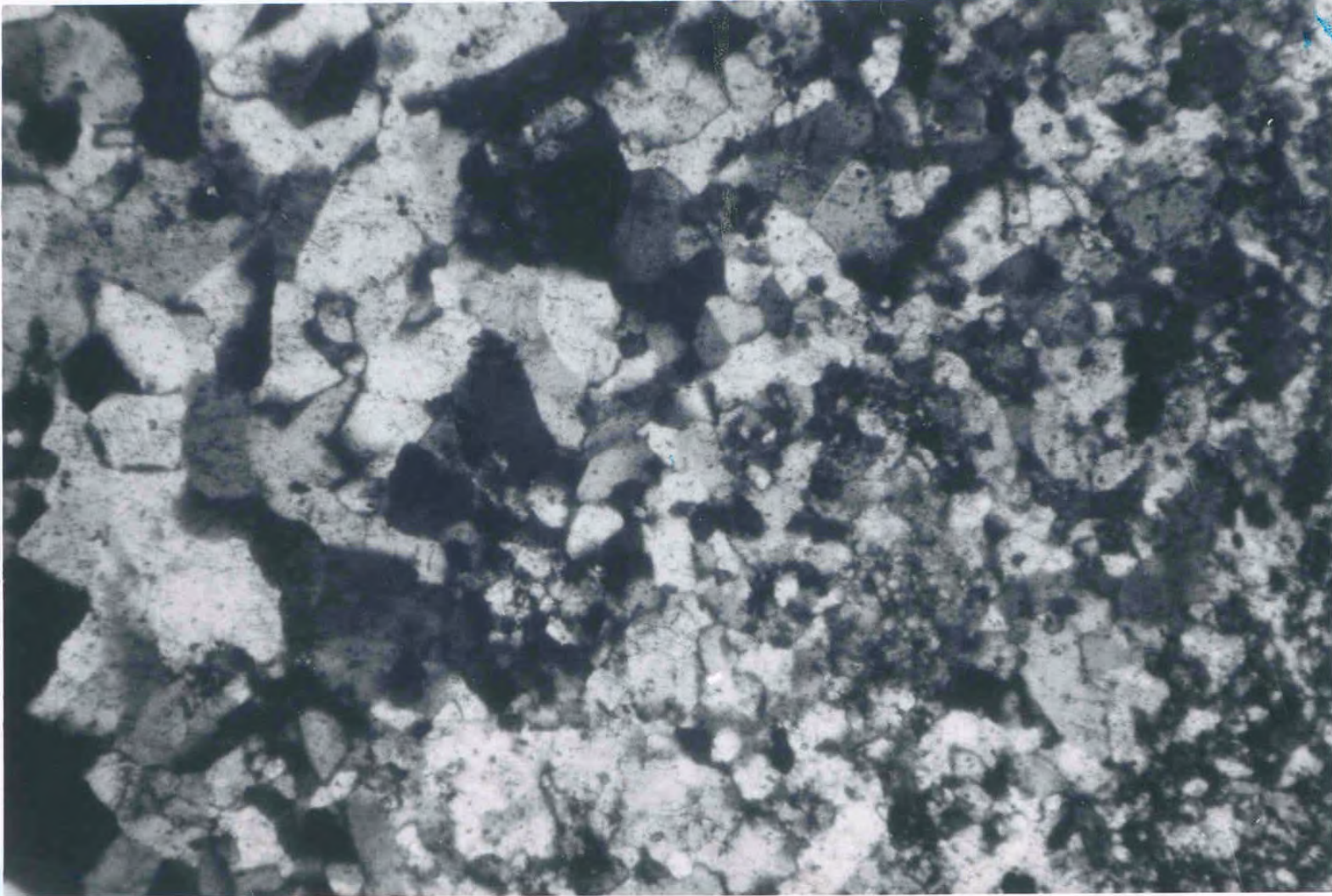


A-37



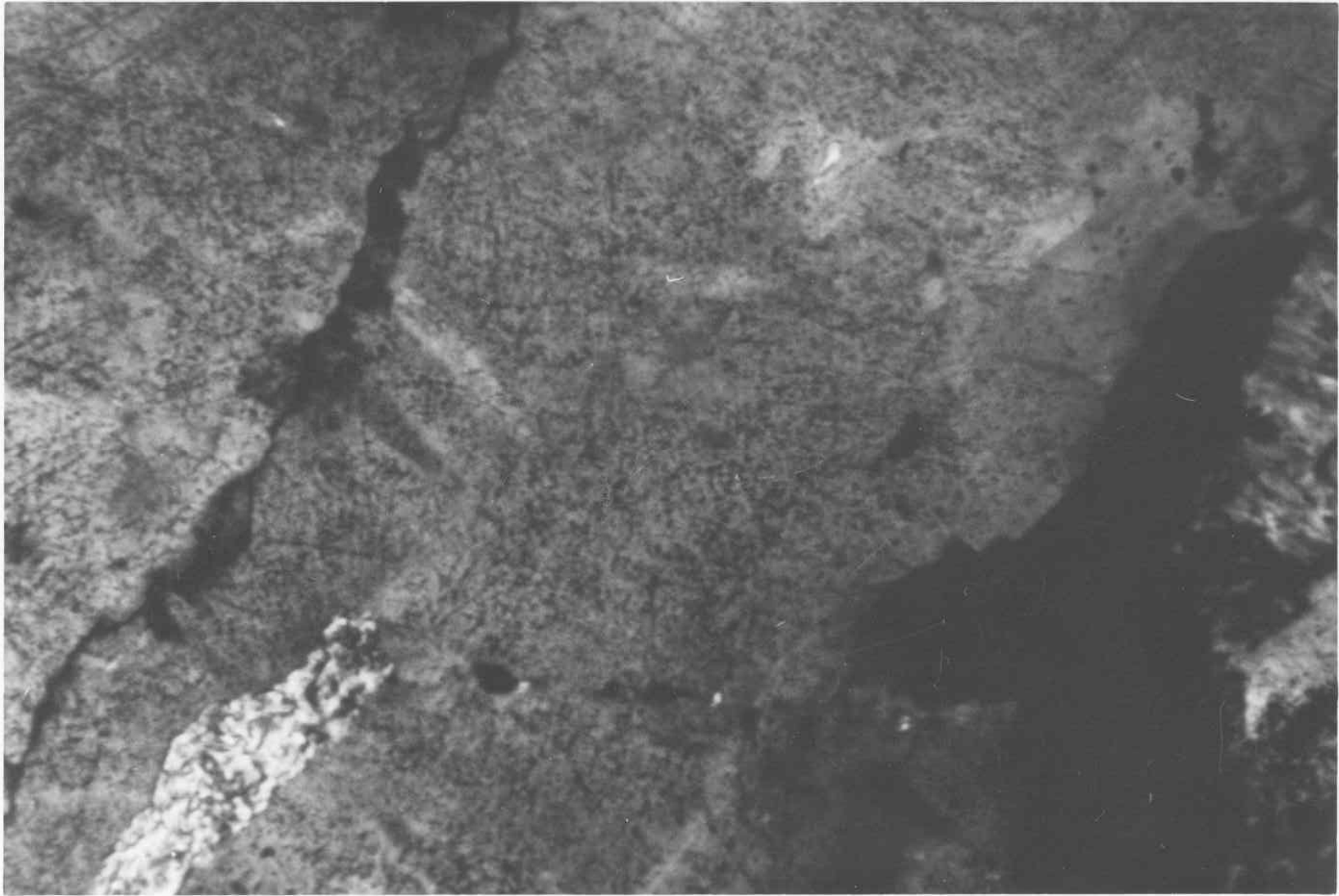
• F E R •

A-38



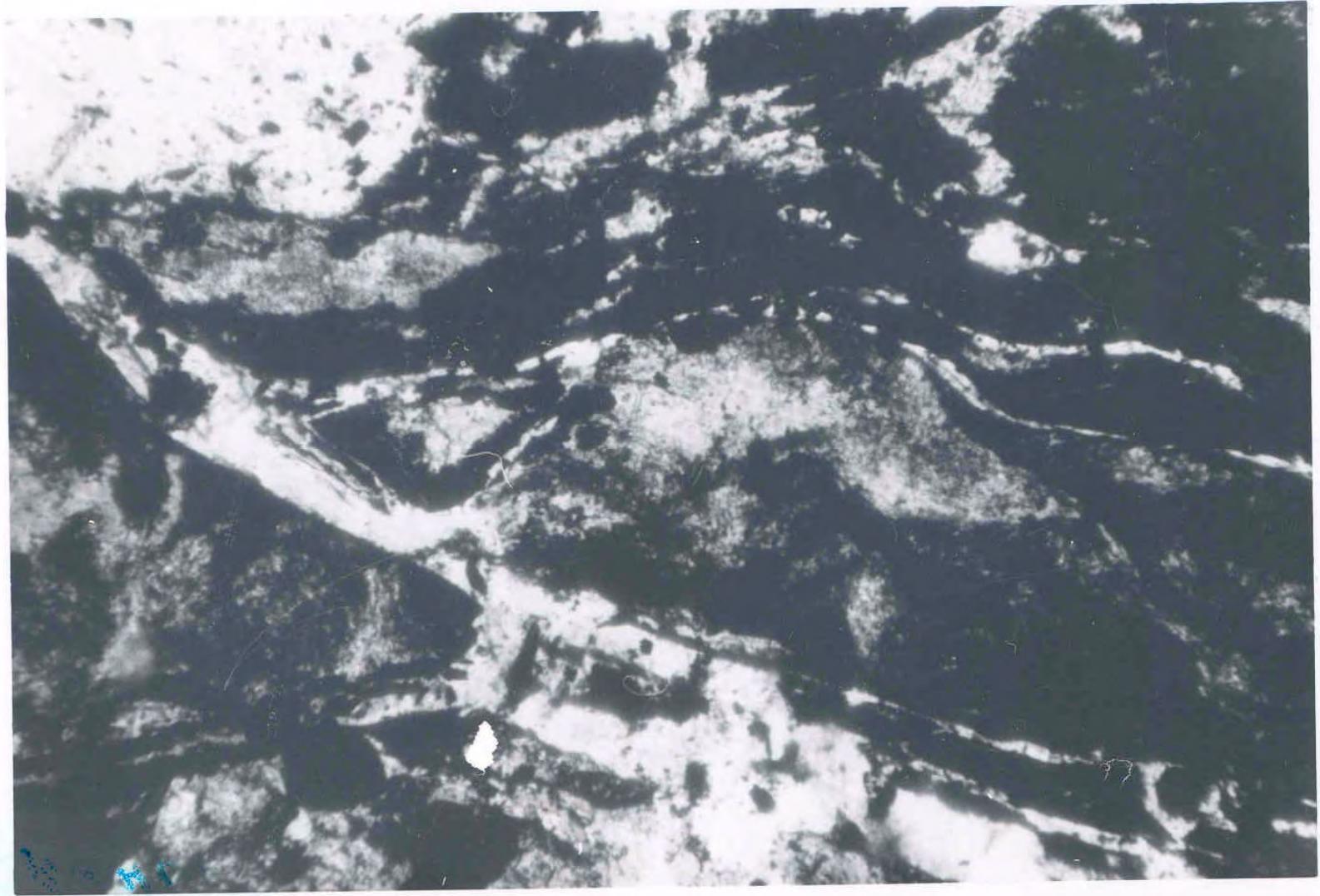
• FEB • 76

A-39



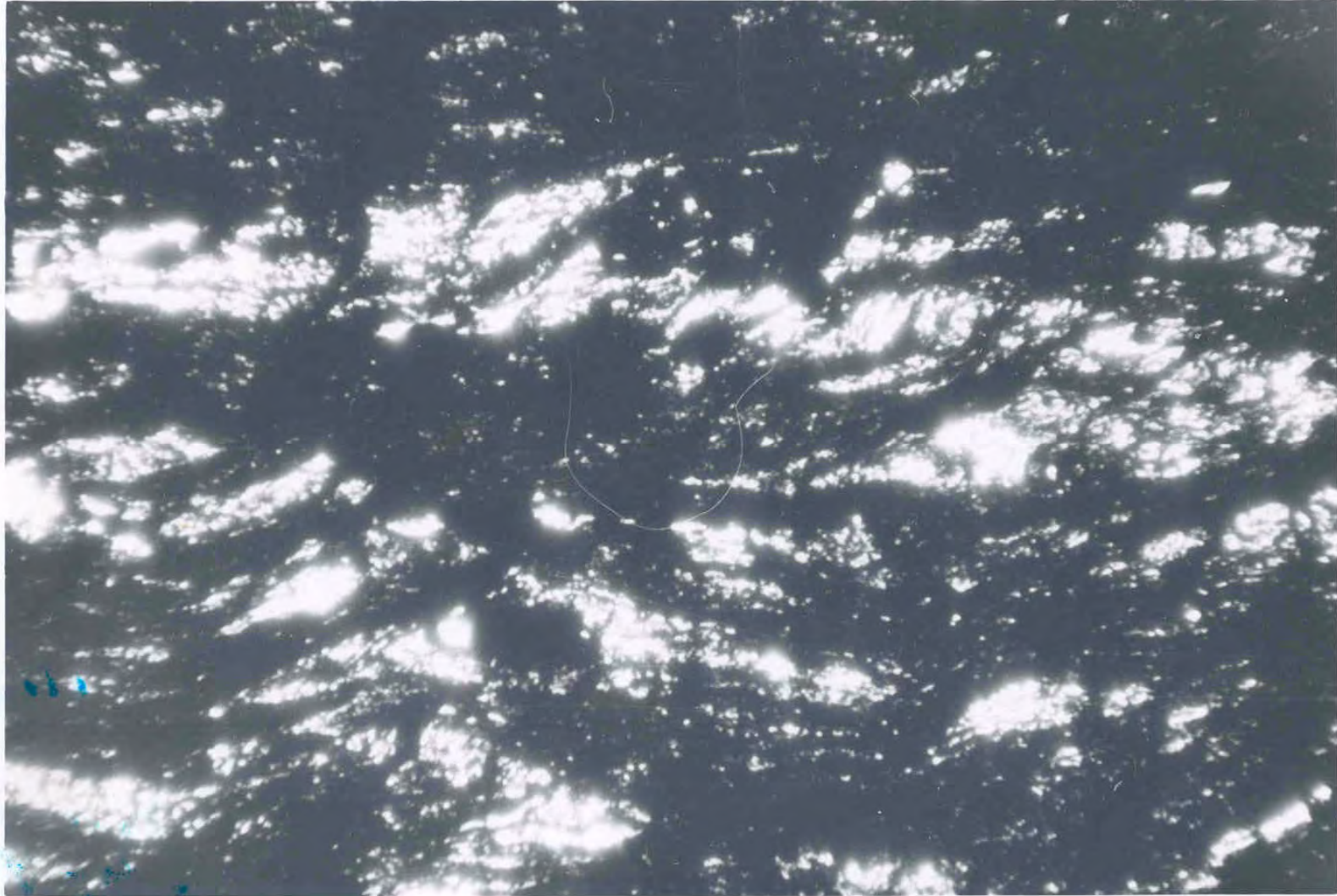


A-40



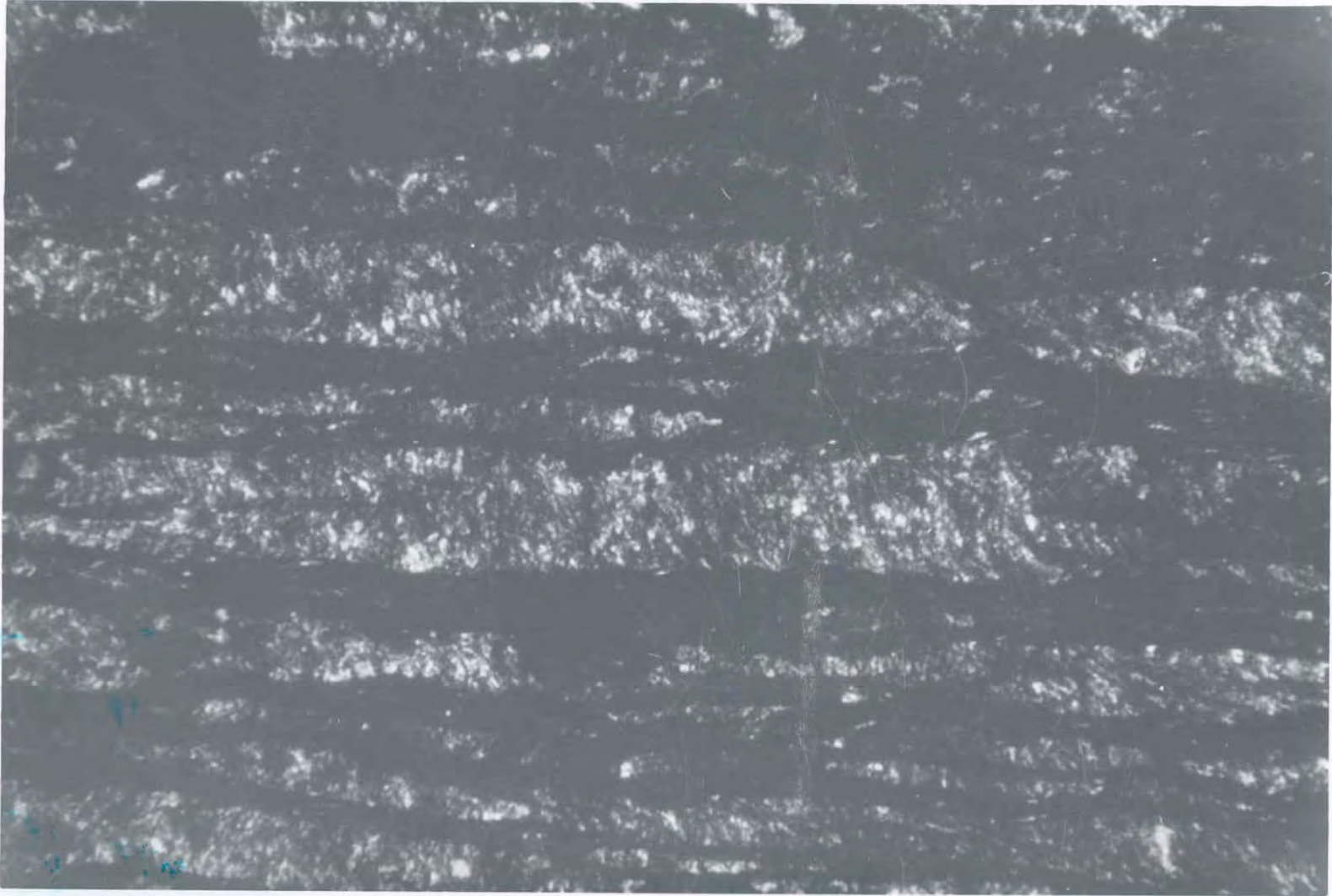
• FEB • 76

A-41



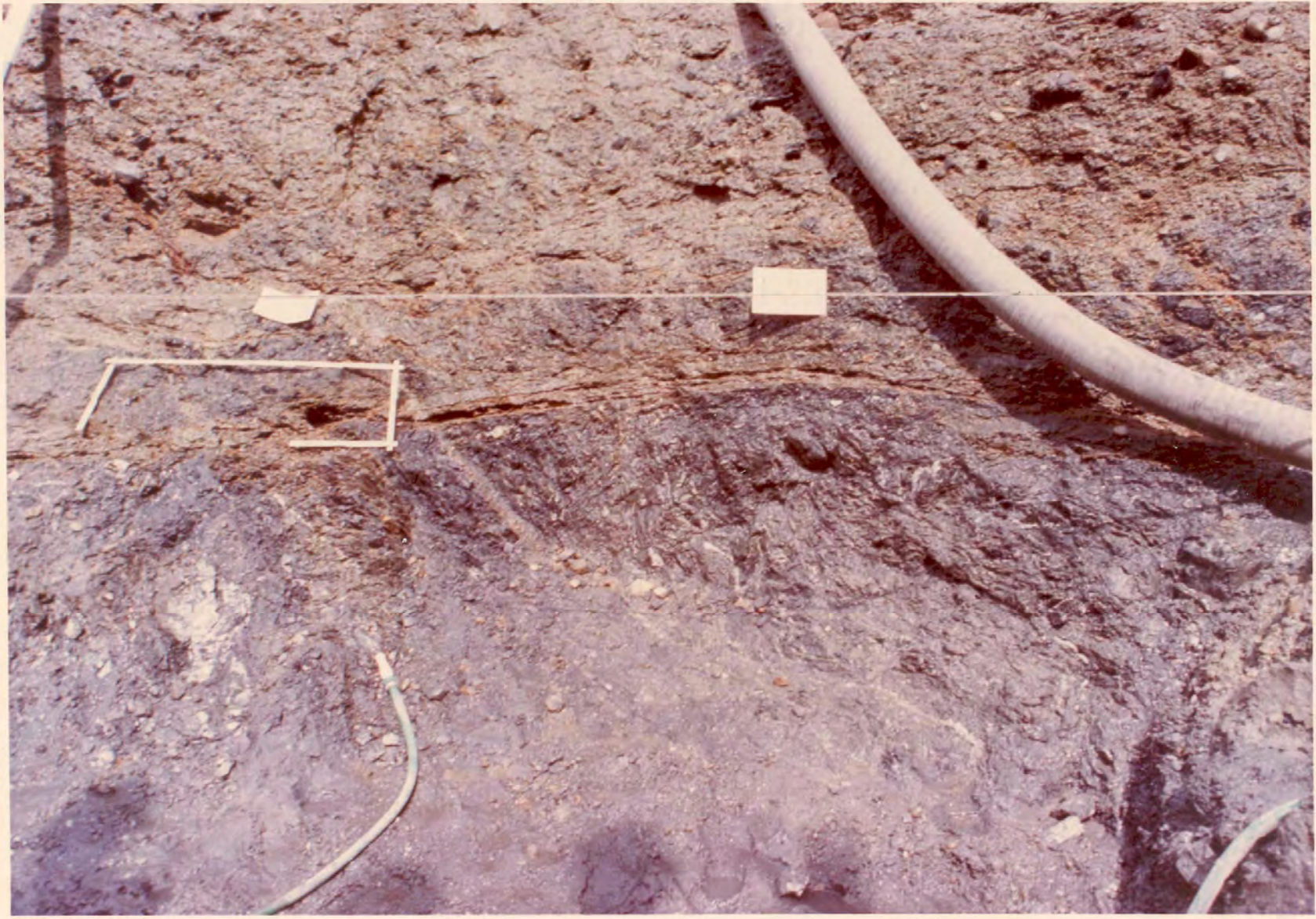


A-42



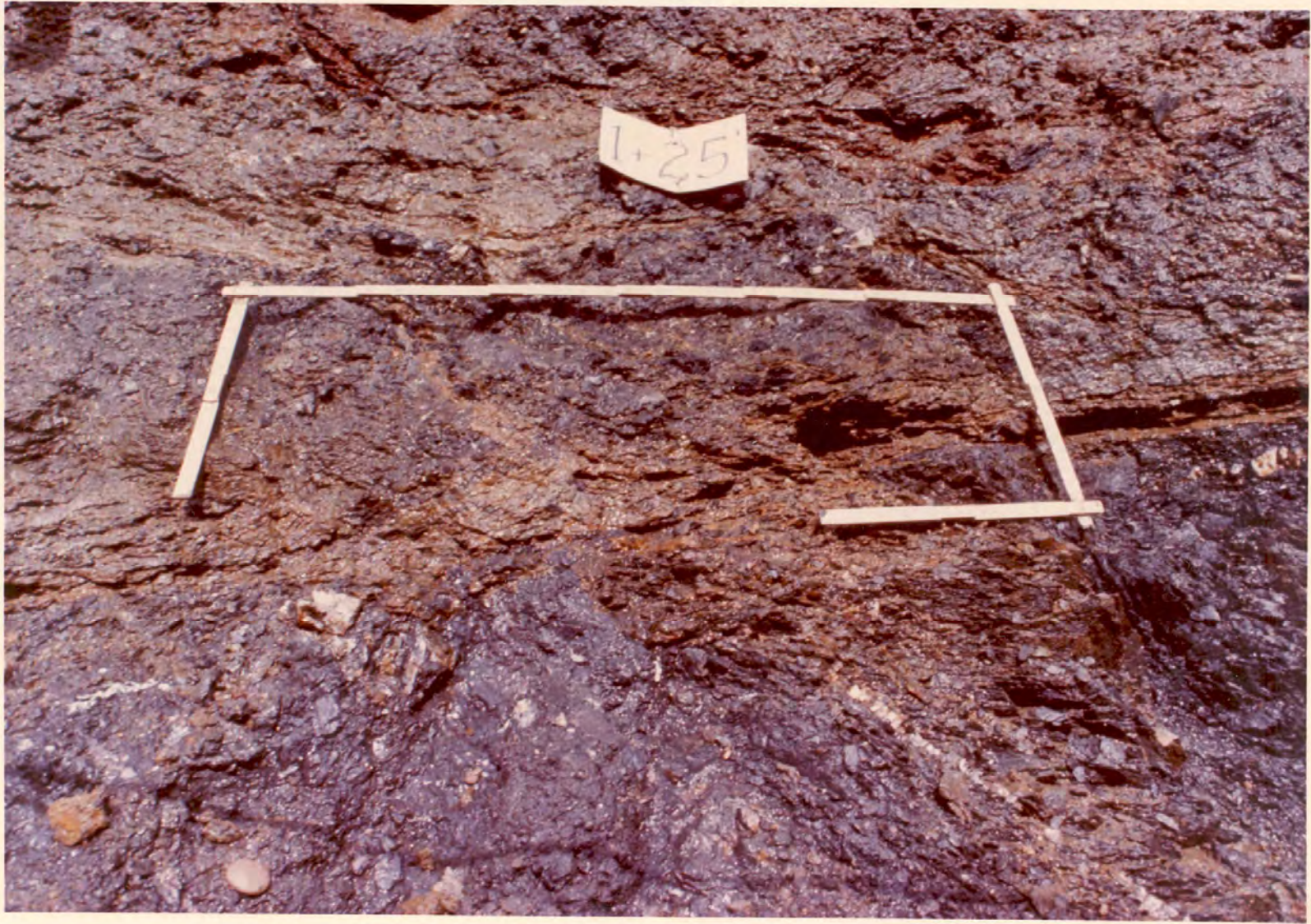


**B-1**



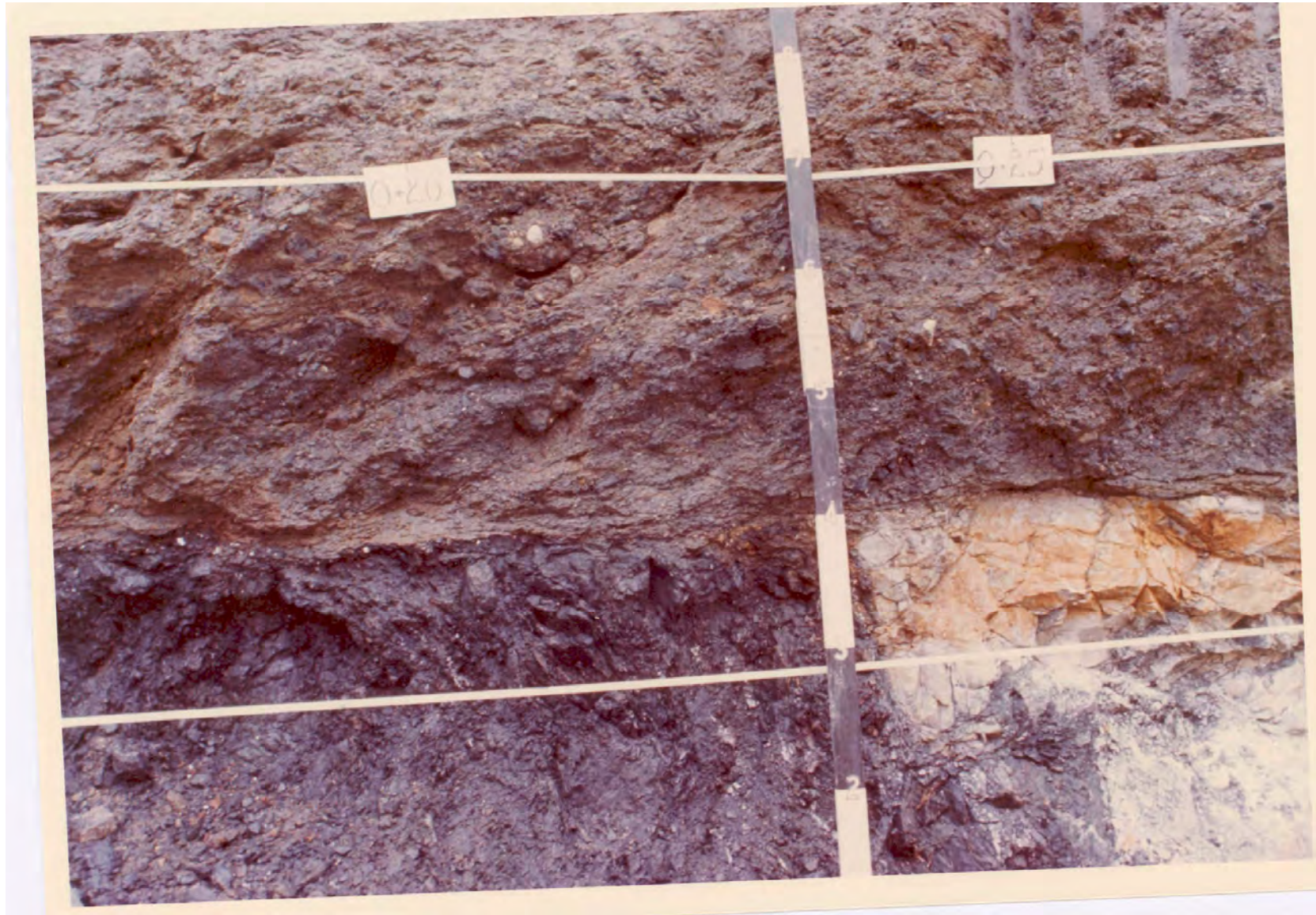


B-2



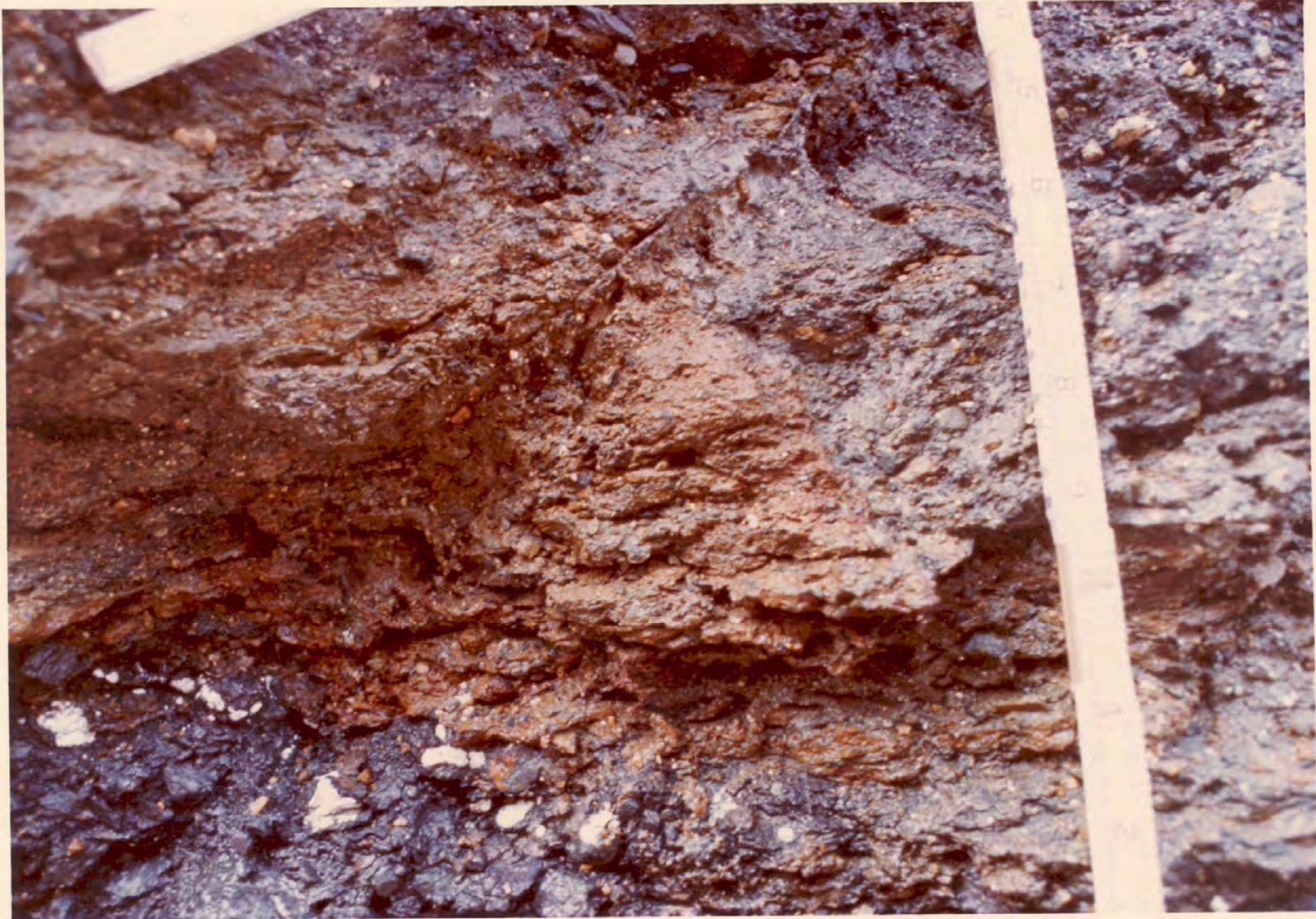


B-3



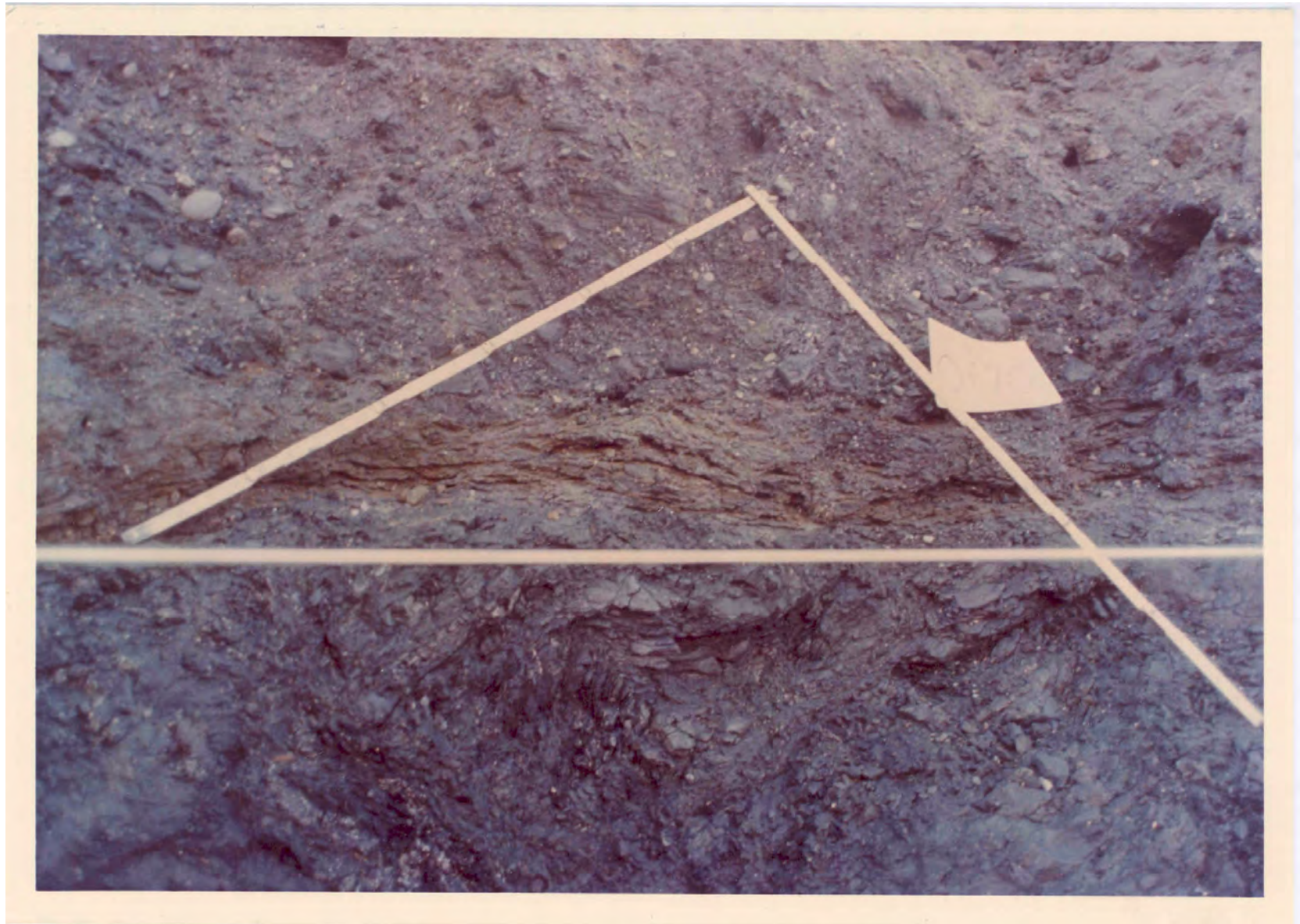


B-4



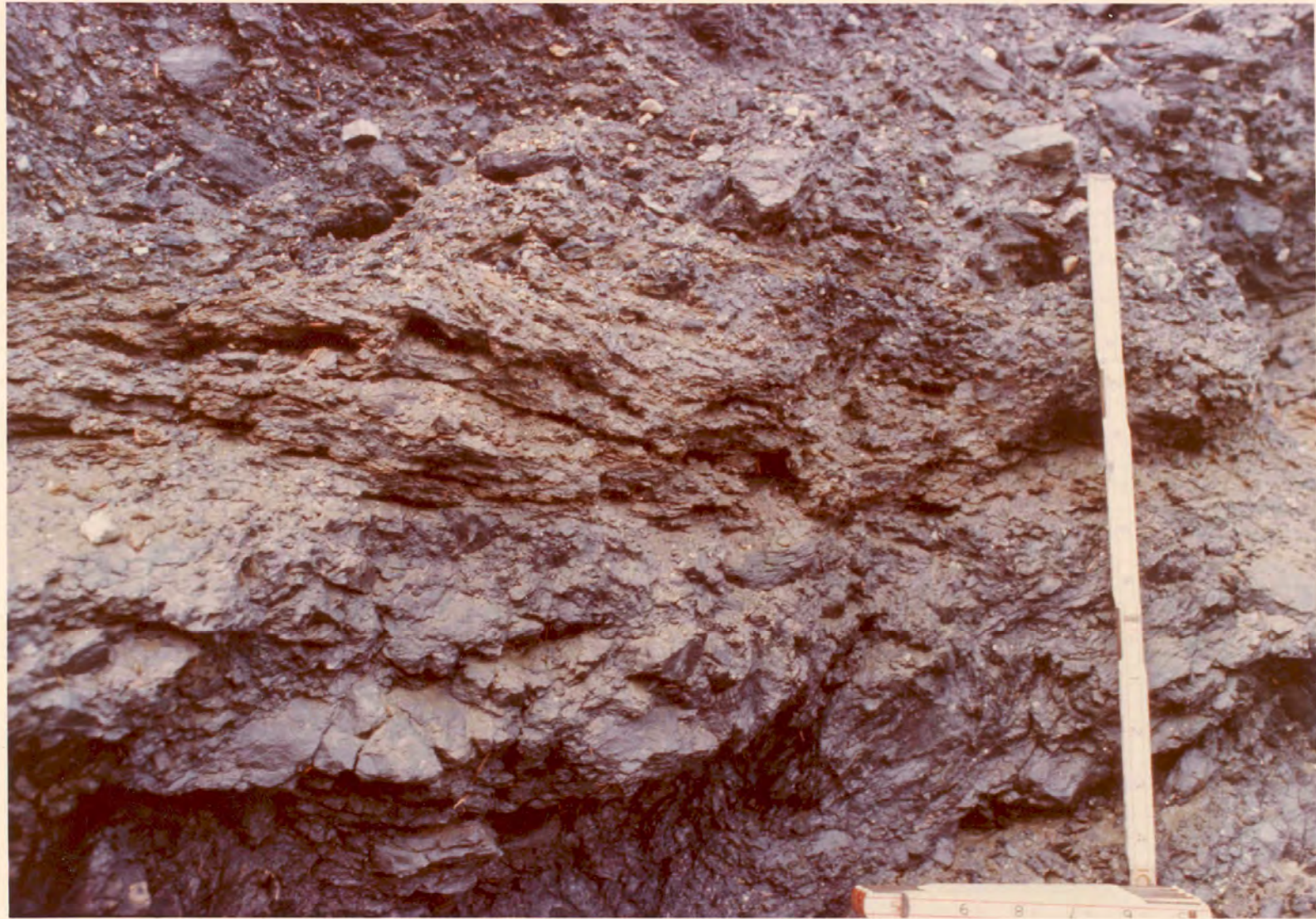


B-5





**B-6**





**B-7**



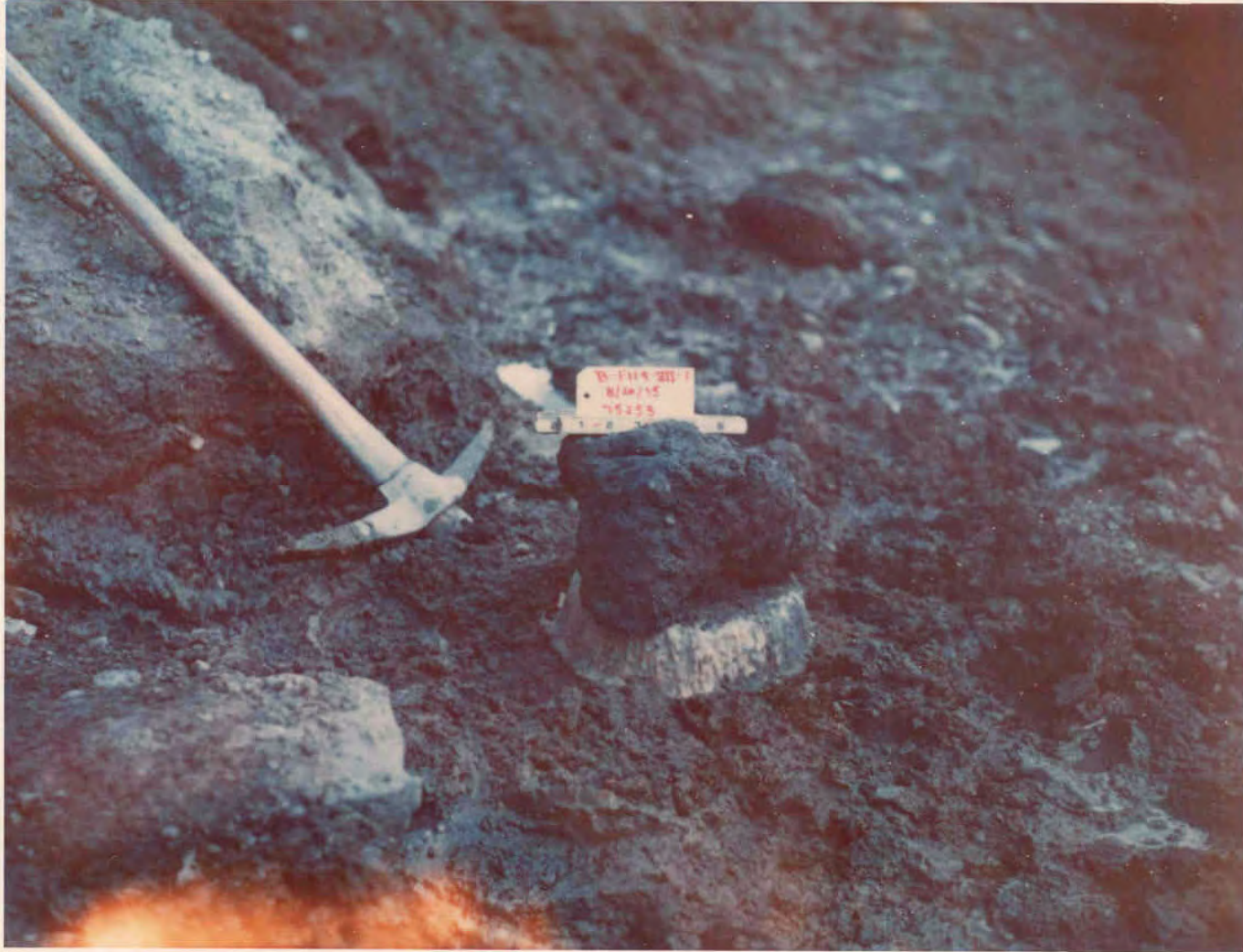


B-8





B-9





B-10

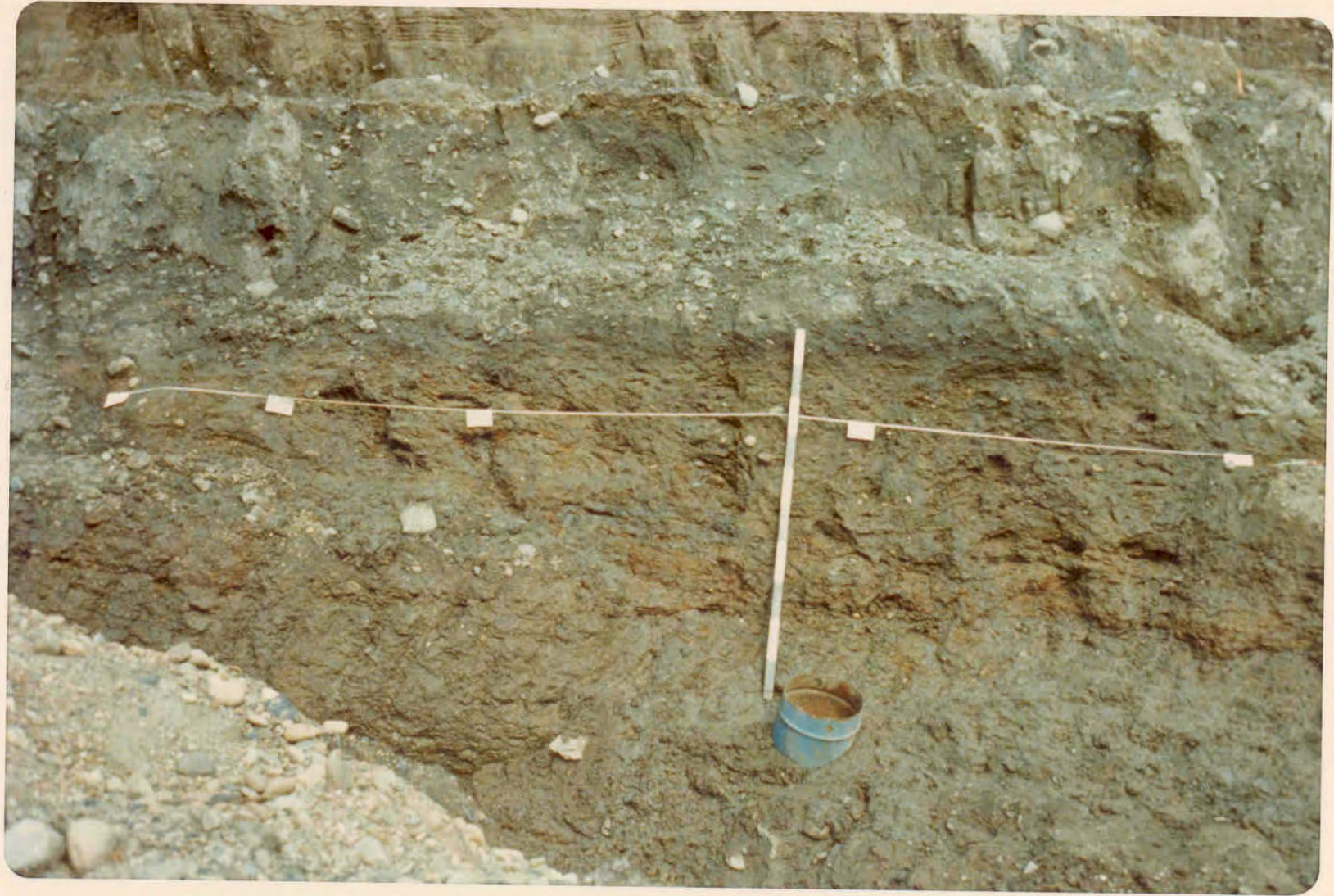


B-11

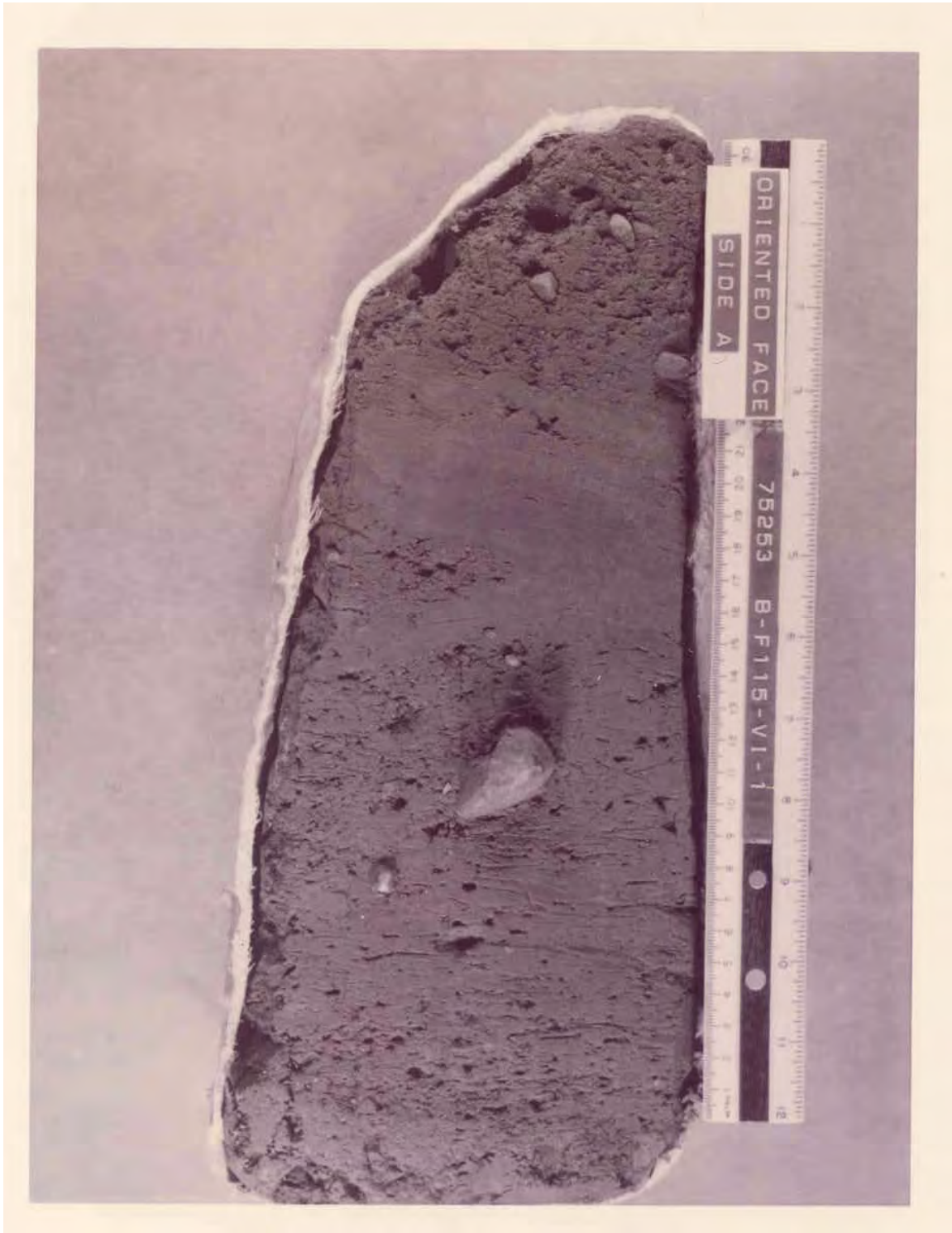




**B-12**



**B-13**



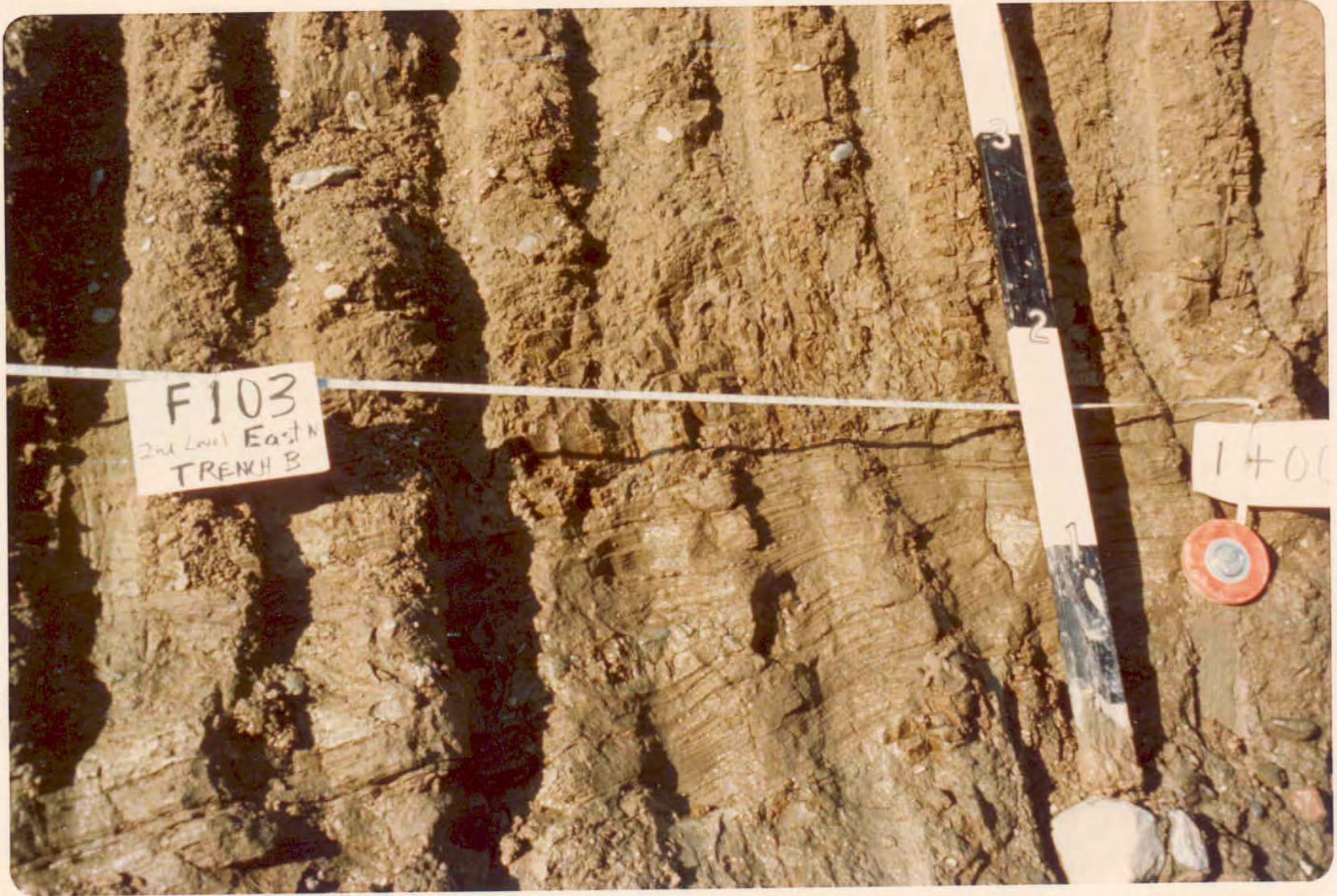


B-14





B-15

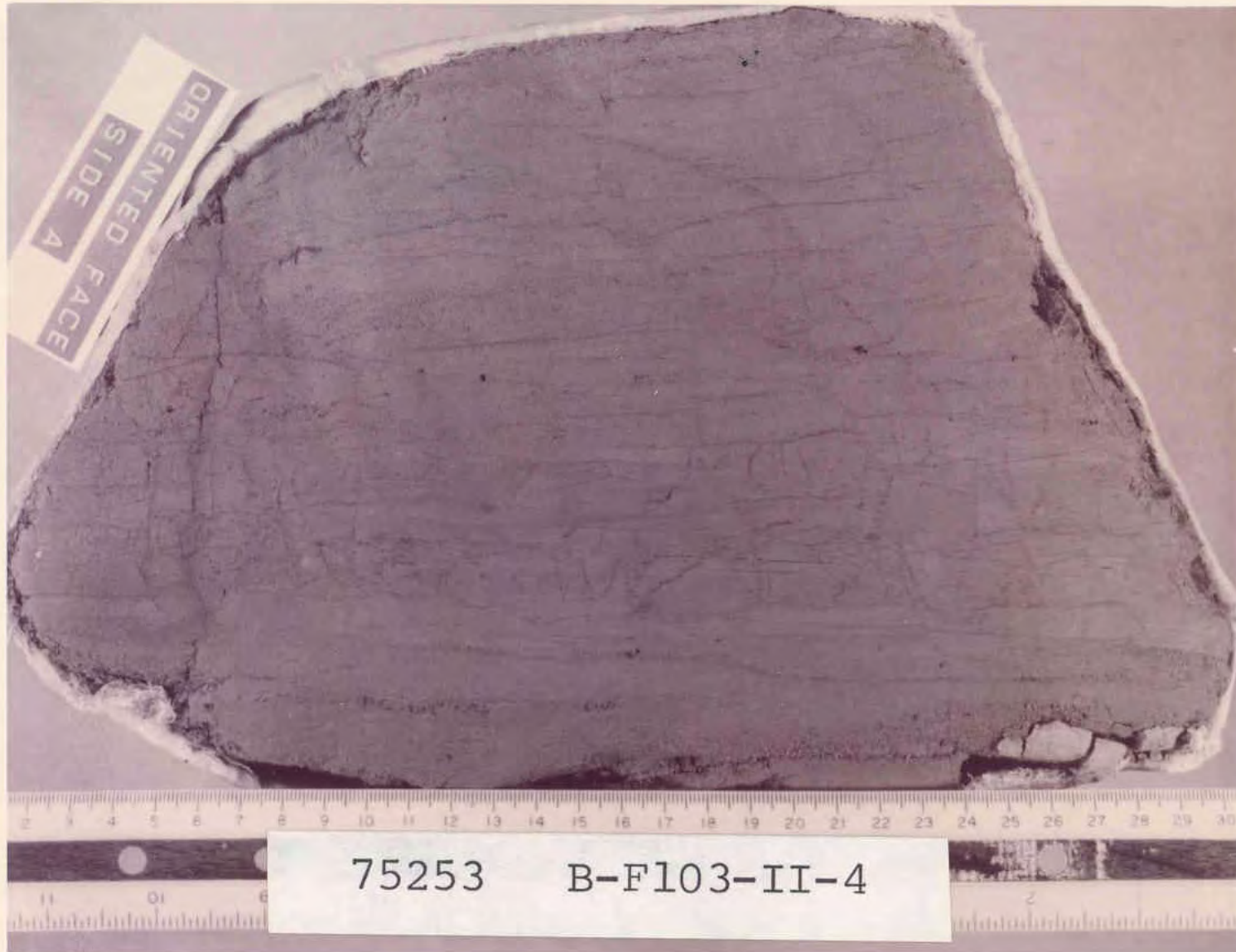




**B-16**

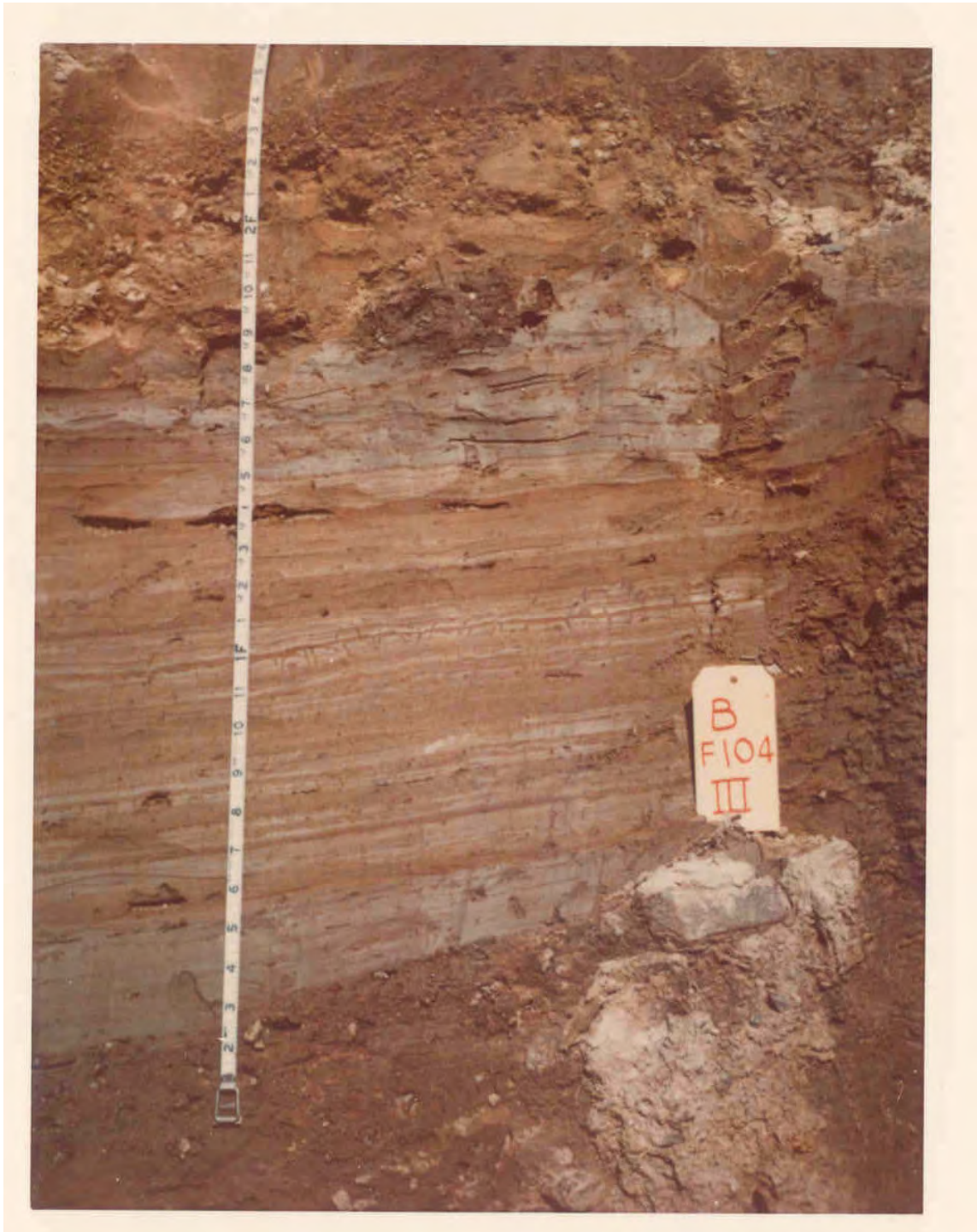


B-17

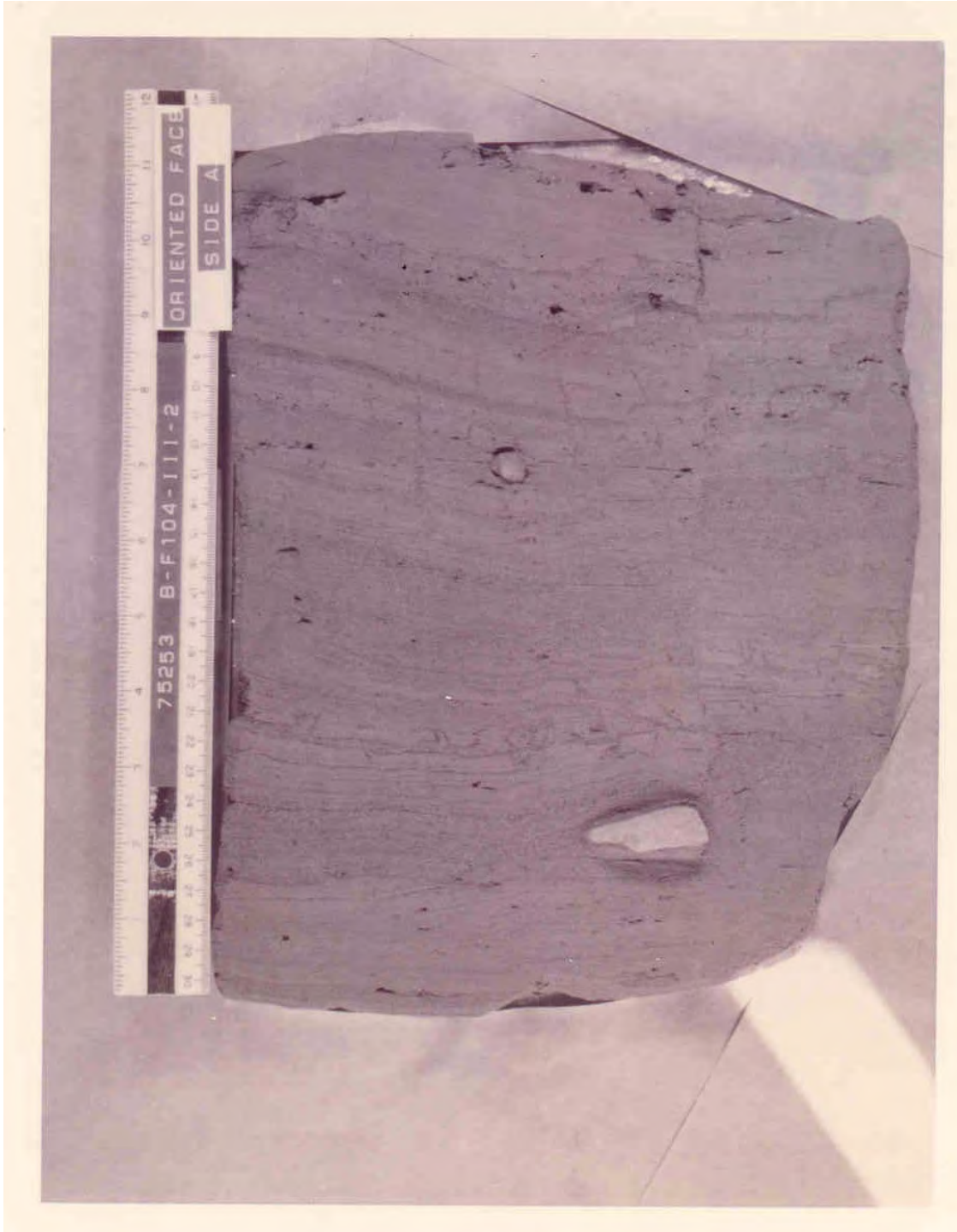




B-18



B-19





B-20





**B-21**





B-22





B-23



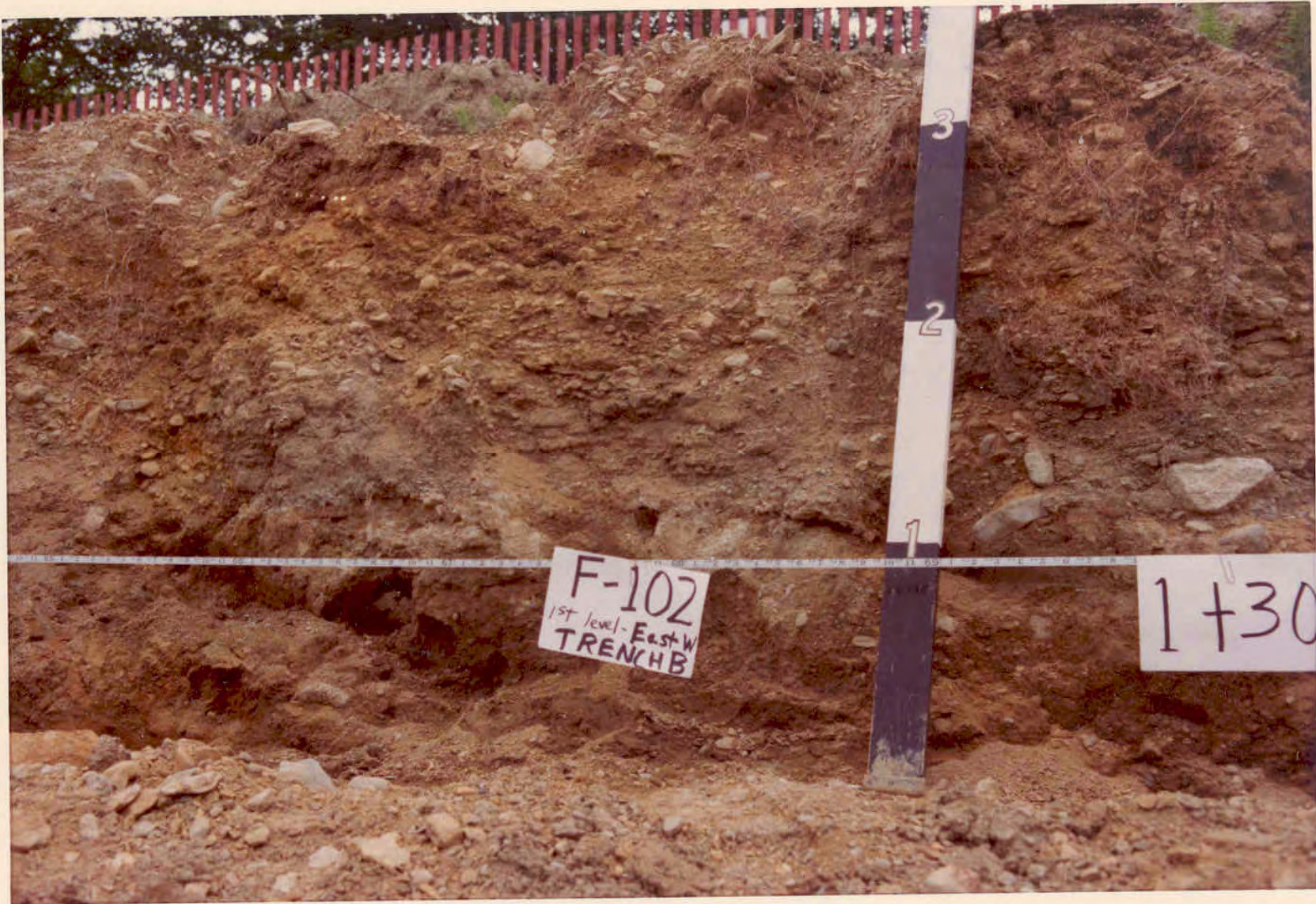


B-24



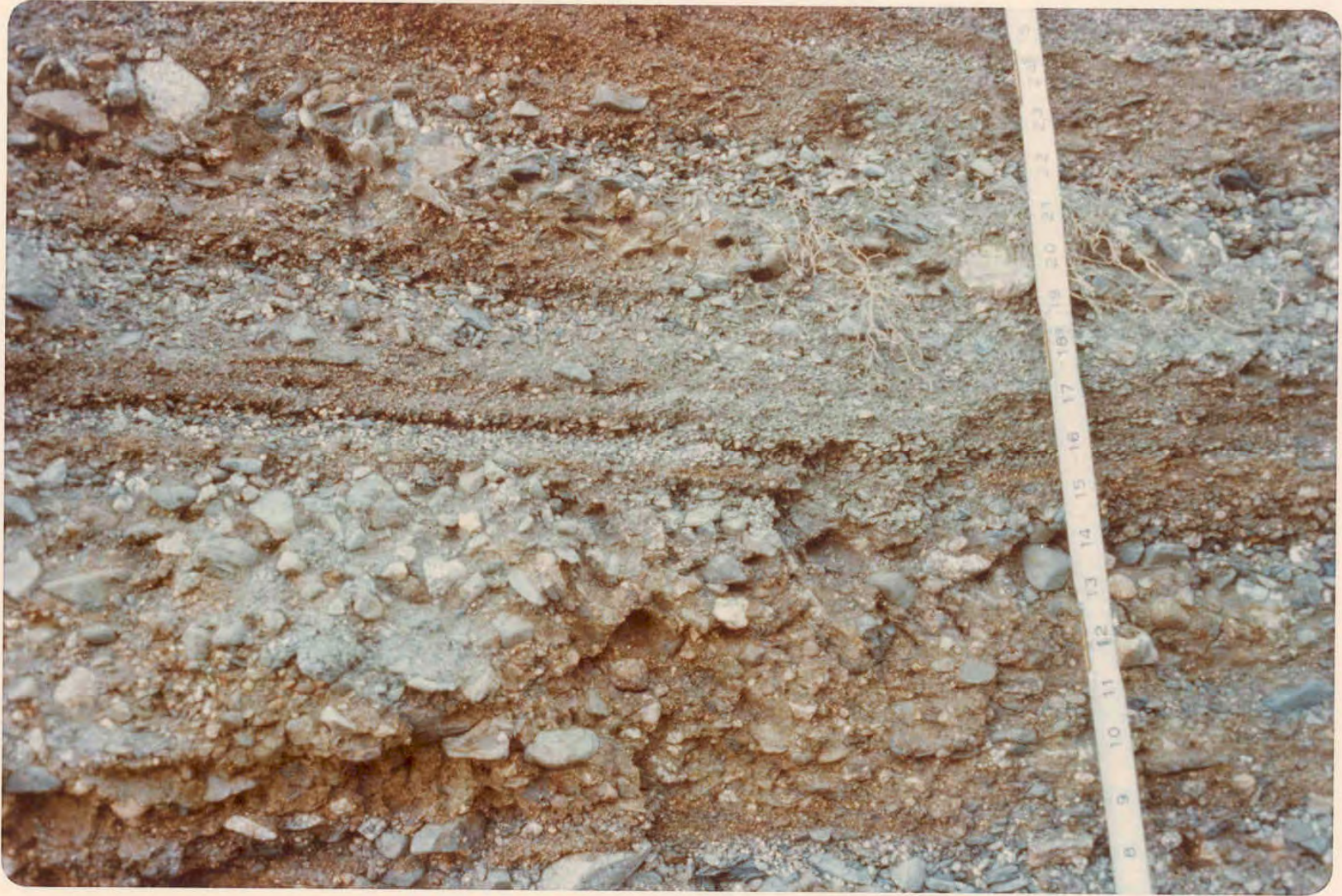


B-25





B-26



APPENDIX C

Material Properties: Graphs and Tables

Contents

<u>Table or Graph #</u>	<u>Description</u>	<u>Page</u>
Table C-1	Specific Gravity Determinations on Materials from Trench B	C-1
Table C-2	Summary of Index Tests on Tills from Trenches A & B	C-2
Table C-3	Water Contents across Rusty Zone in Trench A	C-3a
Table C-4	Densities, Void Ratios, Water Contents and Percent Saturation of Till in Trench A	C-4
Table C-5	Summary of Index Tests on Samples from Trench B	C-5
Table C-6	Summary of Index Tests on "Gouge"-like Extremely Weathered Phyllite	C-6
Table C-7	Location and Description of GEI Samples from Trench B	C-7a
Table C-8	Description of Thin Sections and Grain Mounts of Samples from Trench A	C-8a
Table C-9	Rotation and Direct Shear Tests on Till and "Gouge" from Trench A	C-9a
Table C-10	Description and Location of Tests on Beach Sands on North End of Sears Island and of Outwash in Trench B	C-10a
Graph C-11	Grain Size Curves: Laurentide Lodgment Tills, Trenches A and B	C-11
Graph C-12	Grain Size Curves: Marine Deposits and Old Tills and Outwash, Trench B	C-12
Graph C-13	Grain Size Curves: Soft Gray "Gouge", Trenches A and B	C-13
Graph C-14	Grain Size Curves: Coarse Strata in Upper Outwash, Trench B	C-14
Graph C-15	Grain Size Curves: Fines and More Widely Graded Strata in Upper Outwash, Trench B	C-15
Graph C-16	Grain Size Curves: Beach Deposits on Northeast End of Sears Island	C-16
Graph C-17	Grain Size Curves: Beach Deposits on Northwest End of Sears Island	C-17
Graph C-18	Plasticity Chart: Laurentide Lodgment Tills, Trenches A and B	C-18
Graph C-19	Plasticity Chart: Marine Deposits and Old Outwash/Till, Trench B	C-19
Graph C-20	Plasticity Chart: Soft Gray "Gouge", Trenches A and B	C-20

Table C-1

Specific Gravity Determinations on Materials from Trench B

<u>Sample Location</u>	<u>Specific Gravity of Solids</u>
B-F103-I Upper Till, Olive	2.72
B-F107-IV Lower Till, Gray	2.73
B-F110-V Outwash/Till, Lightly Cemented	2.68
B-F115-VI Lower Till, Gray, Clayey	2.72
B-F114-VII Outwash/Till, Uncemented	2.71
B-CUT-VIII Extremely Weathered Phyllite	2.80

Source: Geotechnical Engineers Inc.

Table C-2

Summary of Index Tests on Tillis from Trenches A and B

TRENCH	SAMPLE NO.	DRY UNIT WT. (pcf)	ATTERBERG LIMITS			WATER CONTENT %	SPECIFIC GRAVITY	DEGREE OF SATURATION, %	%<200 MESH
			LL	PL	PI				
B	B-F103-I	125	24	14	10	8.4	2.72	64	54.7
	Upper Olive till	121				12.0		81	
		122				10.0		70	
B	B-F107-IV	132	21	14	7	8.7	2.73	82	53.9
	Lower gray till	134				8.6		87	
		134				8.9		90	
A	Bag 1 - Gray till	-	26	14	12	-	-	-	47.1(CM-1)
	Bag 2 - Olive till	-	24	15	9	-	-	-	45.2(CM-2)
	Bag 3 - Olive till	-	-	-	-	-	-	-	52.0(CM-3)
A	Bag 4 - Gray till	-	25	16	9	-	-	-	52.9(CM-4)
	Bag 22 - Gray till	*	-	-	-	*	-	*	47.8(CM-15)
A	Bag 23 - Olive till	*	-	-	-	*	-	*	51.5(CM-16)

\* See Table C-3

Source: Geotechnical Engineers Inc.



Table C-3

Water Contents Across Rusty Zone in Trench A  
(Refer to Figure 8)

<u>Water Content Line &amp; Number</u>	<u>Till Color</u>	<u>Water Contents (%)</u>
A-1	Olive	10.8 (12.0)
A-2	Olive	10.1 (12.9)
A-3	Olive	9.6 (12.5)
A-4	Olive	10.1 (12.5)
	<u>"Rusty Crack"</u>	
A-5	Gray	11.0 (11.4)
A-6	Gray	10.5 (11.2)
A-7	Gray	10.9 (11.3)
A-8	Gray	9.2 (10.4)
<hr/>		
B-1	Olive	11.4 (12.0)
B-2	Olive	10.4 (11.9)
B-3	Olive	10.6 (11.8)
	<u>"Rusty Crack"</u>	
B-5	Olive-Gray	10.6 (11.5)
B-6	Olive-Gray	10.0 (10.6)
B-7	Olive-Gray	9.5 (10.3)
B-8	Gray	10.2 (10.7)
<hr/>		
C-1	Gray	11.1 (11.8)
C-2	Gray	10.1 (11.0)
C-3	Gray	10.5 (11.1)
C-4	Gray	11.4 (12.3)
	<u>"Rusty Crack"</u>	
C-5	Olive-Gray	11.3 (12.1)
C-6	Olive-Gray	10.0 (11.2)
C-7	Olive-Gray	10.3 (12.2)
C-8	Gray	11.5 (12.6)

Table C-3 (Continued)

<u>Water Content Line &amp; Number</u>	<u>Till Color</u>	<u>Water Contents , %</u>
C-9	Gray	10.3 (12.0)
C-10	Dark Gray	8.5 ( 9.8)
<hr/>		
D-1	Not Noted	7.8
D-2	Not Noted	10.3
D-3	Not Noted	9.4
D-4	Not Noted	9.9
D-5	Not Noted	9.2
D-6	Not Noted	11.1
D-7	Not Noted	9.5
D-8	Not Noted	10.2
D-9	Not Noted	9.5
D-10	Not Noted	10.2

Note: Water Contents in ( ) were computed on -#4 sieve fraction only.

Source: Geotechnical Engineers Inc.

Table C-4

Densities, Void Ratios, Water Contents and  
Percent Saturation of Till in Trench A

<u>Sample Bag</u>	<u>Total Unit Wt. lb/ft<sup>3</sup></u>	<u>Water Content %</u>	<u>Void Ratio*</u>	<u>Dry Unit Weight, lb/ft<sup>3</sup></u>	<u>Percent Saturation</u>
Bag 22 (Gray)	146.6	9.1	0.254	134.4	96.7
Bag 22 (Gray)	146.1	8.9	0.257	134.2	93.5
Bag 22 (Gray)	145.2	9.2	0.268	133.0	92.7
Bag 22 (Gray)	146.3	8.6	0.251	134.7	85.8
Bag 22 (Gray)	146.5	9.4	0.259	133.9	98.0
Bag 22 (Gray)	146.6	9.4	0.258	134.0	98.4
Bag 22 (Gray)	147.1	8.9	0.249	135.1	96.5
<hr/>					
Bag 23 (Olive)	143.4	9.1	0.282	131.4	87.1
Bag 23 (Olive)	142.8	10.7	0.307	130.0	94.1
Bag 23 (Olive)	143.1	10.3	0.299	129.7	93.0
Bag 23 (Olive)	146.2	9.2	0.259	133.9	95.9
Bag 23 (Olive)	143.6	9.9	0.291	130.7	91.8
Bag 23 (Olive)	142.6	10.1	0.302	129.5	90.3
Bag 23 (Olive)	145.0	10.3	0.282	131.5	98.6
Average: Bag 22(Gray)	146.3	9.1	0.257	134.2	94.5
Average: Bag 23(Olive)	143.8	9.9	0.289	131.0	93.0

\* Specific Gravity was assumed to be 2.70

Source: Geotechnical Engineers Inc.

Table C-5

## Summary of Index Tests on Samples from Trench B

TRENCH	SAMPLE NO.	DRY UNIT WT. (pcf)	ATTERBERG LIMITS			WATER CONTENT (%)	SPECIFIC GRAVITY	DEGREE OF SATURATION (%)	% <200 MESH
			LL	PL	PI				
B	F-103-II Blocky water-laid deposit	105 108 107	24	11	13	19.4 18.5 18.9	-	-	91.3
B	F-104-III Laminated silts and fine sand	103 105 102	31	16	15	23.3 20.9 22.3	-	-	47.5
B	F-110-V-1 Outwash-till lightly cemented	127 122 120	Nonplastic			8.5 9.0 8.8	2.68	72 65 60	51.9
B	F-110-V-2 Outwash-till lightly cemented	124* 139 121	Nonplastic			11.0* 6.5 12.7	2.68	85 86 89	40.8
B	F-110-V-3 Outwash-till lightly cemented	131 131 129	Nonplastic			9.6 9.7 9.6	2.68	93 94 87	33.4
B	F-115-VI Lower till, gray, clayey	111(top) 119(mid) 124(bot)	22	12	10	18.8 13.8 12.8	2.72	97 88 94	74.5
B	F-114-VII Outwash-till uncemented	129 133 126	18	14	4	9.8 9.4 11.1	2.71	85 94 88	33.7

\*Sample contained a large piece of phyllite.  
Source: Geotechnical Engineers Inc.



Table C-6

Summary of Index Tests on "Couge"-like Extremely Weathered Phyllite

TRENCH	SAMPLE NO.	DRY UNIT WT. (pcf)	ATTERBERG LIMITS			WATER CONTENT (%)	SPECIFIC GRAVITY	DEGREE OF SATURATION (%)	% <200 MESH
			LL	PL	PI				
A	4 (See Fig.8)	-	Limits not determined			15.7	-	-	51.2
A	8 (Near F-2)	-	26	14	12	13.0	-	-	49.5
A	40 (Near F-2)	-	26	14	12	14.5	-	-	55.3
A	C19 (See Fig.8)	-	-	-	-	10.0	-	-	26.5
A	D 6 (See Fig.8)	-	27	15	12	16.1	-	-	56.5
A	F28 (See Fig.8)	-	-	-	-	7.5	-	-	14.0
B	B-CUT-VIII	102	45	27	18	23.8	2.80	93	79.8
		101				22.6		87	
		103				22.6		91	

Source: Geotechnical Engineers Inc.

Table C-7

Location and Description of GEI Samples from Trench B  
(Refer to Figure 9)

<u>Sample Location</u>	<u>Location</u>	<u>Description</u>
B-F103-I (Unit 3)	See Fig. 9 for location in face of Trench B. This location was in the stratum of glacial till that overlies the water-laid deposits found in Trench B. Part of this stratum appeared to have been altered by oxidation from above. The samples taken were from a zone below the apparent effects of oxidation, i.e., in the grayer-colored zone below the upper more brownish zone. The till stratum reached its greatest thickness at the point where the samples were taken. About 10 ft. to the south of the sample location, the water-laid deposits disappear.	Yellowish-brown, slightly gravelly clayey silty sand. (Till) Widely graded; gravel particles up to about 50 mm size; grains are bulky with subangular to subrounded edges; some coarse gravel particles are moderately to severely weathered; slow reaction to shaking test; medium to high dry strength; fines are slightly plastic; noted a somewhat blocky and brittle structure; the sample tends to break into small irregularly shaped blocks 20 to 60 mm thick.
B-F103-II (Unit 4)	The samples were taken in the water-laid deposit that exhibited a blocky structure. The sample location is in the center portion of the east face of Trench B, 20 feet north	Light brown, clayey silt. Low plasticity; low toughness; very slow reaction to shaking test; has an extremely blocky and brittle structure with numerous limonite-stained

Table C-7 (Continued)

<u>Sample Location</u>	<u>Location</u>	<u>Description</u>
B-F103-II (Continued)	of the south end of the water-laid deposit. Till overlies and underlays this water-laid stratum.	joints, some of which are orthogonal; vertical joints are spaced at 10 to 20 mm, horizontal joints are spaced at 5 to 10 mm; gravel particles to about 15 mm; particles are bulky and subangular; layer 35 mm thick at the bottom and 15 mm thick at the top with interlayered gray brown sandy silt 2 to 10 mm thick, and fine uniform sand 10 to 20 mm thick.
B-F104-III (Unit 4)	The same water-laid deposit as at Location B-F103-II but at a lower elevation.	Interbedded gray sandy clayey silt and brown silty fine sand; silty sand layers are from 1 to 10 mm thick, clayey silt layers are from 1 to 40 mm thick; clayey silt layers have low plasticity with a slight reaction to shaking test; sand grains are subrounded to subangular. Sand layers are fine sand, uniformly graded, with a trace of medium to coarse sand and occasional fine to coarse gravel particles up to 20 mm in size; larger particles are subrounded; total sample contains frequent sand partings and occasional fine sand lenses from 1 x 25 mm to 7 x 18 mm in size. A vertical

Table C-7 (Continued)

<u>Sample Location</u>	<u>Location</u>	<u>Description</u>
B-F104-III (Continued)		shear surface was observed striking in a north-south direction with maximum displacements of approximately 20 mm; some contortion in the bedding was observed and occasional particles of mica were observed. (SP- and ML). Grain size curves are shown for a clayey silt and for a silty fine sand layer.
B-F107-IV (Unit 5)	The samples were taken in the olive till that lies below the water-laid deposit and above the gray till. The sample location is approximately 5 feet below the bottom of the water-laid deposit.	Olive slightly gravelly and slightly clayey silty sand (Till). Widely graded; 5% fine to coarse gravel up to about 35 mm in size; particles are subrounded to subangular; slow reaction to shaking test; fines have very low plasticity; noted some local pockets of a more plastic silt (SM).
B-F110-V (Unit 8)	The samples were taken in the granular material that lies above the bedrock and has been referred to as an outwash/till by John R. Rand. The soil grains within the deposit are lightly cemented but the structure remains very pervious. Just above the deposit is a layer up to 6 in.	Mottled light brown to dark gray slightly gravelly silty sand. Based on the grain size curve, this material may be a till. Maximum particle size about 30 mm; particles are subangular to subrounded; gravel sizes are chiefly phyllite, some of which is oxidized and can be broken under slight finger pressure;



Table C-7 (Continued)

<u>Sample Location</u>	<u>Location</u>	<u>Description</u>
B-F110-V (Continued)	thick that is well cemented with hematite or limonite. The three samples were aligned vertically with Sample 1 on top and Sample 3 at the bottom.	contains nonplastic fines; slow reaction to shaking test; some local pockets of light gray sandy silt and occasional oxidation bands. A verticle section showed no apparent bedding (SM). The upper two samples have similar density. The lowest sample is coarser and denser than the other two.
B-F115-VI (Units 4 and 5)	The sample was taken in the very silty or clayey gray till material. The absence of many coarse particles resulted in lower density and a softer consistency than was found in the other tills in Trench B. The sample location is in the southerly portion of Trench B.	Gray brown slightly plastic sandy clayey silt. Slow reaction to shaking test; fines have low plasticity; contains one layer about 15 mm thick of gray sandy clay with low plasticity, and occasional similar pockets from 2 to 5 mm in size; contains a few fine to coarse gravel particles up to about 20 mm size; particles are subrounded to subangular; occasional particles of phyllite; top of sample is somewhat mottled with an oxidation band about 35 mm thick; no apparent bedding noted (CL).

Table C-7 (Continued)

<u>Sample Location</u>	<u>Location</u>	<u>Description</u>
B-F114-VII (Unit 8)	Samples were taken in a material that appeared to be a till or an outwash in the southerly portion of Trench B. During sampling, water was coming out of soil seams that appeared to be horizontal.	Dark gray gravelly silty sand. Widely graded; about 20% fine to coarse gravel up to about 20 mm in size and one coarse gravel particle about 40 mm in size; particles are subangular to subrounded; slow reaction to shaking test; the few fines are slightly plastic; sand and gravel is mainly quartz with some phyllite (SM).
B-CUT-VIII	The sample was taken from a vertically oriented weathered zone in the vertical cut into bedrock at the north end of Trench B. The sample was 2 feet above the base of the cut on the southwesterly face of the rock cut.	Gray-black extremely weathered phyllite. Occasional pyrite; contains weathered quartz pockets or veins; phyllite is weathered in areas to clay of low to medium plasticity. The material is a clayey silt or silty clay that has a smooth graphitic feel and shines easily when rubbed between the fingers. A drained rotation shear test on this sample yielded a steady state (i.e., residual) friction angle of 12°.
B-F115-IX (Unit 2)	See Table C-10 (Samples TRB-1 to TRB-7).	See Table C-10.

Table C-8

Description of Thin Sections and Grain Mounts  
of Samples from Trench A

<u>Sample No.</u>	<u>Thin Section</u>	<u>Brief Description</u>
<u>Thin Section of Till</u>		
Bag Sample 1 Test CM-1*	T-1G	Gray till, far west wall, sharp contact with olive till. Between No. 4 and No. 30 mesh.
Bag Sample 2 Test CM-2	T-1B	Olive till, far west wall, sharp contact with gray till. Between No. 4 and No. 30 mesh.
Bag Sample 3 Test CM-3	IT-2B	Olive till, far west wall, inter-fingered contact with gray till. Between No. 4 and No. 30 mesh.
Bag Sample 4 Test CM-4	IT-2G	Gray till, far west wall, inter-fingered contact with olive till. Between No. 4 and No. 30 mesh.
<u>Grain Mount of Sedimentary Infilling</u>		
Sample D20 Test CM-8	BZ-1	Sedimentary infilling in phyllite in east wall. Between No. 4 and No. 30 mesh.
<u>Thin Section of "Gouge"</u>		
Sample C19 Test CM-9	G-4C	Soft gray "gouge" from about 0.5 ft. north of Station F-1. Elevation is approximately the same as F-1. > No. 200 mesh.
Sample 8 Test CM-13	G-2C	Soft gray "gouge" from the base of east wall of the small trench that contained Station F-3. Elevation is approximately the same as F-3. > No. 4 mesh.
Sample 8 Test CM-13	G-1F	Soft gray "gouge" from the base of east wall of the small trench that contained Station F-3. Elevation is approximately the same as F-3. Between No. 4 and No. 30 mesh.

\*Combined mechanical analysis

Table C-8 (Continued)

<u>Sample No.</u>	<u>Thin Section</u>	<u>Brief Description</u>
Sample 40 Test CM-10	G-3F	Soft gray "gouge" from near F-3. > No. 200 mesh.
Sample 4	APH-1	Soft gray "gouge" from the southern portion of the "gouge" zone, a few inches north of Station F-1. Elevation is approximately the same as F-1. Thin section is approximately perpendicular to foliation, in the plane of the horizontal and oriented.
Sample 4	APH-2	Soft gray "gouge". Thin section is from immediately adjacent to APH-1, approximately perpendicular to foliation, in the plane of the horizontal and oriented.
Sample 4	APV-1	Soft gray "gouge". Thin section is from immediately adjacent to APH-1 and APH-2, approximately parallel to foliation, in the plane of the vertical and oriented.
<u>Thin Sections of Phyllite</u>		
Sample 5 (P-1)	S-10E	Phyllite from approximately 1.5 ft. south of Station F-1 and about 1.5 ft. south of the southern edge of the zone of soft gray "gouge". Thin section is approximately perpendicular to foliation and oriented.
Sample P-2	P-2	Phyllite from exposure located about 25 ft. northwest of Station F-1 in the vicinity of survey station (nail) No. 5. Elevations are approximately the same as survey station No. 5. Thin section is approximately parallel to foliation.



Table C-8 (Continued)

<u>Sample No.</u>	<u>Thin Section</u>	<u>Brief Description</u>
Sample P-3	P-3	Phyllite from immediately adjacent to P-2. Thin Section is approximately perpendicular to foliation.

Table C-8 (Continued)

Descriptions of Grain Mounts of Till

Bag Sample 1 - Grain Mount T-1G. Gray till from far west wall in Trench

A adjacent to sharp approximately horizontal contact between gray and olive tills. Grain Mount T-1G, described below, was prepared from the fraction between No. 4 and No. 30 mesh (4.76 to 0.590 mm) of the soil used for grain size analysis, Test CM-1.

Grain Mount T-1G contains rock fragments and mineral grains including:

8-12% Phyllite, generally dark gray opaque and strongly foliated with some quartzose layers which are iron-stained a rust color. These fragments are very fine-grained and angular to subrounded. One fragment contains a vein of muscovite.

35-40% Quartzite (?), both very fine metasiltstone (?) and fine-grained quartz-rich rock with some feldspar, biotite and muscovite and opaque minerals and sphene (?). Includes some pelitic (?) rocks.

10-15% Schist (?), both muscovite and biotite schists, highly quartzose. Subangular to rounded.

4-5% Granite, comprised of quartz, orthoclase and plagioclase.

20-25% Quartz, angular to subangular grains.

10-15% Plagioclase with albite twinning, weak to strong zoning. Alteration to sericite and clay minerals (?) is common.

4-5% Orthoclase (Microcline) with twinning and ex-solution lamellae. Some alteration to sericite is present.

Weathering of the feldspar grains is probably deuteric (i.e., related to the time of rock origin) rather than a result of weathering of the till, except for the iron-staining of phyllite, which may be the result of weathering of the till combined with circulation of iron-rich and/or oxygen-rich groundwater.

Bag Sample 2 - Grain Mount T-1B. Olive till from far west wall in Trench A

adjacent to sharp, approximately horizontal, contact between gray and olive tills. Grain Mount T-1B, described below, was prepared from the fraction between No. 4 and No. 30 mesh (4.76 to 0.590 mm) of the soil used for grain size analysis, Test CM-2.

Table C-8 (Continued)

Grain Mount T-1B contains rock fragments and mineral grains including:

- 4-5% Phyllite, similar to that in Bag Sample 1.
- 30-35% Quartzite, similar to that in Bag Sample 1, but including one grain which appears to have been intensely sheared.
- 30-35% Schist, similar to that in Bag Sample 1, but includes some very fine-grained fragments.
- 2-3% Granite, similar to that in Bag Sample 1.
- 20-25% Quartz, similar to that in Bag Sample 1.
- 1-2% Plagioclase, similar to that in Bag Sample 1.
- 4-5% Orthoclase, similar to that in Bag Sample 1.

These grains show some minor weathering, but are generally fresh except for some iron-staining associated with phyllite and some of the fine-grained schistose fragments.

Bag Sample 3 - Grain Mount IT-2B. Olive till from far west wall in Trench A in zone where gray and olive till are interfingered. Grain Mount IT-2B, described below, was prepared from the fraction between No. 4 and No. 30 mesh (4.76 to 0.590 mm) of the soil used for grain size analysis, Test CM-3.

Grain Mount IT-2B contains rock fragments and mineral grains including:

- 1-2% Phyllite, similar to that in Bag Sample 1.
- 40-45% Quartzite, similar to that in Bag Sample 1, but including some fragments with a good deal of very fine-grained matrix material.
- 25-30% Schist, similar to that in Bag Sample 2.
- 1-2% Granite, similar to that in Bag Sample 1.
- 5-10% Quartz, similar to that in Bag Sample 1.
- 4-5% Plagioclase, similar to that in Bag Sample 1.
- 8-10% Orthoclase, similar to that in Bag Sample 1.

Weathering is minor in this sample, but iron-staining on schist is common.

The observations on the four grain mounts for Bag Samples 1, 2, 3 and 4 confirm initial impressions from binocular examination of a number

Table C-8 (Continued)

of coarse fractions of these samples, namely that the composition of the gray and olive tills are quite similar, except that the percentage of phyllite is generally higher in the gray till.

Bag Sample 4 - Grain Mount IT-2G. Gray till from far west wall in Trench A in zone where gray till is interfingered with olive till. Grain Mount IT-2G, described below, was prepared from the fraction between No. 4 and No. 30 mesh (4.76 to 0.590 mm) of the soil used for grain size analysis, Test CM-4.

Grain Mount IT-2G contains rock fragments and mineral grains including:

- 5-10% Phyllite, similar to that in Bag Sample 1.
- 20-25% Quartzite, similar to that in Bag Sample 1.
- 25-30% Schist, similar to that in Bag Sample 1, but includes some very fine-grained fragments.
- 20-25% Quartz, similar to that in Bag Sample 1.
- 5-10% Plagioclase, similar to that in Bag Sample 1.
- 10-15% Orthoclase, similar to that in Bag Sample 1, but with some alteration to zeolite (?) and sericite.

Weathering in the rock fragments is minor, except for iron-staining of phyllite. Alteration of the feldspars is also minor and the product is sericite, which is usually a result of deuteritic processes.

Description of Grain Mount of Sedimentary Infilling

Sample D20 - Grain Mount BZ-1. Sedimentary infilling in phyllite bedrock in east wall of Trench A. Graded bedding displayed in-situ. Grain Mount BZ-1, described below, was prepared from fraction between No. 4 and No. 30 mesh (4.76 to 0.59 mm) of sample used for grain size curve, Test CM-8.

Grain Mount BZ-1 contains rock fragments and mineral grains including:

- 60-65% Phyllite, dark gray subangular, opaque and strongly foliated with quartzose and feldspathic (some altered to zeolite) layers.
- 15-20% Quartzite, angular to subrounded, fine and very fine-grained metasiltstone (?), includes some quartz-rich grains with phyllitic concentrations.



Table C-8 (Continued)

5-10% Quartz, angular to subangular grains.

2-3% Plagioclase, subangular to subrounded, with albite twinning and some weak to strong zoning.

1-2% Orthoclase (microcline), subangular to subrounded showing exsolution.

<1% Zeolite grain, subangular, probably altered from feldspar.

All weathering is very minor, except for deuteric alteration of feldspar. No iron-staining is present.

Descriptions of Thin Sections of "Gouge"

Sample C19 - Grain Mount G-4C. Soft gray "gouge" collected from below Point F1, Trench A for grain size determination, Test CM-9. Grain Mount G-4C was prepared from the plus No. 200 mesh fraction of the grain size sample.

Grain Mount G-4C contains:

65-70% Phyllite, dark gray, generally opaque, strongly foliated, subangular to angular fragments. Some grains contain layers abundant in zeolite and a few concentrations of quartz or pyrite grains. In some cases crystallization of zeolite appears to have broken apart phyllite fragments, possibly due to volume expansion upon alteration from feldspar.

10-15% Quartzite, very fine to fine-grained metasiltstone, angular to subrounded. Some grains or areas of grains appear to have been sheared. Sometimes grades to phyllite, or is locally micaceous (muscovite).

1-2% Orthoclase (Microcline), angular grains, shows exsolution.

10-15% Zeolite, clear, subangular to subrounded grains, some with quartz and some attached to phyllite grains.

Sample 8 - Grain Mount G-2C. Soft gray "gouge" collected from near Point F3, Trench A, for grain size determination Test CM-13. Grain Mount G-2C was prepared from the plus No. 4 mesh fraction of the grain size sample.

Table C-8 (Continued)

Grain Mount G-2C contains five quartzite grains 1 to 4 mm across. Most are comprised mainly of quartz with some feldspar. The quartz is very angular and texture changes abruptly from very fine to fine in some places. There is also one grain of phyllite veined with zeolite.

Sample 8 - Grain Mount G-1F. Soft gray "gouge" collected near Point F3, east wall, Trench A, for grain size determination, Test CM-13. Grain Mount G-1F was prepared from fraction between No. 4 and No. 30 mesh (4.76 to 0.59 mm) of sample used for grain size.

Grain Mount G-1F contains rock fragments and mineral grains including:  
5-6% Phyllite, similar to that in Sample No. C19.  
60-70% Quartzite, similar to that in Sample No. 8, showing possible evidence of shear.

Sample 40 - Grain Mount G-3F. Soft gray "gouge" collected near Point F3, Trench A. Grain Mount G-3F, was prepared from the plus No. 200 mesh fraction of the sample used for grain size Test CM-10. This mount appears similar to G-1F, but is too fine-grained for analysis.

Descriptions of Thin Sections of Phyllite

Sample 5 (P-1) - Thin Section S-10E. Phyllite. Oriented sample collected adjacent to south side of "gouge" zone on floor of Trench A as exposed on May 28, 1975. Thin Section S-10E, described below, was cut vertically and perpendicular to the strike of the foliation. The phyllite is dark gray to black, generally opaque and very fine-grained. Some euhedral pyrite grains are evident as well as some quartz grains with angular shapes, suggesting that they may have been subject to regional metamorphic processes. A pyrite vein was "plucked" from this thin section during fabrication.

Sample P-2 - Thin Section P2. Phyllite. Unoriented sample from north side of "gouge" zone in Trench A as exposed on May 28, 1975. Thin Section P2, described below, was cut parallel to foliation. Generally similar to thin section for Sample 5 (P-1).

Table C-8 (Continued)

Sample P-3 - Thin Section P3. Phyllite. Unoriented sample collected from north side of "gouge" zone on floor of Trench A as exposed on May 28, 1975. Thin section P3, described below, was cut perpendicular to foliation.

Sample contains a great deal of very fine-grained quartz and muscovite and probably represents gradation between phyllite and metasiltstone. This section includes structural evidence of shear, i.e., disruption and rotation of fabric that is typical of metamorphosed rocks of this type.

Sample 4 - APH-1. See Photos A-34, 35, 36, 39 and 40.

APH-2 and APV-1 were not described individually but are in the general discussion of "gouge" in Section V.2 of the report.

Table C-9  
Rotation and Direct Shear Tests on Till and "Gouge" from Trench A

<u>Sample</u>	<u>Type of Test</u>	<u>Effective Normal Stress, <math>\sigma_v</math></u>	<u>Total Displacement</u>	<u>Comments</u>
Block #2, original east wall (Till)	Direct Shear	332 psi (23.4 kg/cm <sup>2</sup> )	0.33 in. (0.83 cm)	<ol style="list-style-type: none"> <li>1. Test performed in fully drained condition on sample one inch thick.</li> <li>2. A distinct failure plane did not develop; abrupt discontinuity only occurred at edges.</li> <li>3. No evidence of fabric, striations, or grain orientation in failure zone that looked different from unsheared till - See Photo A-31.</li> </ol>
#22 (Till)	Rotation Shear	47 psi (3.3 kg/cm <sup>2</sup> )	360° or 12.2 in. (31.0 cm)	<ol style="list-style-type: none"> <li>1. Test performed on disturbed sample 3/16 in. (0.15 cm) thick with grain size less than 1 mm.</li> </ol>
"	"	94 psi (6.6 kg/cm <sup>2</sup> )	"	<ol style="list-style-type: none"> <li>2. Effective normal stress was increased in increments as stated.</li> </ol>
"	"	189 psi (13.3 kg/cm <sup>2</sup> )	"	<ol style="list-style-type: none"> <li>3. Failure surface was dull and rough.</li> </ol>
"	"	283 psi (19.9 kg/cm <sup>2</sup> )	"	<ol style="list-style-type: none"> <li>4. A few small areas developed striations and the few grains of phyllite were polished.</li> <li>5. Conclude that observable fabric as a result of shear would only be observed in-situ in this till after large, concentrated displacements have occurred under substantially high pressure.</li> </ol>



Table C-9 (Continued)

<u>Sample</u>	<u>Type of Test</u>	<u>Effective Normal Stress</u> $\bar{\sigma}_v$	<u>Total Displacement</u>	<u>Comments</u>
#26 ("Gouge")	Rotation Shear	47 psi (3.3 kg/cm <sup>2</sup> )	360° or 12.2 in. (31.0 cm)	1. Test performed on disturbed sample 0.27 in. (0.19 cm) thick with grain size less than 1/8 inch.
"	"	94 psi (6.6 kg/cm <sup>2</sup> )	"	2. Effective normal stress was increased in increments as stated.
"	"	189 psi (13.3 kg/cm <sup>2</sup> )	"	3. At the completion of the test (after rotation at $\bar{\sigma}_v = 283$ psi), the fabric along the failure plane was clearly glossy and striated as shown in Photo A-29.
"	"	283 psi	"	4. There was no strong evidence of the direction of rotation (similar attempts to determine direction of shear from observations of a slickensided surface of clay e.g., LaGatta (1970), have also been unsuccessful).
#25 ("Gouge")	Rotation Shear	43 psi (3 kg/cm <sup>2</sup> )	0.06 in. (0.15 cm)	Shear stress = 18 psi, 1. Sample prepared No evidence of slickensides similar to Sample #26.
"	"	28 psi (2 kg/cm <sup>2</sup> )	0.41 in. (1.04 cm)	Shear stress = 22 psi, 2. Atterberg Limits No evidence of slickensides starting from air dry state were: LL=18, PL=12, PI=6.
"	"	57 psi (4 kg/cm <sup>2</sup> )	0.39 in. (0.99 cm)	Shear stress = 43 psi, No evidence of slickensides

Table C-9 (Continued)

<u>Sample</u>	<u>Type of Test</u>	<u>Effective Normal Stress</u> $\bar{\sigma}_v$	<u>Total Displacement</u>	<u>Comments</u>
#25 (Con't) ("Gouge")	Rotation Shear	114 psi (8 kg/cm <sup>2</sup> )	0.39 in. (0.99 cm)	4. Shear stress = 43 psi, No evidence of slickensides
		114 psi (8 kg/cm <sup>2</sup> )	3.94 in. (10.01 cm)	
		213 psi (15 kg/cm <sup>2</sup> )	3.94 in. (10.01 cm)	4. Shear stress = 76.5 psi, Oriented fabric observed, partings beginning to develop within 0.02 inches from bottom surface, no evidence of slickensides.
		270 psi (19 kg/cm <sup>2</sup> )	3.94 in. (10.01 cm)	
#25 ("Gouge")	Direct Shear	142 psi (10 kg/cm <sup>2</sup> )	0.19 in. (0.48 cm)	5. Shear stress = 115 psi, orientation and foliation more evident.
				1. Specimen size: 2.2 in. diameter. 2. Displacement Rate: 0.26 x 10 <sup>-4</sup> in/min. 3. Fully drained. 4. Friction angle at peak was 37° and at final displacement was 35°. 5. No difference observed between shear zone and unsheared "gouge" at these small displacements.

Table C-9 (Continued)

Note: A plot of the results of the rotation shear tests on Sample #25 on the Mohr diagram is a straight line with an inclination of  $21.5^\circ$ . The friction angle measured on Sample B-CUT-VIII, chiefly fine-grained chlorite, was  $12^\circ$ . A pure quartz or feldspar sand (which are bulky-grained as compared to chlorite or graphite) would show a friction angle of  $28^\circ$  to  $32^\circ$  if tested under the same conditions.

Table C-10

Description and Location of Tests on Beach Sands on North End of Sears Island and of Outwash in Trench B

<u>Sample No.</u>	<u>Location</u>	<u>Depth (in.)</u>	<u>Est. El MSL (ft.)</u>	<u>Description</u>
NWB 1	30 feet east of mean tide line. Dec. 9, 1975 Northwest beach	2-4	+3	Gravelly sand, clean. Siltstone and metasiltstone fragments somewhat flat or elongate, some have rounded edges. Quartz and feldspar fragments are bulky and subangular. Phyllite is absent. Shells are prevalent in fragments $\frac{1}{2}$ in. size and smaller. One frosted glass shard.
NWB 2	About at mean tide line. Dec. 9, 1975 Northwest beach	0-3	0	Gravelly sand, clean. Siltstone and metasiltstone particles are not quite as flat as for NWB 1. Their edges are less angular - more worn than for NWB 1. Quartz and feldspar are bulky and subangular. Phyllite is absent. Shells far less numerous, and largest ones are $\frac{1}{8}$ in. size.
NWB 3	Northwest beach About 5 ft. west of driftwood. Dec. 9, 1975	0-3	+6	Gravelly sand, clean. Siltstone and metasiltstone fragments are very flat, with minor to major diameter ratios of 1:10 prevalent. Much greater appearance of flat grains than NWB 1. Quartz and feldspar grains are bulky and subangular. One green, unfrosted, glass shard. Shells are less numerous than in NWB 1 and are $\frac{3}{16}$ in. and smaller. Phyllite is absent.



Table C-10 (Continued)

<u>Sample No.</u>	<u>Location</u>	<u>Depth (in.)</u>	<u>Est. El MSL (ft.)</u>	<u>Description</u>
NEB-4	Northeast beach About mean tide level. 200 ft. N of south end of spit. Dec. 9, 1975	0-3	0	Gravelly sand. Clean. About 10-20% phyllite fragments that are very flat (1:10). Siltstone and metasilstone are less flat (1:2 to 1:5). Quartz and feldspars bulky and angular to subangular. Very few shells, up to $\frac{1}{4}$ in. size. Some of the siltstone grains have subrounded to rounded edges. Fines are quartz, phyllite, siltstone.
NEB-5	Northeast beach near mean tide, 500 ft. N of south end of spit. Dec. 9, 1975	0-3	0	Gravelly sand. Clean. About 2 to 5% phyllite, all in grains smaller than $\frac{1}{8}$ in. size and flat. Larger gravels are sandstone or siltstone with ratios as great as 1/15. Quartz and feldspars bulky, angular to subangular. Shells to $\frac{1}{4}$ in. size, $<\frac{1}{2}\%$ . A few granite fragments, bulky and subangular.
NEB-6	Northeast beach Furrow just above high tide. 50 ft. N of NEB-5	0-1	+6	Coarse sandy gravel. Uniform and clean. Chiefly siltstone and metasilstone in flat particles with 1:3 to 1:10 ratios of minor to major diameters. Some bulky subangular particles of granite. A few shells up to $\frac{1}{4}$ in. size. A few quartz and feldspar grains, which are bulky and subangular.

Table C-10 (Continued)

<u>Sample No.</u>	<u>Location</u>	<u>Depth (in.)</u>	<u>Est. El MSL (ft.)</u>	<u>Description</u>
NEB-7	Northeast beach N end of beach	0-4	0	Gravelly sand. Clean. Coarser grains are similar to NEB-6. Sand sizes are chiefly quartz grains that are bulky and angular to subangular. A few shells up to $\frac{1}{4}$ in. size.
TRB-1	Trench B, outwash at south end, east face Dec. 8, 1975	9-11	See Figure 9	Uniform, medium sand. Grains are chiefly quartz, bulky, angular to subangular. 10-20% feldspar, 10-20% rock fragments of siltstone, metasiltstone, and phyllite. Feldspars are bulky and angular to subangular. Phyllite fragments are flat or elongate, siltstone fragments are less flat and occasionally bulky. All grains stained with rusty products of weathering.
TRB-2 (B-F115-IX)	Trench B, outwash at south end, east face Dec. 8, 1975	13.5 to 14.5	"	Uniform gravelly coarse sand. The $\pm 1/8$ in. sizes are chiefly metasiltstones that have 1:3 to 1:6 ratios of minor to major diameters, and bulky, angular feldspar fragments. A few percent phyllite particles, which are flat or elongate, are present. Contains little quartz. All grains stained due to weathering.
TRB-3 (B-F115-IX)	Trench B, outwash(?) at south end, east face Dec. 8, 1975	15.5 to 17	"	Sandy gravel. Till. Maximum size 1.5 in. Grains larger than 1/8 in. size are siltstone, metasiltstone, phyllite, and some feldspar. Feldspars are bulky and

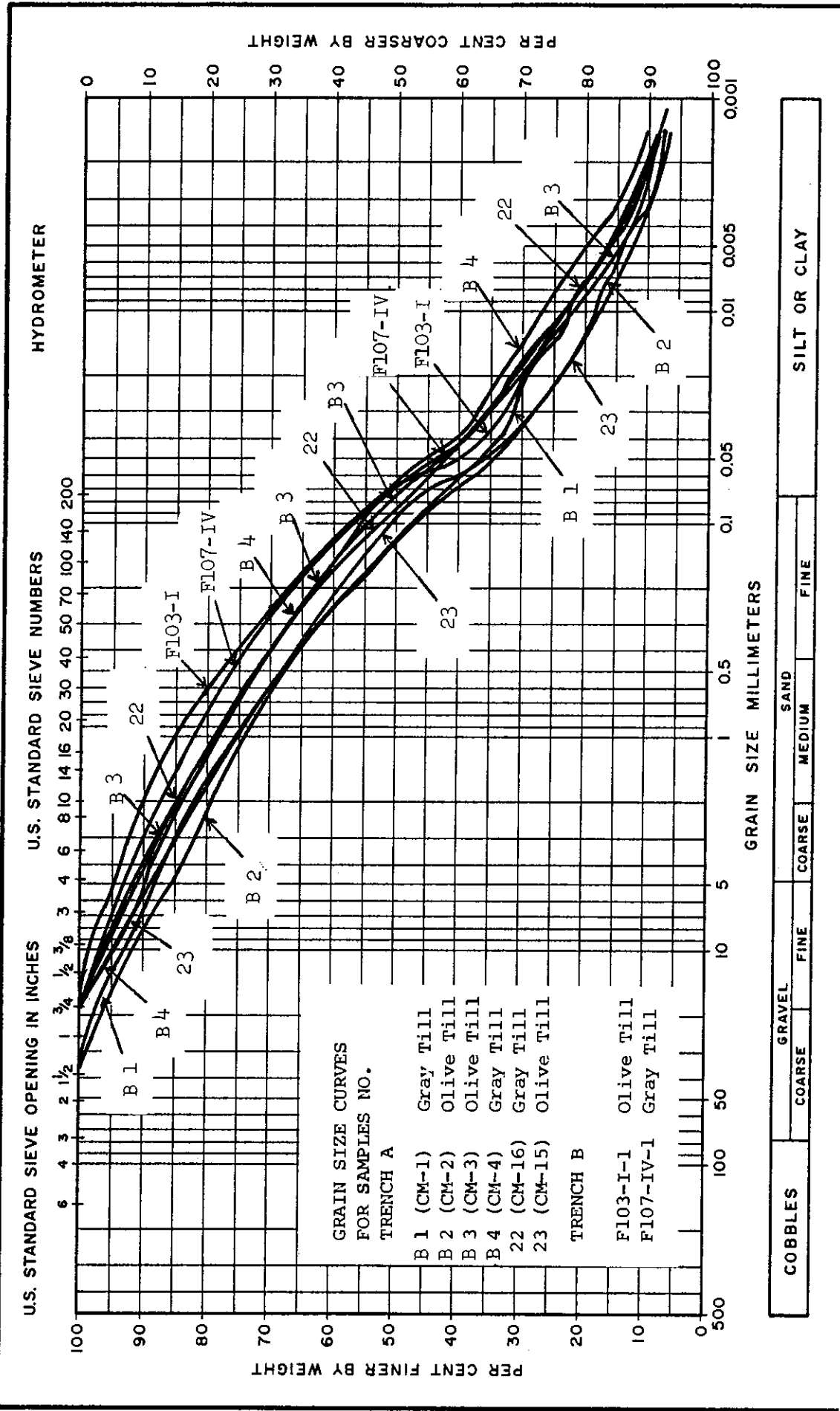
Table C-10 (Continued)

<u>Sample No.</u>	<u>Location</u>	<u>Depth (in.)</u>	<u>Est. El MSL (ft.)</u>	<u>Description</u>
TRB-3 (Con't)			See Figure 9	subangular, others are flattish with 1:3 to 1:6 ratios. Finer grains are chiefly bulky, angular quartz with some feldspar and rock fragments. No shells or fragments of shells. Most grains are stained due to weathering.
TRB-4 (B-F115-IX)	Trench B, outwash south end of east face Dec. 8, 1975	18 to 20	"	Medium sand. Slightly gravelly, slightly silty. More uniform than TRB-3. Predominantly siltstones, meta-siltstones and feldspar. Minor to major diameters range from 1:2 to 1:7 for all but feldspars, which are bulky and subangular. Grains are stained due to weathering. One 1/8 in. shell fragment found. About 5-10% phyllite appearing in grains with ratios of 1:5 to 1:12.
TRB-5 (B-F115-IX)	Trench B, outwash south end of east face Dec. 8, 1975	20 to 20.5	"	Uniform coarse sand. Siltstone and metasiltstone, feldspars, phyllite and quartz in order of descending quantity. Grain shapes similar to TRB-2. No shells. Grains stained due to weathering.
TRB-6 (B-F115-IX)	Trench B, outwash(?) south end of east face Dec. 8, 1975	22.5 to 27.5	"	Sandy gravel. Till. Gravel sizes are siltstone, metasiltstone, granite, phyllite with rusty stains. Shapes generally bulky and subangular although siltstones tend to be flatter and rare phyllites quite flat. Finer grains similar to TRB-3. Grains stained due to weathering. No shells.

Table C-10 (Continued)

<u>Sample No.</u>	<u>Location</u>	<u>Depth (in.)</u>	<u>Est. El MSL (ft.)</u>	<u>Description</u>
TRB-7 (B-F115-IX)	Trench B, outwash south end of east face Dec. 8, 1975	29 to 30	See Figure 9	Sandy gravel. Similar to TRB-2 except contains less phyllite.





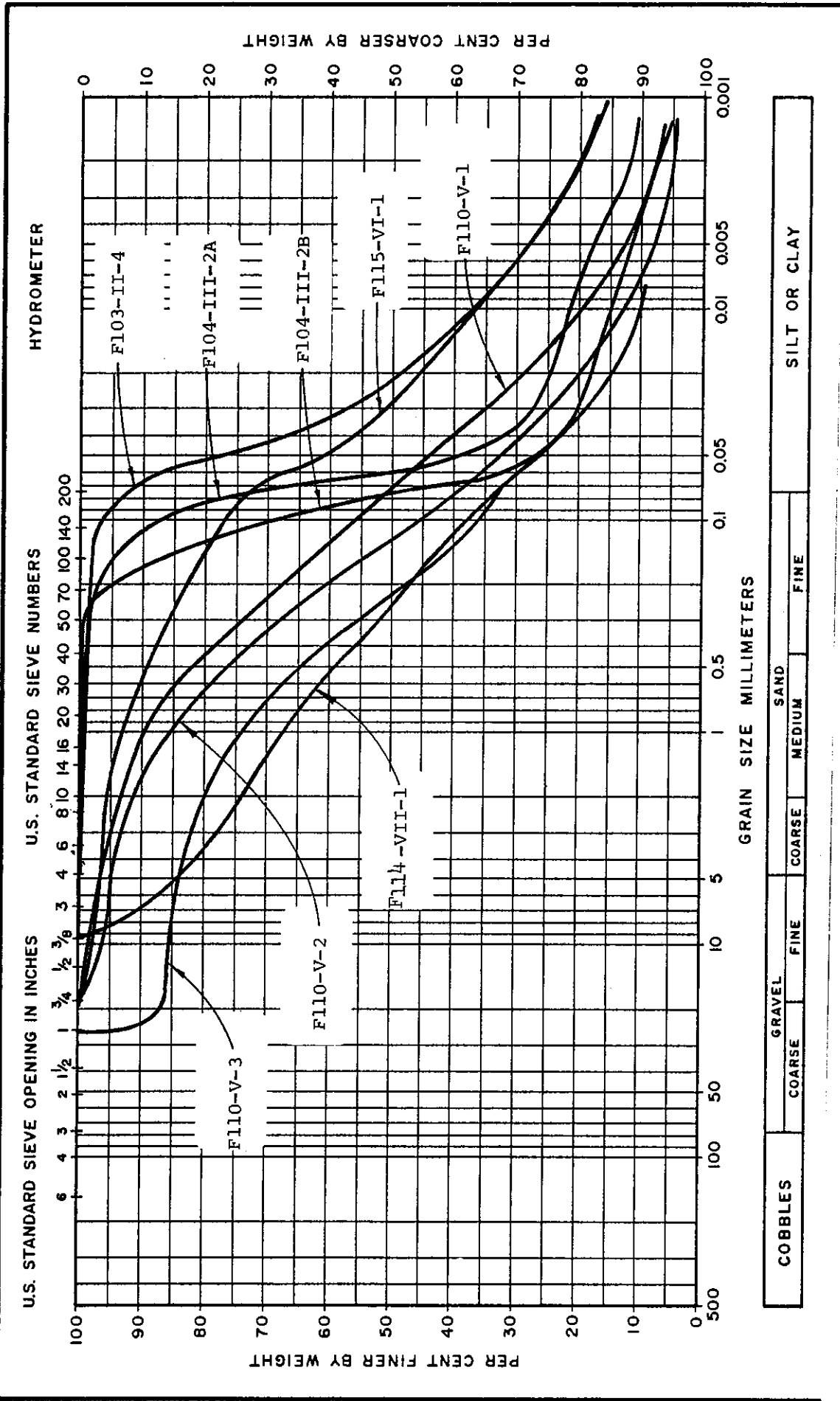
11-3

**Note:** The designation "CM-1" indicates a combined mechanical analysis.

**Source:** Geotechnical Engineers Inc.

**Grain Size Curves:** Laurentide Lodgment Tills, Trenches A and B

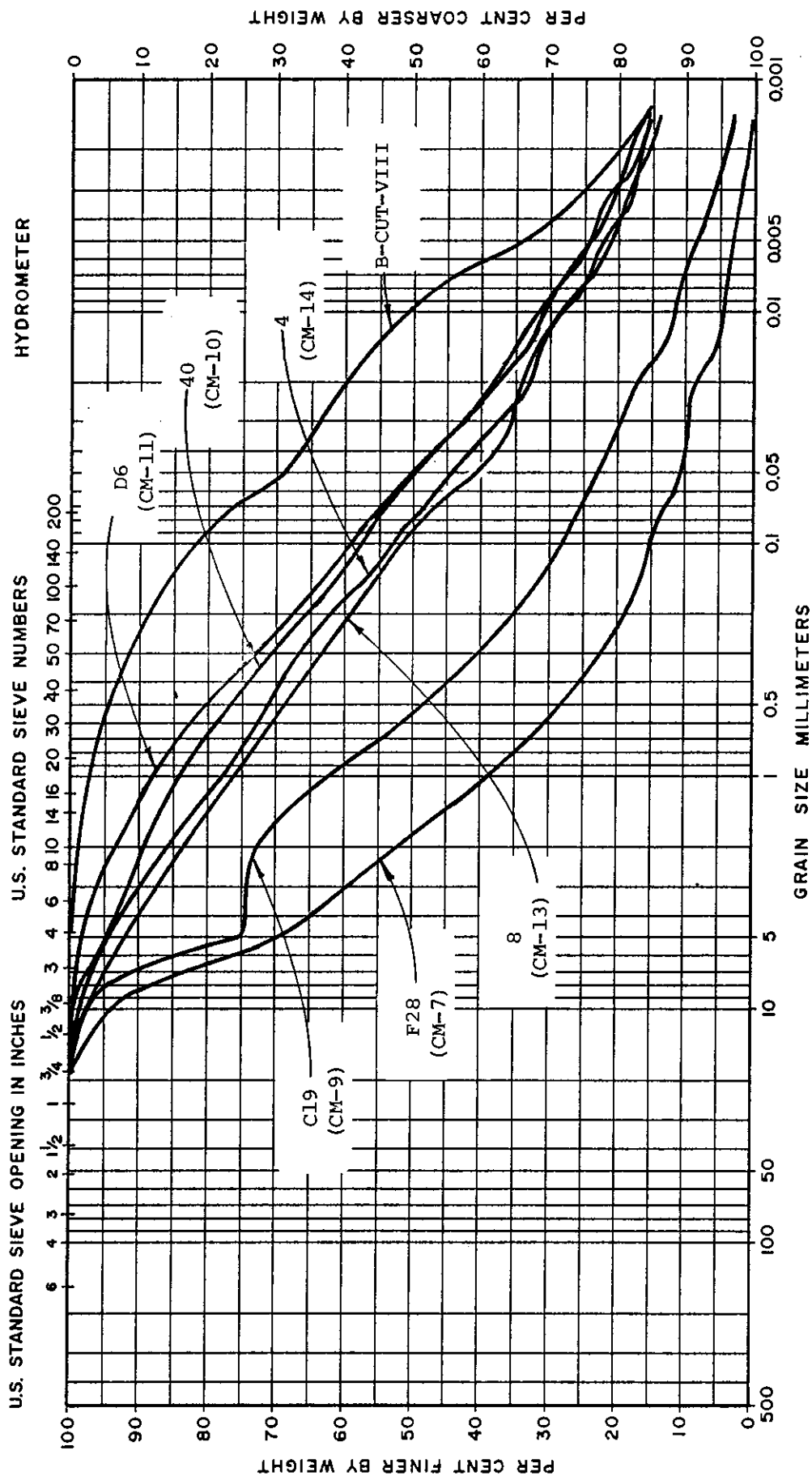
Graph C-11



Note: Marine Deposits are -II, -III, -VI Old Till/Outwash are -V, -VII

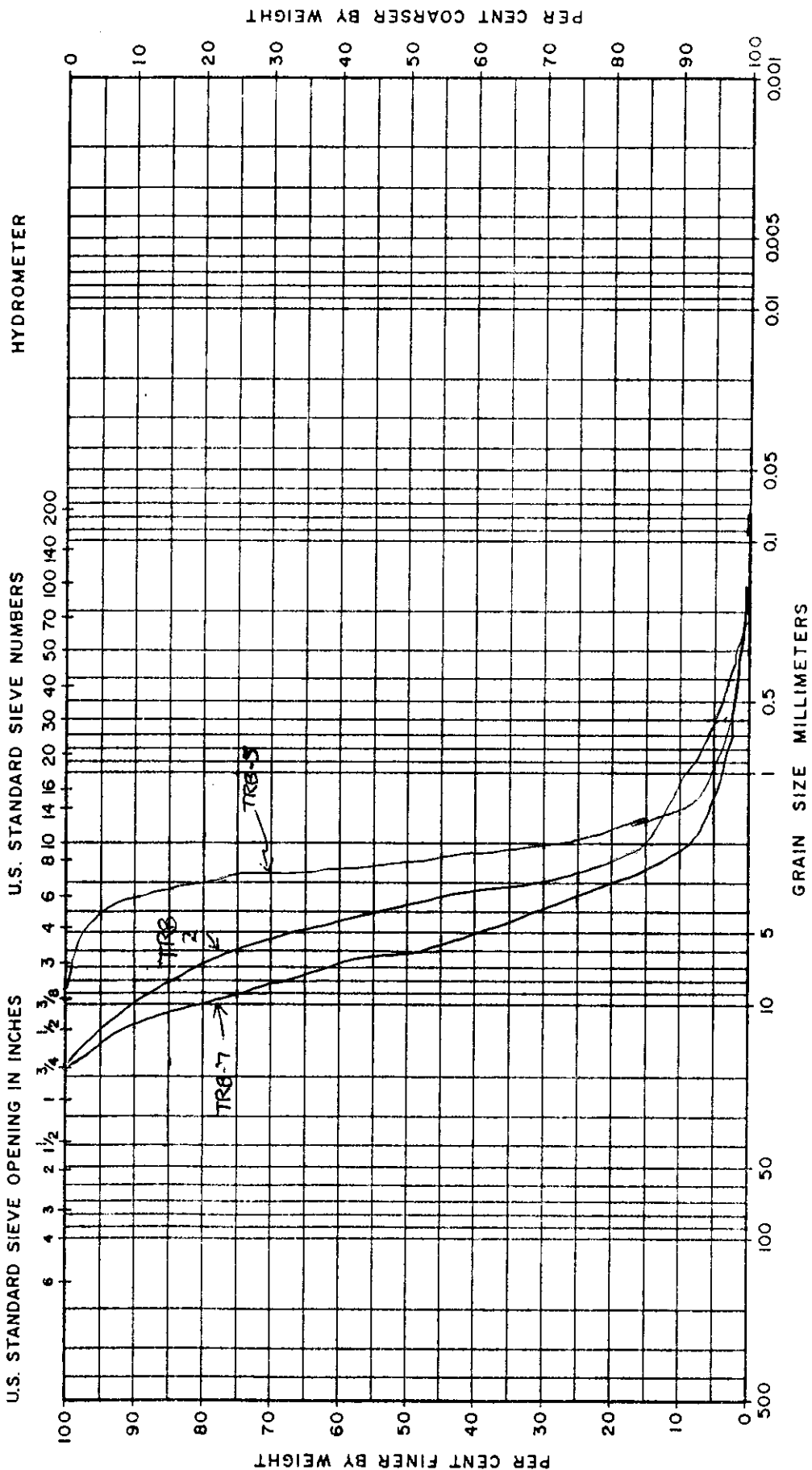
Source: Geotechnical Engineers Inc.

Grain Size Curves: Marine Deposits and Old Tills and Outwash, Trench B Graph C-12



COBBLES	GRAVEL		SAND			SILT OR CLAY	
	COARSE	FINE	COARSE	MEDIUM	FINE		

Source: Geotechnical Engineers Inc.  
 Grain Size Curves: Soft Gray "Gouge" Trenches A and B  
 Graph C-13



**Unified Soil Classification**

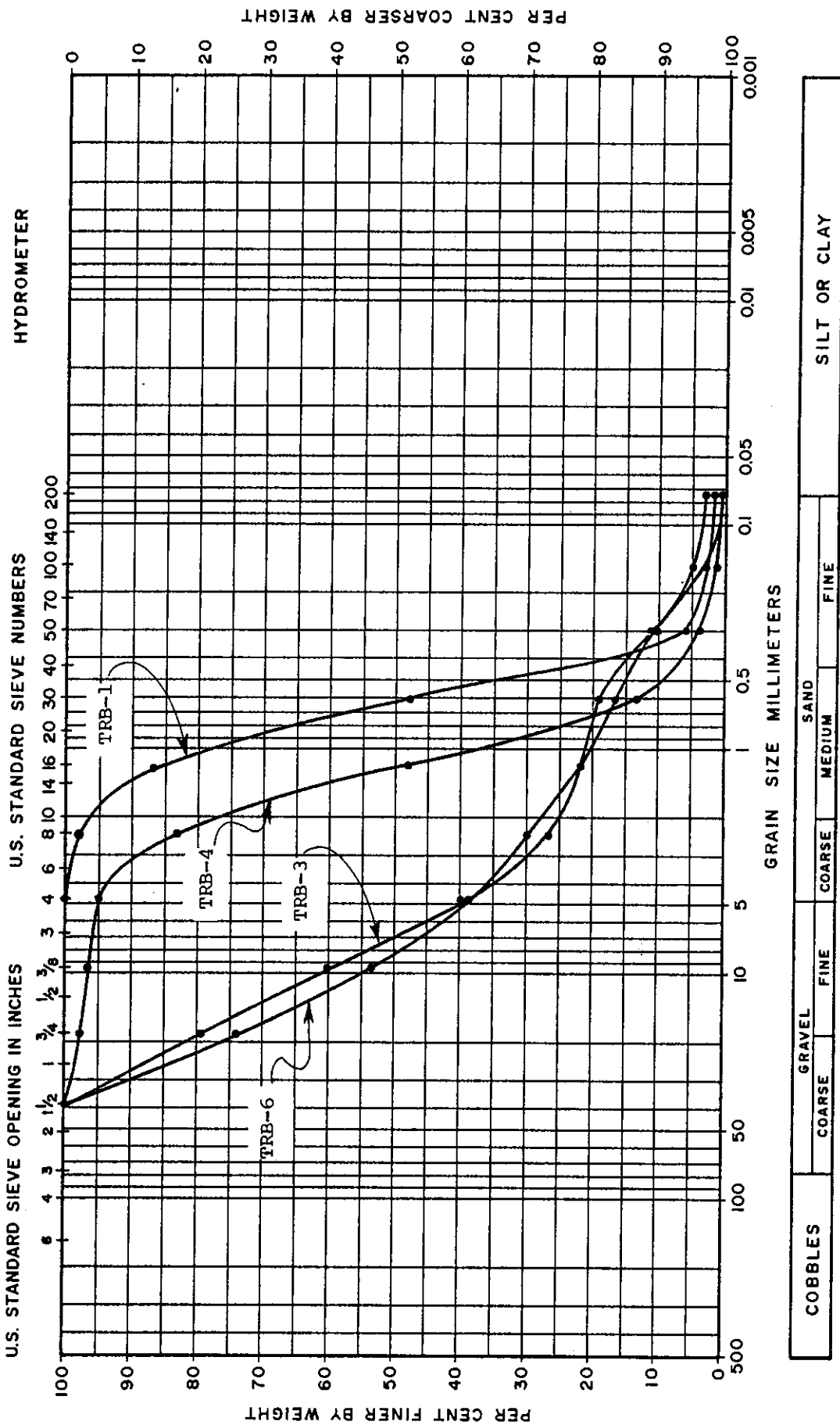
Note: Samples Taken from Location B-F-115-IX on East Wall, south end of Trench B

Source: Geotechnical Engineers Inc.

Grain Size Curves: Coarser Strata in Upper Outwash, Trench B

Graph C-14

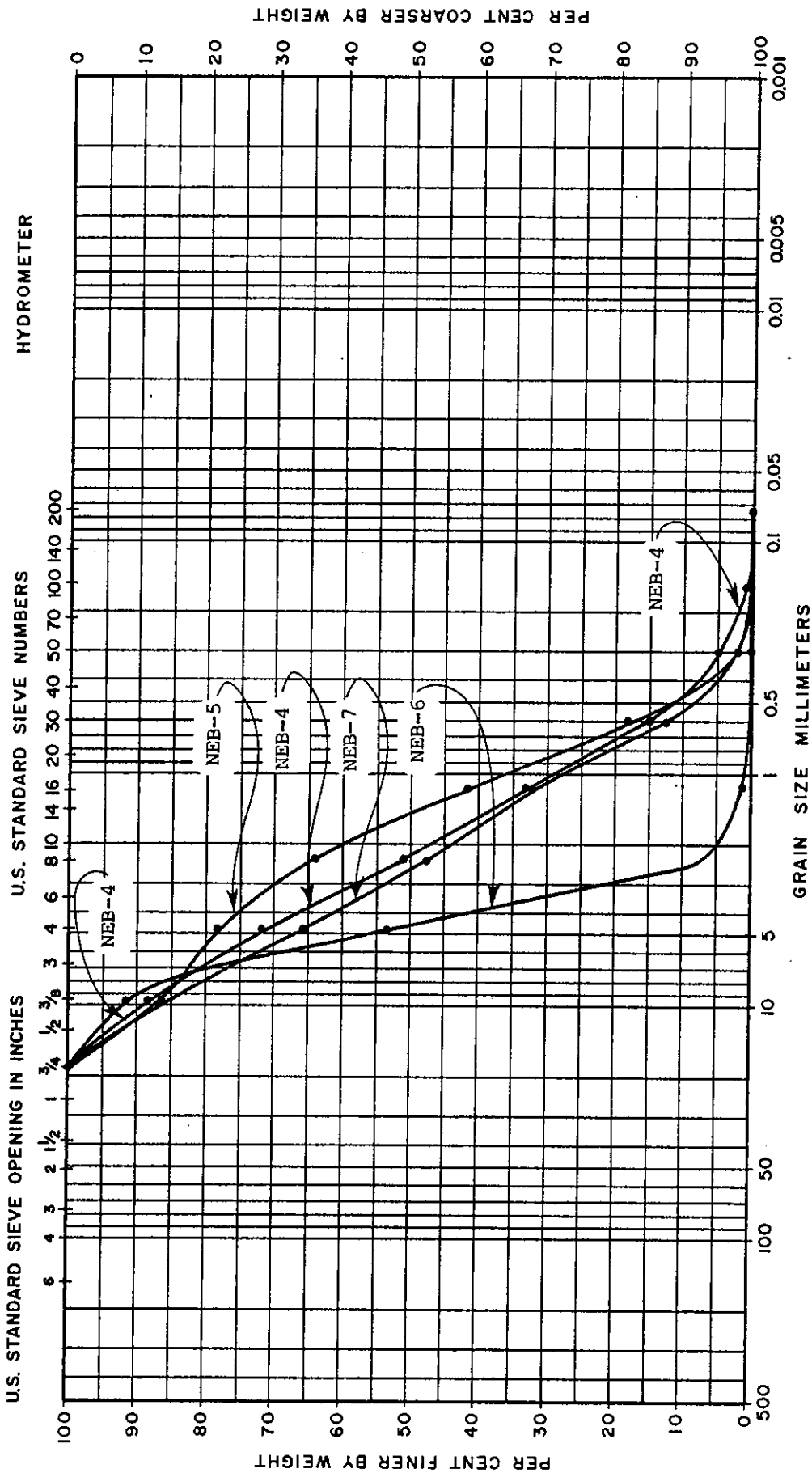




Note: Samples Taken from Location B-F115-IX on the east wall, south end of Trench

Source: Geotechnical Engineers Inc.

Grain Size Curves: Finer and More Widely-Graded Strata in Upper Outwash, Trench B



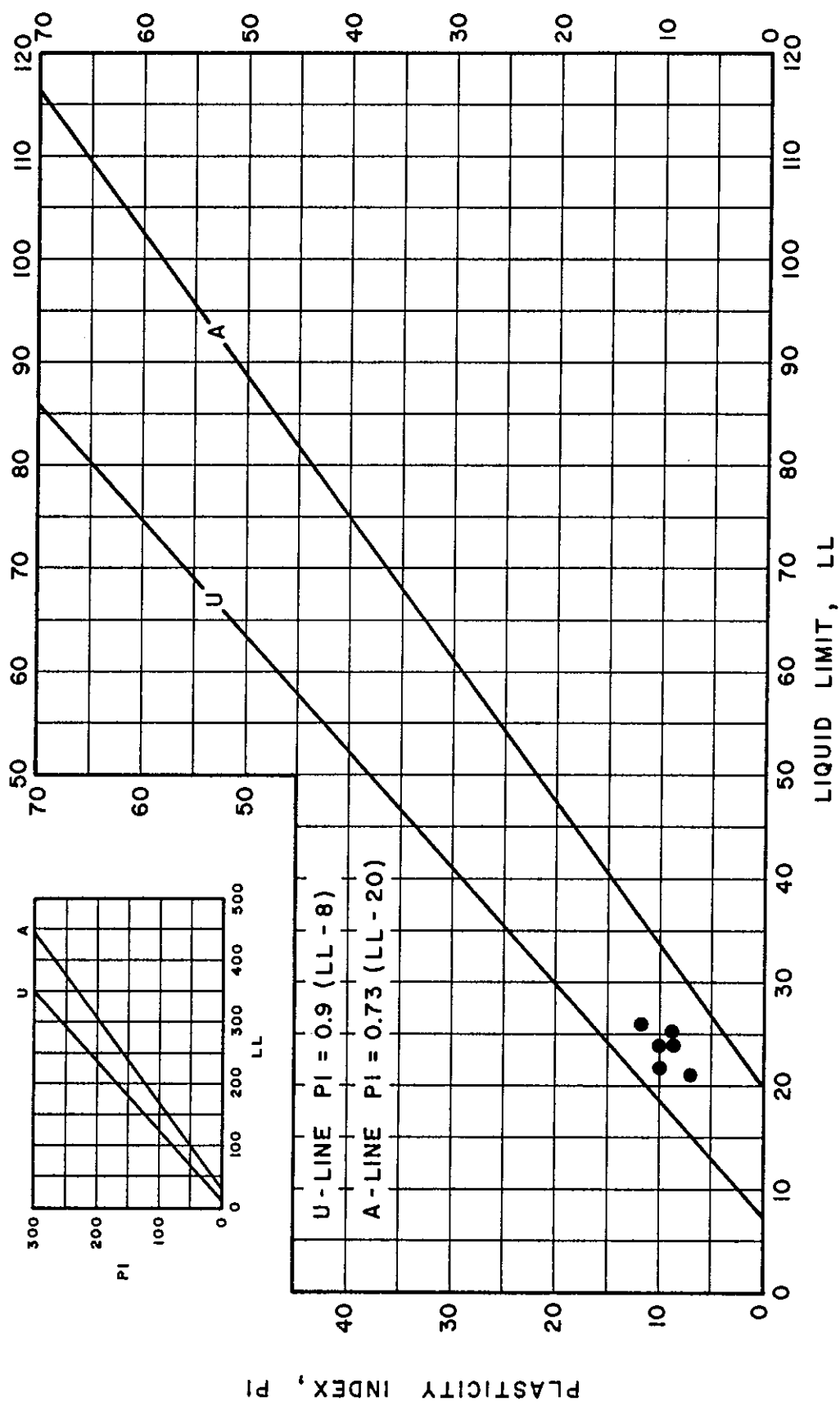
COBBLES		GRAVEL		SAND			SILT OR CLAY		
COARSE	FINE	COARSE	FINE	COARSE	MEDIUM	FINE			

Note: Samples taken from various elevations and locations on existing beach

Source: Geotechnical Engineers Inc.

Grain Size Curves: Beach Deposits on Northeast end of Sears Island





Note: Includes Samples  
 FLO3-I, FLO7-IV,  
 F115-VI, B1, B2,  
 B4

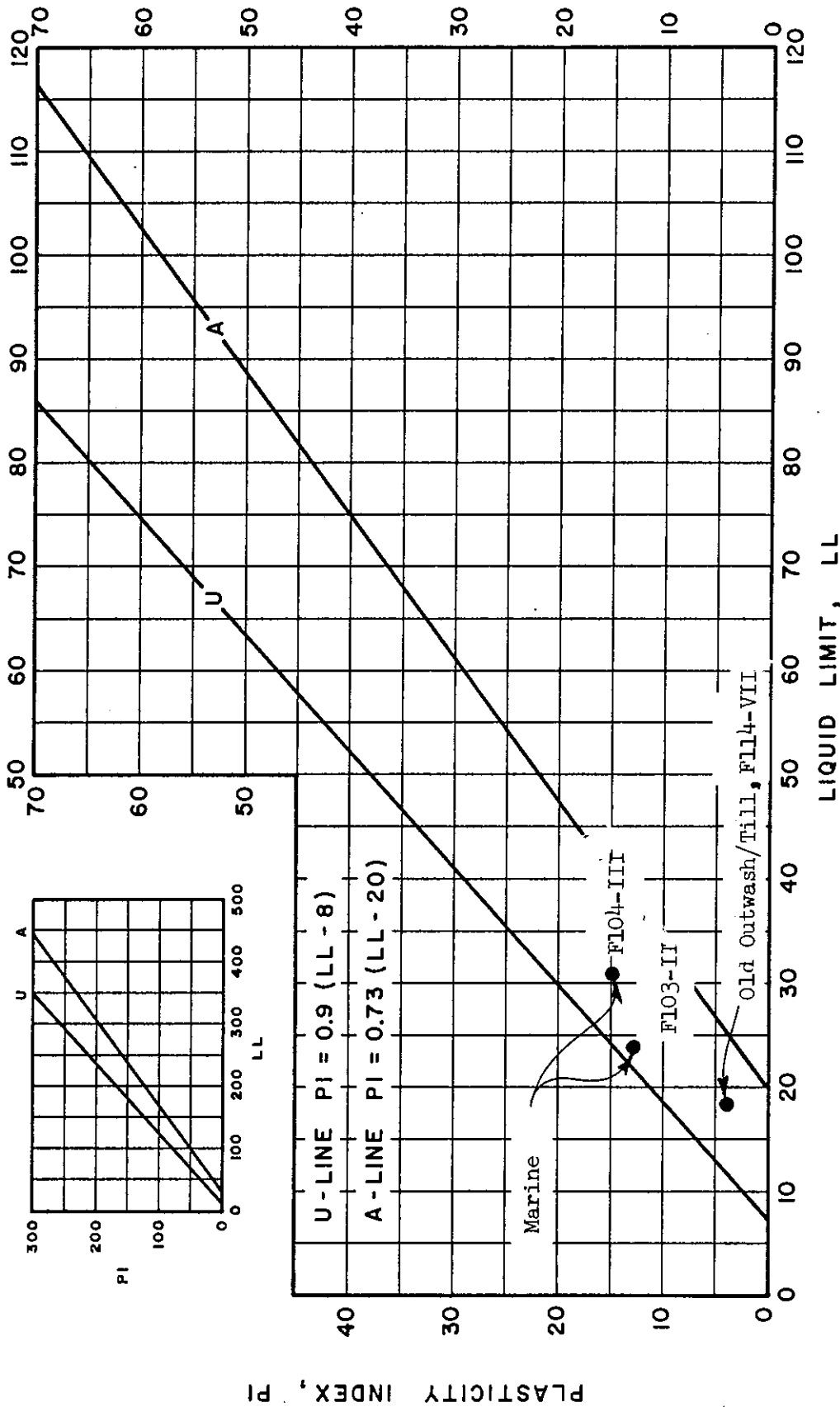
Source:

Geotechnical  
 Engineers Inc.

Plasticity Chart:  
 Laurentide lodgment  
 tills, Trenches A  
 and B

Graph C-18





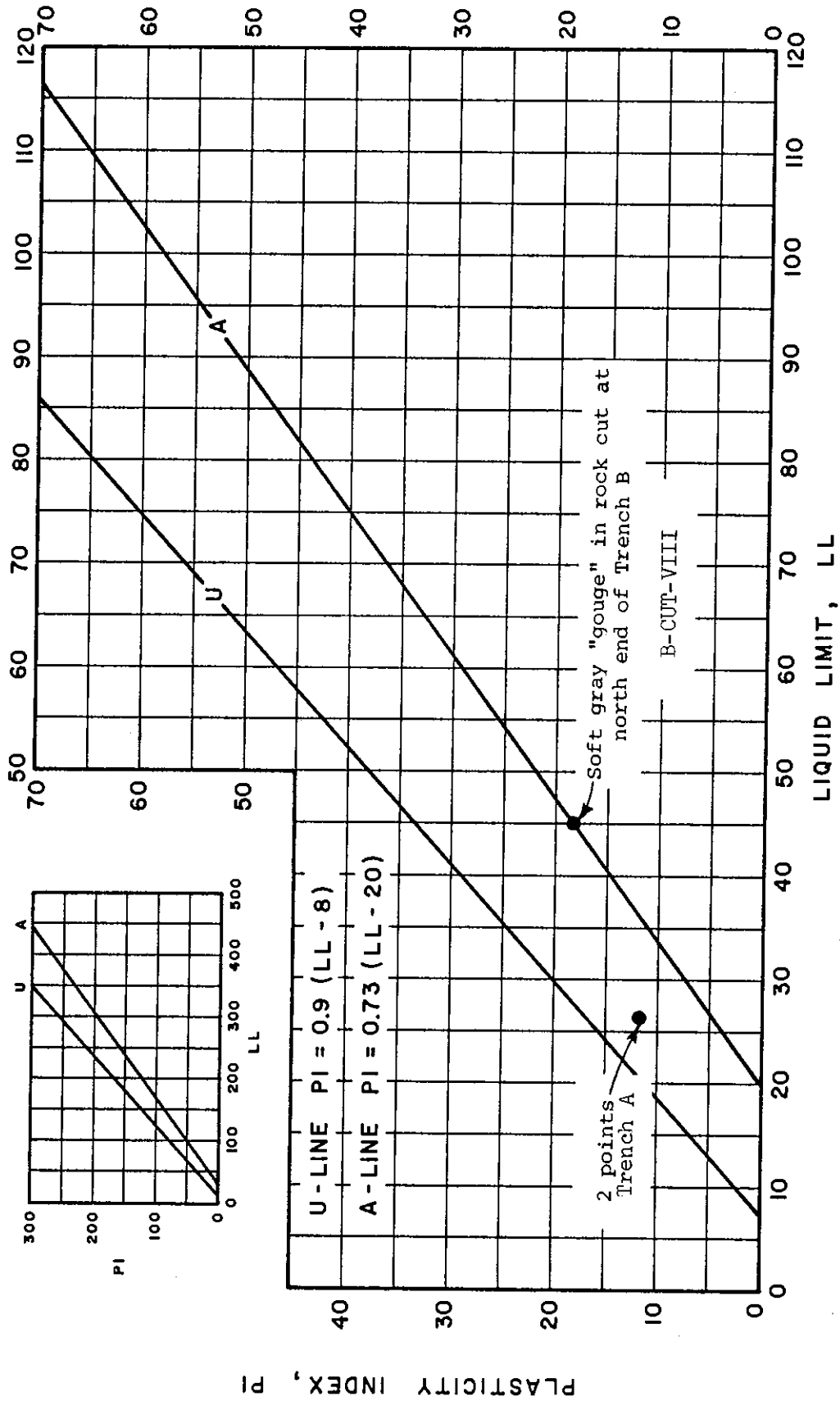
Source:

Geotechnical  
Engineers Inc.

Plasticity Chart:

Marine Deposits and  
old Outwash/Till,  
Trench B

Graph C-19



Source: Geotechnical Engineers Inc.

Plasticity Chart:  
Soft Gray "Gouge",  
Trenches A and B

Graph C-20

APPENDIX D  
"Gouge" Intrusion Models  
Contents

<u>Section</u>	<u>Page</u>
<u>Introduction</u>	D-1
<u>Model 1 - Locked in Horizontal Stress</u>	D-2
<u>Model 2 - Horizontal Stresses Induced by Glacier on North Side of Fault</u>	D-3
<u>Summary and Conclusions</u>	D-5
<u>Calculations</u>	D-6
Model 1 - Locked in Horizontal Stress	D-6
Assumptions	D-6
Model	D-7
Solution	D-8
Model 2 - Glacier North of Fault	D-11
Model Description and Assumptions	D-11
A. Vertical and horizontal stress due to weight of ice	D-13
B. Vertical and horizontal stresses due to shear at base of ice	D-14
C. Horizontal stress due to topographic relief	D-15
Sum horizontal and vertical stresses at fault	D-16
Compare shear stress at "gouge" with its strength	D-17

Appendix D

"Gouge" Intrusion Models

by

Geotechnical Engineers Inc.

Introduction

The following is a summary of the calculations made to quantify the possible effects of glacier stresses on the weathered bedrock fault zone in Trenches A and B. Two distinct models that are consistent with the observed squeezing of the weathered bedrock and "gouge" were developed. The calculations are attached.

In Trench A, the direct observations by J. R. Rand and the seismic velocity measurements by Weston Geophysical show that the weathered bedrock zone is about 50 feet (17 m) wide. Several bedrock faults are found in this weathered zone. The properties of the materials in the fault zone and in the adjacent bedrock were determined by Weston Geophysical to be as follows:

<u>Material</u>	<u>P-Wave Velocity</u> fps (mps)	<u>Modulus of Elasticity</u> 10 <sup>4</sup> psi (10 <sup>4</sup> kg/cm <sup>2</sup> )
Fresh bedrock	13000 to 14000 (4000 to 4300)	400 (28)
Weathered bedrock in fault zone	8000 to 9500 (2400 to 2900)	60 to 100 (4 to 7)
Soft, gray, "gouge"- like, extremely weathered phyllite	~5000 (~1500)	5 to 11 (0.35 to 0.8)

Observations in a bedrock excavation in Trench A show that there is a bedrock fault plane near the north end of the excavation which dips 66° to the southeast, and a fault plane near the south end which dips 80° to the northwest, i.e., in the near-surface exposure there is a bedrock fault zone which contains fault planes that converge slightly with increasing depth. The dip of the fault zone at depth is not known.



### Model 1 - Locked-In Horizontal Stress

For this model it was assumed that the "gouge" could be represented as a one-foot-thick vertical zone of soft material within a 50-ft-wide zone of weathered bedrock. The continental glacier is assumed to have built up to a thickness of 3600 to 5200 ft. (1100 to 1600 m.), to have scraped the rock clean, and laid lodgment till down in what is now the bedrock low of Trenches A and B. As a result, it is assumed that when the glacier was at full height, the till overlaid the bedrock and "gouge," both of which were at the same elevation before retreat began.

Upon retreat of the glacier the vertical stress at the location of the "gouge" was gradually reduced to zero. The vertical stress is assumed to have a great horizontal extent, so that plane strain conditions apply.

The horizontal stress induced in the "gouge" zone and in the weathered bedrock near this zone must be equal at the vertical boundary between the two. Since the Poisson's ratio of the "gouge" is greater than that of the weathered bedrock, there will be a net horizontal movement of the vertical boundary toward the "gouge" when the ice load is removed. The reason for this movement can be explained with the aid of concepts used to understand one-dimensional compression, which is vertical compression with zero strain in both horizontal directions. In one-dimensional compression, the lateral stress,  $\sigma_h$ , is related to the vertical stress,  $\sigma_v$ , and Poisson's ration,  $\nu$ , as follows:

$$\frac{\sigma_h}{\sigma_v} = \frac{\nu}{1-\nu}$$

Hence, for various values of  $\nu$  one obtains:

$\nu$	$\sigma_h/\sigma_v$
0.1	1/9
0.3	3/7
0.5	1

The above table shows that as vertical stress is applied, the horizontal stress within the material with the higher  $\nu$ -value will tend to be

greater than in the adjacent material. Hence, the vertical boundary between two materials with different Poisson's ratio will displace toward the material with the lower  $\nu$ -value. In the case of the "gouge" and the adjacent weathered bedrock, for the stress conditions found under the continental glacier, the  $\nu$ -values are assumed, for example, to be approximately 0.4 for the "gouge" and 0.2 for the weathered bedrock. (Other assumptions may be used. The computations show that the "gouge" will be squeezed out so long as Poisson's ratio for "gouge" is greater than for the adjacent rock.) For one-dimensional stress conditions, the horizontal stress in the weathered bedrock would be  $0.25 \sigma_v$  and in the "gouge"  $0.67 \sigma_v$ . Hence the difference,  $0.42 \sigma_v$ , which in this case is about 630 to 970 psi (45 to 70 kg/cm<sup>2</sup>), causes net horizontal movement of the "gouge" toward the adjacent bedrock.

When the vertical stress is released, the opposite occurs. The weathered bedrock squeezes back against the "gouge" and causes the "gouge" to squeeze upward. The stresses resisting the upward flow of the "gouge" are the weight of the overburden and the shear stresses along the vertical boundary between the "gouge" and the weathered bedrock. The calculations (Pages D-5 to D-9, attached) show that the net effect of this process is to cause the "gouge" to squeeze upward, relative to the adjacent bedrock, about 1 to 8 in. (2.5 to 20 cm.), if the "gouge" zone retains a rectangular shape.

The behavior of the zone of higher  $\nu$ -value relative to the zone of lower  $\nu$ -value applies also for the weathered bedrock in the fault zone where no "gouge" exists. Where "gouge" does exist, there is preferential squeezing upward of that material. Where the weathered bedrock of the fault zone is more homogeneous in character, there will be a slight general rise, or upward arching, of the weathered bedrock as a result of the process described in this section. Reasonable assumptions (Page D-9 of calculations) indicate that this rise, if parabolic in shape, may be about 4 in. (10 cm.) at the middle.

#### Model 2 - Horizontal Stresses Induced by Glacier on North Side of Fault

During active retreat of the glacier, with the sea against the ice front, the southerly face of the glacier may be assumed to be very steep,

with a height of 150 to 300 ft. (50 to 100 m.) or more. The slope of the glacier surface to the north of the steep face is small and its value is of little importance to the results of the computations. At the base of this glacier there are horizontal shear stresses equal to 14 psi (1 kg/cm<sup>2</sup>).\* The combined effect of the glacier's weight and the base shear cause horizontal stresses in the bedrock which cause the "gouge" within the weathered bedrock to be subjected to a stress that tends to cause compressive failure of the plastic "gouge" zone. Given the strength of the "gouge" and the stresses applied by the ice, one can determine the likelihood of upward squeezing of the "gouge".

The horizontal stresses on the "gouge" were computed as shown on the attached calculation sheets, Pages D-10 to D-16. At a depth of 22 ft. (7 m.), the approximate depth of the top of bedrock in Trench A, the horizontal stress was found to be 150 psi (10.5 kg/cm<sup>2</sup>) and the vertical stress was found to be 35 psi (2.5 kg/cm<sup>2</sup>). This set of stresses is sufficient to cause failure of the "gouge" regardless of whether it is deemed a frictional or a cohesive material. If frictional, its friction angle must be less than 38°, and if cohesive, its shear strength, c, must be less than 55 psi (4 kg/cm<sup>2</sup>) for squeezing to occur. The friction angle of the "gouge" was measured to have a peak value of 37° and a residual value of 22°. The latter value would control for the use of the very slow process of squeezing that would take place under the conditions of this model.

---

\*Dr. Mellor (1976) from the Cold Regions Research and Engineering Laboratory in Hanover, New Hampshire, has indicated that the shear stress at the base of a glacier is 14 psi (1 kg/cm<sup>2</sup>) regardless of the thickness of the ice. That is, the stresses caused by the southerly-flowing glacier can be computed by applying a uniform horizontal shear stress of 14 psi (1 kg/cm<sup>2</sup>) at ground surface. At the front of the glacier there are blocks of ice that are not thick enough to flow. These blocks are bulldozed forward as the glacier advances, and break off as icebergs or may form kettle blocks during retreat.

Again, as in the case of Model 1, if the "gouge" does not exist at some locations along the fault, the horizontal stresses caused by the glacier would cause a more general rise, or upward curvature, of the somewhat softer weathered bedrock in the fault zone.

#### Summary and Conclusions

The squeezing out may be caused (a) during glacial retreat due to the horizontal stresses induced in the bedrock by the weight of the glacier and (b) by the heavy weight of the glacier when the face is just to the north of the weathered bedrock fault zone. This weight and the shear stress along the base combine to cause high enough lateral stress in the "gouge" to cause it to squeeze upward.

## CALCULATIONS

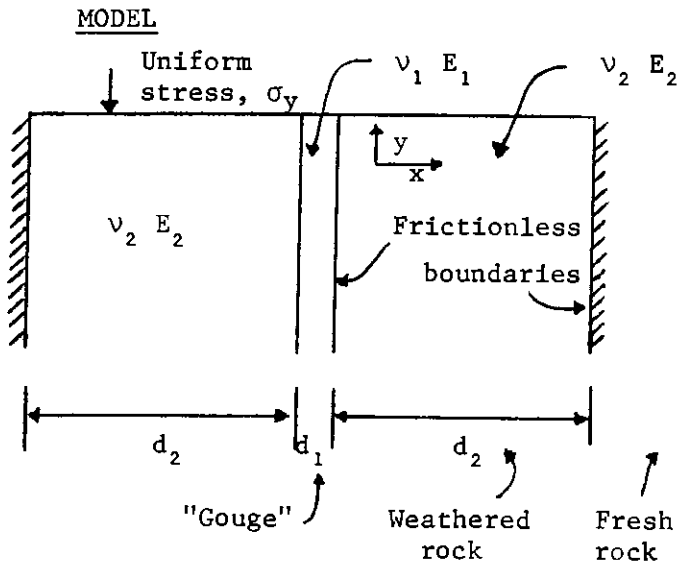
### Effect of Glacial Stresses

#### Model 1 - Locked-in Horizontal Stress

##### Assumptions:

1. The glacier is assumed to scrape the bedrock clean as the ice reaches full thickness. Thus the surface of the "gouge" and the weathered bedrock adjacent to the "gouge" are at the same level prior to melting of the ice.
2. The weathered bedrock is about 50 ft. wide. In Trench A there is a one-foot-thick "gouge" zone which is preferentially squeezed upward.
3. If the softer "gouge" zone does not exist, the upward squeezing applies to the entire zone of weathered bedrock rather than the isolated "gouge".
4. Volume increase of the "gouge" due to release of ice load is not considered herein. This effect would cause more upward squeezing than computed.
5. The rigid boundaries at the left and right on the following page represent fresh bedrock when the "gouge" is considered. If "gouge" is not present, then the rigid boundaries must be selected arbitrarily to represent the distance from the weathered zone beyond which the local effects of that zone do not extend. St. Venant's principle was used as a guide in this selection.
6. It is assumed that the squeezing upward would have begun when the "gouge" was frozen. The loading of the "gouge" is assumed to be essentially drained, in spite of the fact that the voids are ice filled, because of the extreme slowness of the in-situ process. If the process were undrained, the results are the same so long as the undrained strength of the "gouge" is less than that of the adjacent weathered bedrock.





Assumptions:

1. Plane strain
2. Frictionless boundaries
3. Load removed equivalent to 1100 to 1600 meters of ice. Ice weighs 0.9 tons/m<sup>3</sup>
4.  $\nu_1, \nu_2, E_1, E_2$  as given in computations.
5.  $d_1, d_2$ , as noted in the computations.

$\nu$  = Poisson's ratio

$E$  = Young's modulus

$\zeta$  = Normal Strain

$$(1) \quad \xi_{x1} = \frac{1}{E_1} \{ \sigma_x - \nu_1 (\sigma_y + \sigma_{z1}) \}$$

$$(2) \quad \xi_{x2} = \frac{1}{E_2} \{ \sigma_x - \nu_2 (\sigma_y + \sigma_{z2}) \}$$

$$(3) \quad \xi_{y1} = \frac{1}{E_1} \{ \sigma_y - \nu_1 (\sigma_x + \sigma_{z1}) \}$$

$$(4) \quad \xi_{y2} = \frac{1}{E_2} \{ \sigma_y - \nu_2 (\sigma_x + \sigma_{z2}) \}$$

$$(5) \quad \xi_{z1} = 0 = \frac{1}{E_1} \{ \sigma_{z1} - \nu_1 (\sigma_x + \sigma_y) \}$$

$$(6) \quad \xi_{z2} = 0 = \frac{1}{E_2} \{ \sigma_{z2} - \nu_2 (\sigma_x + \sigma_y) \}$$

$$(7) \quad \xi_{x1} d_1 = -2 \xi_{x2} d_2 \quad (\text{Since lateral movement at "gouge"/rock interface must be the same.})$$

Unknowns:  $\xi_{x1}, \xi_{x2}, \sigma_x, \sigma_{z1}, \sigma_{z2}, \xi_{y1}, \xi_{y2}$

Given:  $\xi_{z1} = \xi_{z2} = 0$   
 $\sigma_{x1} = \sigma_{x2} = \sigma_x$

$\sigma_y$  is uniform

$\nu_1, \nu_2, E_1, E_2$

$d_1, d_2$  to be assumed

$\xi_{x1}, \xi_{x2}$  are uniform

in lateral direction.

Solve above equations for  $\xi_{x2}$  so that one can compute horizontal displacement at interface between weathered rock and "gouge", and hence the squeezing upward that would occur.

Solution:

Solve Eq. (5) and Eq. (6) for  $\sigma_{z1}$  and  $\sigma_{z2}$  and substitute into Eq. (1) and Eq. (2).

$$(8) \quad \xi_{x1} = \frac{1}{E_1} \{ \sigma_x - \nu_1 (\sigma_y + \nu_1 \sigma_x + \nu_1 \sigma_y) \}$$

$$(9) \quad \xi_{x2} = \frac{1}{E_2} \{ \sigma_x - \nu_2 (\sigma_y + \nu_2 \sigma_x + \nu_2 \sigma_y) \}$$

Divide above equations

$$\frac{\xi_{x1}}{\xi_{x2}} = \frac{E_2 \{ \sigma_x - \nu_1 (\sigma_y + \nu_1 \sigma_x + \nu_1 \sigma_y) \}}{E_1 \{ \sigma_x - \nu_2 (\sigma_y + \nu_2 \sigma_x + \nu_2 \sigma_y) \}} = - \frac{2 d_2}{d_1} \quad \text{From Eq. (7)}$$

Solve for  $\sigma_x$

$$\sigma_x - \nu_1 (\sigma_y + \nu_1 \sigma_x + \nu_1 \sigma_y) = - \frac{2 d_2 E_1}{d_1 E_2} \{ \sigma_x - \nu_2 (\sigma_y + \nu_2 \sigma_x + \nu_2 \sigma_y) \}$$

$$\text{let } \frac{2 d_2 E_1}{d_1 E_2} = A$$

$$\sigma_x - \nu_1^2 \sigma_x + A \sigma_x - A \nu_2^2 \sigma_x = + \nu_1 (\sigma_y + \nu_1 \sigma_y) + A \nu_2 (\sigma_y + \nu_2 \sigma_y)$$

$$(10) \quad \sigma_x = \sigma_y \left[ \frac{\nu_1 (1 + \nu_1) + A \nu_2 (1 + \nu_2)}{1 - \nu_1^2 + -A \nu_2^2 + A} \right]$$

Let quantity in bracket be B, and substitute Eq. (10) into Eq. (9)

$$\xi_{x2} = \frac{\sigma_y}{E_2} \{ B - \nu_2 (1 + B \nu_2 + \nu_2) \}$$

$$(11) \quad \xi_{x2} = \frac{\sigma_y}{E_2} \{ B(1 - \nu_2^2) - \nu_2(1 + \nu_2) \}$$

As a check on correctness of Eq. (10), let  $\nu_1 = \nu_2$  to determine whether ratio of stresses is correct as for one-dimensional compression.

$$\begin{aligned} \sigma_x &= \sigma_y \left[ \frac{\nu(1 + \nu) + A \nu(1 + \nu)}{1 - \nu^2 + A(1 - \nu^2)} \right] \\ &= \sigma_y \frac{\nu(1 + \nu) (1 + A)}{(1 - \nu^2) (1 + A)} \\ &= \sigma_y \frac{\nu (1 + \nu)}{(1 + \nu) (1 - \nu)} \\ \sigma_x &= \sigma_y \frac{\nu}{1 - \nu} \quad \text{QED} \end{aligned}$$

The total lateral movement of the weathered rock mass due to application or removal of a uniform vertical stress,  $\sigma_v$ , is given by:

$$\delta_h = 2 d_2 \xi_{x2}$$

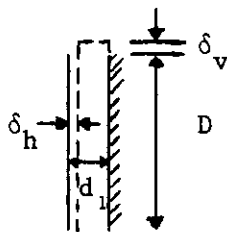
Hence, from Eq. (11)

$$(12) \quad \delta_h = \frac{2 d_2 \sigma_v}{E_2} \{B(1 - \nu_2^2) - \nu_2(1 + \nu_2)\}$$

where:

$$B = \frac{\nu_1(1 + \nu_1) + A \nu_2(1 + \nu_2)}{(1 - \nu_1^2) + A(1 - \nu_2^2)} \quad \text{and} \quad A = \frac{2 d_2 E_1}{d_1 E_2}$$

To calculate the upward movement of "gouge" due to removal of vertical load, assume that the "gouge" does not change in volume over a depth  $D$  as the ice load is removed. Then the volume displaced due to lateral movement  $\delta_h$  must equal volume occupied by material that is squeezed upward.



Hence: Volume displacement =  $D \delta_h = (d_1 - \delta_h) \delta_v$

$$(13) \quad \text{or} \quad \delta_v = \frac{D}{\left(\frac{d_1}{\delta_h} - 1\right)}$$

In this equation it is assumed that the extruded material has a rectangular section.

To compute  $\delta_v$ , compute  $\delta_h$  from Eq. (12) and substitute into Eq. (13).

The above Eqs. (12) and (13) were used together with the assumed values listed below to compute  $\delta_v$  values.

Case	$\nu_1$	$\nu_2$	$d_1$	$d_2$	$E_1$	$E_2$	$\sigma_y$	D	A	B	$\delta_h$	$\delta_v$
	-	-	ft	ft	psi	psi	psi	ft	-	-	in	in
(a)	0.4	0.2	1	25	$10^4$	$6 \times 10^5$	3500	10	0.83	0.46	0.72	7.7
(b)	0.4	0.2	1	25	$10^5$	$6 \times 10^5$	3500	10	8.33	0.29	0.13	1.3
(c)	0.4	0.2	1	25	$10^4$	$10^6$	3500	10	0.50	0.25	0.52	5.4
(d)	0.4	0.2	1	25	$10^4$	$6 \times 10^5$	2000	10	0.83	0.46	0.40	4.1
(e)	0.3	0.1	0.7	25	$10^4$	$10^6$	3500	10	0.71	0.34	0.24	3.5
(f)*	0.2	0.1	50	500	$6 \times 10^5$	$3 \times 10^6$	3500	500	4.00	0.14	0.37	3.7

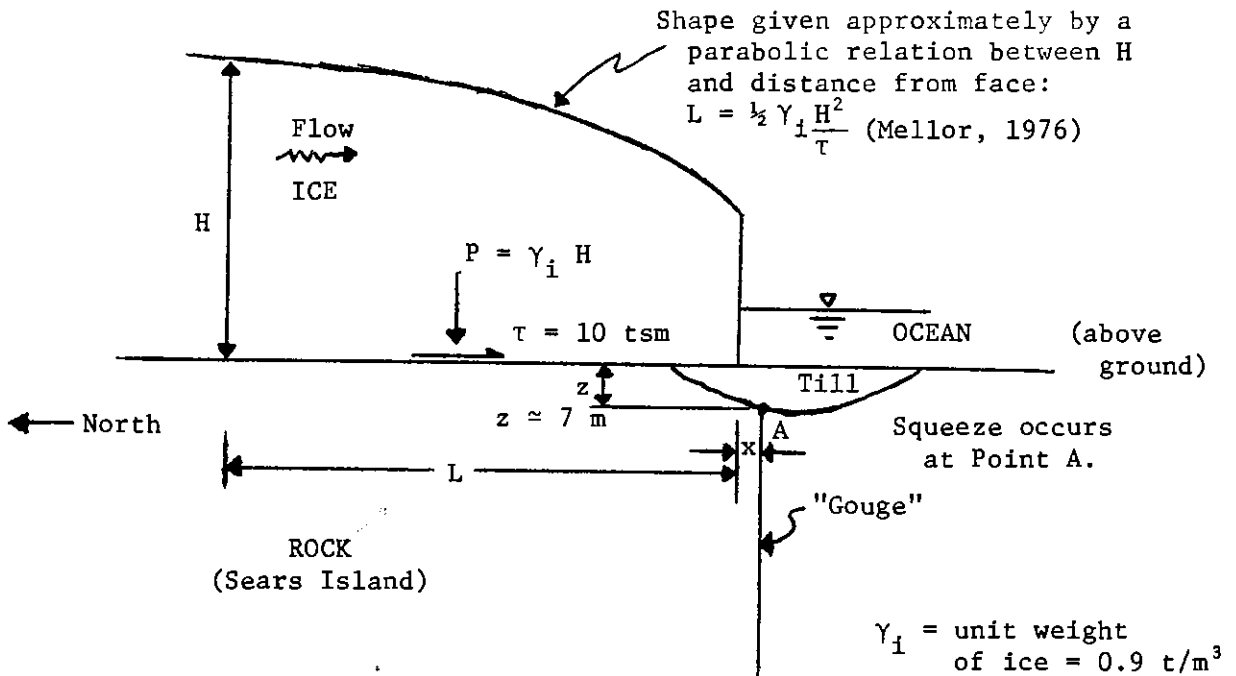
\* Case (f) is based on assumption of 50 ft wide weathered rock zone without "gouge" contained.

Effect of Glacial Stresses

Model 2 - Glacier North of Weathered Bedrock Fault Zone

Model description and assumptions:

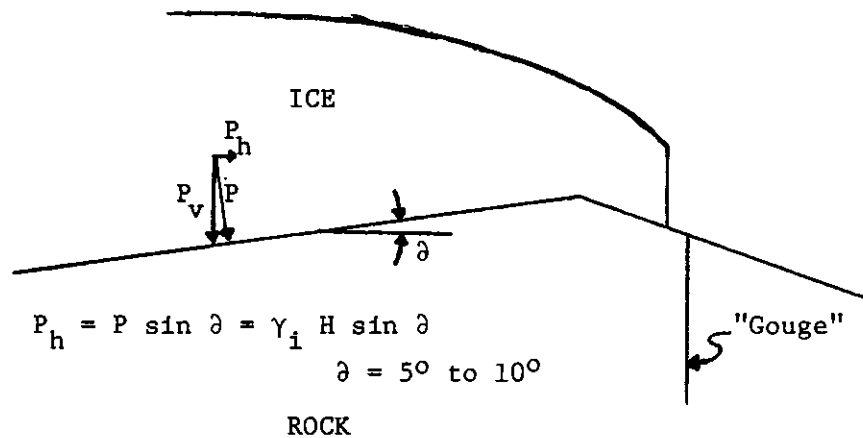
1. The glacier is assumed to lie just north of the weathered bedrock fault zone. The stresses on the "gouge" due to the weight of ice over a half-space of elastic material, due to base shear, and due to topographic effects are computed separately. The computations are made for a depth of 7 m. (22 ft.), which is the approximate depth to the top of "gouge".
2. The horizontal stresses, being larger than the vertical stresses at the "gouge", cause upward squeezing, particularly, if they are high enough to cause failure of the "gouge" in shear.
- 3.



The height of the advancing face is assumed to be vertical and about 50 to 100 m. high. The slope of the top of glacier is shallow and does not affect the stresses at the "gouge" appreciably. Hence, the top is assumed horizontal.



4. The shape of the island topography relative to the weathered bedrock fault zone is such as to cause an additional source of horizontal stress at the fault zone.



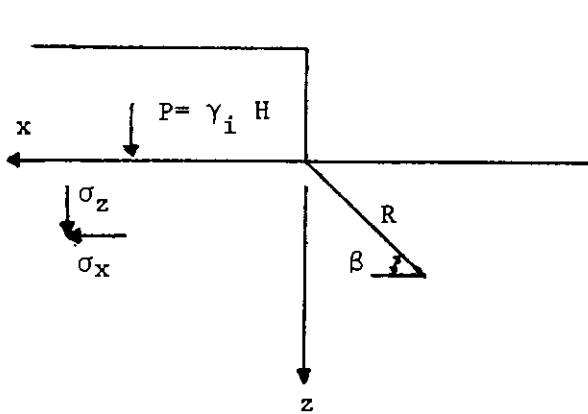
The stress  $P$  is hydrostatic. Its horizontal component causes a stress against the "gouge". The horizontal stress at the "gouge" is due to both the vertical and horizontal components. The effect of the vertical component is computed separately.

5. For convenience, metric units are used in these computations.

$$\begin{aligned} \gamma_i &= 0.9 \text{ tons/m}^3 \quad (1 \text{ ton} = 1000 \text{ kg}). \quad \text{Density of ice.} \\ \tau &= 10 \text{ tons/m}^2 \quad (\text{tsm}). \quad \text{Shear at base of glacier.} \\ &= 1 \text{ kg/cm}^2 \approx 1 \text{ ton/ft}^2 \quad (\text{tsf}) \\ z &= 7 \text{ m } (\sim 22 \text{ ft}) \end{aligned}$$

6. The vertical stress in the ground with glacier absent is assumed equal to the overburden,  $\sigma_z$  and, in the horizontal direction, equal to  $K_o \sigma_z$ .

A. Vertical and horizontal stresses due to weight of ice.



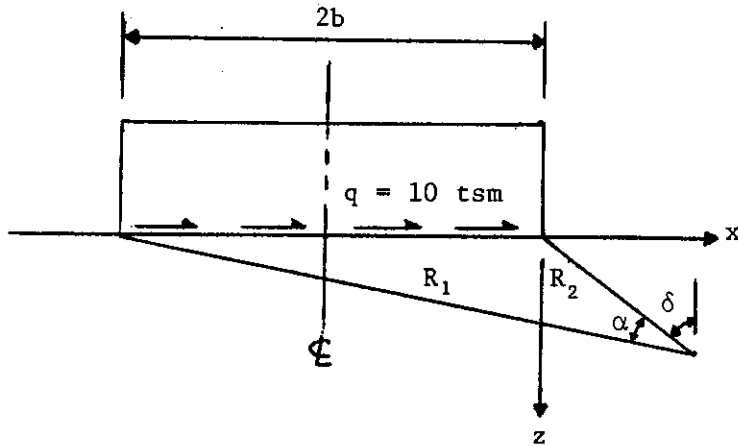
$$\sigma_z = \frac{P}{\pi} \left( \beta + \frac{xz}{R^2} \right)$$

$$\sigma_x = \frac{P}{\pi} \left( \beta - \frac{xz}{R^2} \right)$$

$$z = 7 \text{ m} \quad \beta = \tan^{-1} \left( \frac{z}{x} \right) \quad R^2 = x^2 + z^2$$

x (m)	$\beta$ (-)	$\frac{xz}{R^2}$ (-)	$\frac{\sigma_z}{P} = \frac{1}{\pi} \left( \beta + \frac{xz}{R^2} \right)$ (-)	$\frac{\sigma_x}{P} = \frac{1}{\pi} \left( \beta - \frac{xz}{R^2} \right)$ (-)
0	$\pi/2$	0	0.50	0.50
-5	0.95	-0.47	0.15	0.45
-10	0.61	-0.47	0.04	0.34
-20	0.34	-0.31	0.01	0.21
-30	0.23	-0.22	0	0.14

B. Vertical and horizontal stresses due to shear at base of ice.



$$\sigma_z = \frac{q}{\pi} \{ \sin \alpha \sin (\alpha + 2\delta) \}$$

$$\sigma_x = \frac{q}{\pi} \left\{ \ln \frac{R_1^2}{R_2^2} - \sin \alpha \sin (\alpha + 2\delta) \right\}$$

$$\delta = \tan^{-1} \left( \frac{x}{z} \right) \quad \alpha = \left[ \tan^{-1} \left( \frac{z}{x} \right) - \tan^{-1} \left( \frac{z}{x + 2b} \right) \right] \quad z = 7 \text{ m}$$

Let  $2b = 200 \text{ km} = 2 \times 10^5 \text{ m}$  (4 times crust thickness)

$$R_1 = \sqrt{z^2 + (x + 2b)^2} \quad R_2 = \sqrt{z^2 + x^2}$$

x (m)	$\alpha$ (deg)	$\delta$ (deg)	$\alpha + 2\delta$ (deg)	$\frac{1}{\pi} \ln \left( \frac{R_1}{R_2} \right)^2$	$\frac{\sigma_z}{q} = \frac{1}{\pi} \{ \sin \alpha \sin (\alpha + 2\delta) \}$	$\frac{\sigma_x}{q} = \frac{1}{\pi} \ln \left( \frac{R_1}{R_2} \right)^2 - \frac{\sigma_z}{q}$
0	90	0	90	6.53	0.32	6.21
5	54.46	35.54	125	6.40	0.21	6.19
10	34.99	55.01	145.01	6.18	0.10	6.08
20	19.29	70.71	160.71	5.83	0.03	5.80
30	13.13	76.87	166.86	5.59	0.02	5.57

C. Horizontal stress due to topographic relief.

The stress at the "gouge" is assumed equal to the horizontal component of the hydrostatic stress due to the weight of the glacier. The effect of this component is to increase the horizontal stress that is induced beneath a horizontal surface. Since this stress would act for a long period, and since only small deformation would be needed to develop this stress in the "gouge", the assumption seems reasonable.

The thickness of ice that controls this component of the horizontal stress is the thickness that exists on the north side of the high point of the island at the same ground elevation as the top of the "gouge" zone. Since the distance from the weathered bedrock fault zone to the middle of the north slope is about 1.0 km. (=1000 m), the ice thickness can be estimated from (according to M. Mellor):

$$L (= 1000 \text{ m}) = \frac{1}{2} \frac{\gamma_i}{\tau} H^2$$

where  $\gamma_i = 0.9 \text{ t/m}^3$  and  $\tau = 10 \text{ tsm}$

$$H = \sqrt{\frac{2\tau L}{\gamma_i}} = \sqrt{\frac{2 \times 10 \times 1000}{0.9}} = 150 \text{ m.}$$

Hence the horizontal component of the ice weight is:

$$P_h = \gamma_i H \sin \theta \quad \text{Let } \theta = 2^\circ \quad \gamma_i = 0.9 \quad H = 150 \text{ m.}$$

$$P_h = 4.7 \text{ tsm}$$

D. Horizontal and vertical stress due to overburden alone:

$$\sigma_z = \gamma z = \frac{140}{62.4} \times 7 = 15.7 \text{ tsm}$$

$$\sigma_x = K_o \sigma_z = 0.5 \sigma_z = 7.8 \text{ tsm}$$

Sum the horizontal and vertical stresses at "gouge" at  $z = 7$  m.

1.  $\sigma_x$  - values

x (m)	$P_{50}$ (tsm)	q (tsm)	Topo (tsm)	$K_o$ (tsm)	$\Sigma \sigma_x$ (tsm)	
0	22.5	62.1	4.7	7.8	97	$P_{50}$ = Stresses due to 50 meter high face of ice.
5	20.3	61.9	4.7	7.8	95	
10	15.3	60.8	4.7	7.8	89	
20	9.5	58.0	4.7	7.8	80	
30	6.3	55.7	4.7	7.8	74	

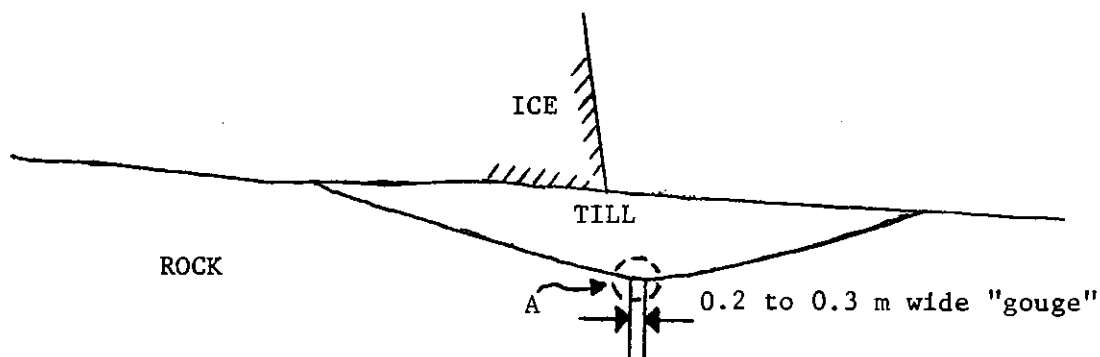
2.  $\sigma_z$  - values

x (m)	$P_{50}$ (tsm)	q (tsm)	Topo (tsm)	Overburden (tsm)	$\Sigma \sigma_z$ (tsm)	$\Sigma \sigma_x / \Sigma \sigma_z$ -	$\Sigma \sigma_x - \Sigma \sigma_z$ (tsm)
0	22.5	3.2	0	15.7	41	2.37	46
5	6.7	2.1	0	15.7	25	3.80	70
10	1.8	1.0	0	15.7	19	4.68	70
20	0.5	0.3	0	15.7	17	4.71	63
30	0	0.2	0	15.7	16	4.63	58

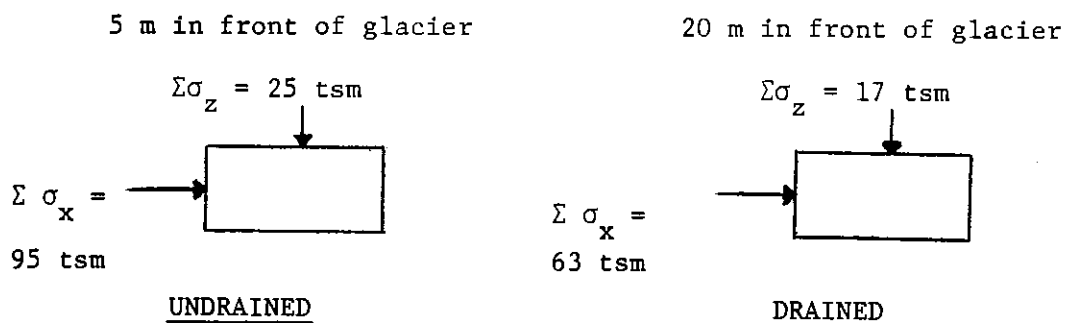
- Conclusions:
1. The maximum principal stress difference of 70 tsm (7.0 tsf) occurs about 5 m. in front of the glacier.
  2. The maximum principal stress ratio of 4.71 occurs about 20 m. in front of the glacier.



Comparison of Shear Stress at "Gouge" with Its Strength.



The stress conditions at point A above are given above for various distances in front of the toe of the glacier. To determine whether extrusion will occur, consider the stress conditions on a "specimen" of "gouge" taken from point A:



In drained shear, the most critical condition arises when the principal stress ratio is a maximum. In this case the maximum is 4.71, which represents a friction angle of  $41^\circ$ . The peak value measured for the "gouge" was  $38^\circ$  and the residual value, which probably controls, was  $22^\circ$ . Hence, failure in drained shear is very likely to occur.

In undrained shear the maximum principal stress difference controls. The computed value 5 m. in front of the glacier is 70 tsm (7.0 tsf), which is greater than one could expect the "gouge" to display in undrained shear. The ice itself, which fills the voids, has an "undrained" strength of only 10 tsm.

## APPENDIX E

### General Discussion of Glaciotectonics, Rebound Effects, and Postglacial Faulting

Unusual geologic structures attributable to continental glaciation are well known in North America and Europe. Some of the best examples of "glaciotectonics" or ice shove, are found at Gay Head on Martha's Vineyard and Møns Klint in Denmark (Schafer and Hartshorn, 1965). Ice shove is only one type of deformation, however. Occhietti (1973) lists several types of deformations caused by glaciers:

- 1) Glaciotectonic deformations in the glacier's substratum,
- 2) Glaciodynamic primary structures in the ground moraine,
- 3) Deformations in glacial till and upper parts of the substratum produced by pressure from stagnant ice,
- 4) Glacio-karstic terrain produced by fusion of buried glacial ice masses, and
- 5) Deformations produced by dragging icebergs on the bottom of what was once the sea or a glacial lake.

Moran (1971) describes several types of glacial ice shove features. Shearing at the base of the glacier can result in inclusion of large slices of bedrock up to 230 feet (70 m) thick into the moving ice. Some of these large scale block inclusions seem to result from high pore pressure buildup in strata of weak shear strength near the bottom of the glacier. Simple "in-situ" deformation (such as drag folding) and transportational stacking within single till sheets are common. Mills and Wells (1974) discuss ice shove deformation at Port Washington, Long Island. From the study of the type of deformation that occurred in the stratigraphic units, they infer that some units were deformed while in a frozen state. Evenson (1971), in his discussion of till fabric mentions that others have shown that continental ice movement can cause re-orientation of the fabric elements to a depth of 35 ft. (11 m.) in over-ridden deposits. Features found at Cleveland Illuminating's Perry

Nuclear Site were apparently created by ice shove.

The relationship between glacial rebound and postglacial fault movement is not nearly as well studied as glacial ice shove. There is no case described in the literature in which fault movement is clearly shown to have been a result of glacial loading or unloading. In the "punching" or "hingeline" model of earth response to glacial loading, one can infer that fault movement may have occurred. In the forebulge hypothesis and in Broecker's (1966) model, fault movement is not assumed in the ideal case. Kupsch (1967) discusses the various aspects of the punching versus forebulge hypotheses. Newman, Fairbridge and March (1971) as well as many other recent investigators, seem to favor the forebulge concept although it has still not been proved to the satisfaction of many investigators.

In any of the rebound models, a progressive uplift of the land occurs during deglaciation that begins near the ice margin and moves back with the glacier at a rate of about 330 to 980 feet (100 to 300 meters) per year (Newman and others, 1971; Brotchie and Sylvester, 1969; Stuiver and Borns, 1975). Given the facts that the land on the proximal edge of the glacier is depressed while the distal side is rising and the elastic portion of total rebound is on the order of meters, it appears reasonable to assume that differential movements will occur along weak shear zones in the earth's crust if they ran approximately parallel to the retreating ice front and the shear strength at the fault is low enough. Friction losses across a weak shear plane would leave the distal side higher than the proximal side.

Quedemann (1970) proposed that some high angle reverse faults are, in fact, related to this rebound process. All small high-angle post-glacial reverse faults mentioned in Sbar and Sykes (1973), Lawson (1911), and Matthew (1894) have two features in common. (1) They all occur in shales, slates and phyllites, usually with a well developed steeply dipping cleavage striking somewhat perpendicular to major direction of ice movement. (2) The faults are usually a set of small, closely spaced thrust faults controlled by cleavage with the block on the distal side of the glacial front thrown up relative to the proximal side.

The field evidence at Sears Island does not indicate post-glacial reverse faulting. As explained in Appendix D, the Sears Island features can be explained as plastic movements of the "gouge" up into the till and uparching of the weathered bedrock in the bottom of the trenches in response to horizontal stresses that exceeded vertical stresses. In the other cases described in the previous paragraph, however, it seems possible that non-tectonic fault movement could, in fact, have occurred during rebound where properly oriented regional discontinuities weak in shear were present.

If the crustal earth flexure during rebound did superimpose movement on ancient faults, it is not a present earthquake-inducing force. See Section III.4 of this report.